

FM Stereo in Hi-Fi Packages

APRIL

Radio-Electronics

TELEVISION • SERVICING • HIGH FIDELITY

HUGO GERNSBACK, Editor-in-chief

50c

**Improve Your TV
Picture and Sound**

**Build a Sensitive
Light Meter**

**Don't Let
Transients
Wreck
Your Meter**

**Signal Injector
Improves Your VTVM**

**Electronic Toys Become
Real Training Equipment**

See page 31 ▶

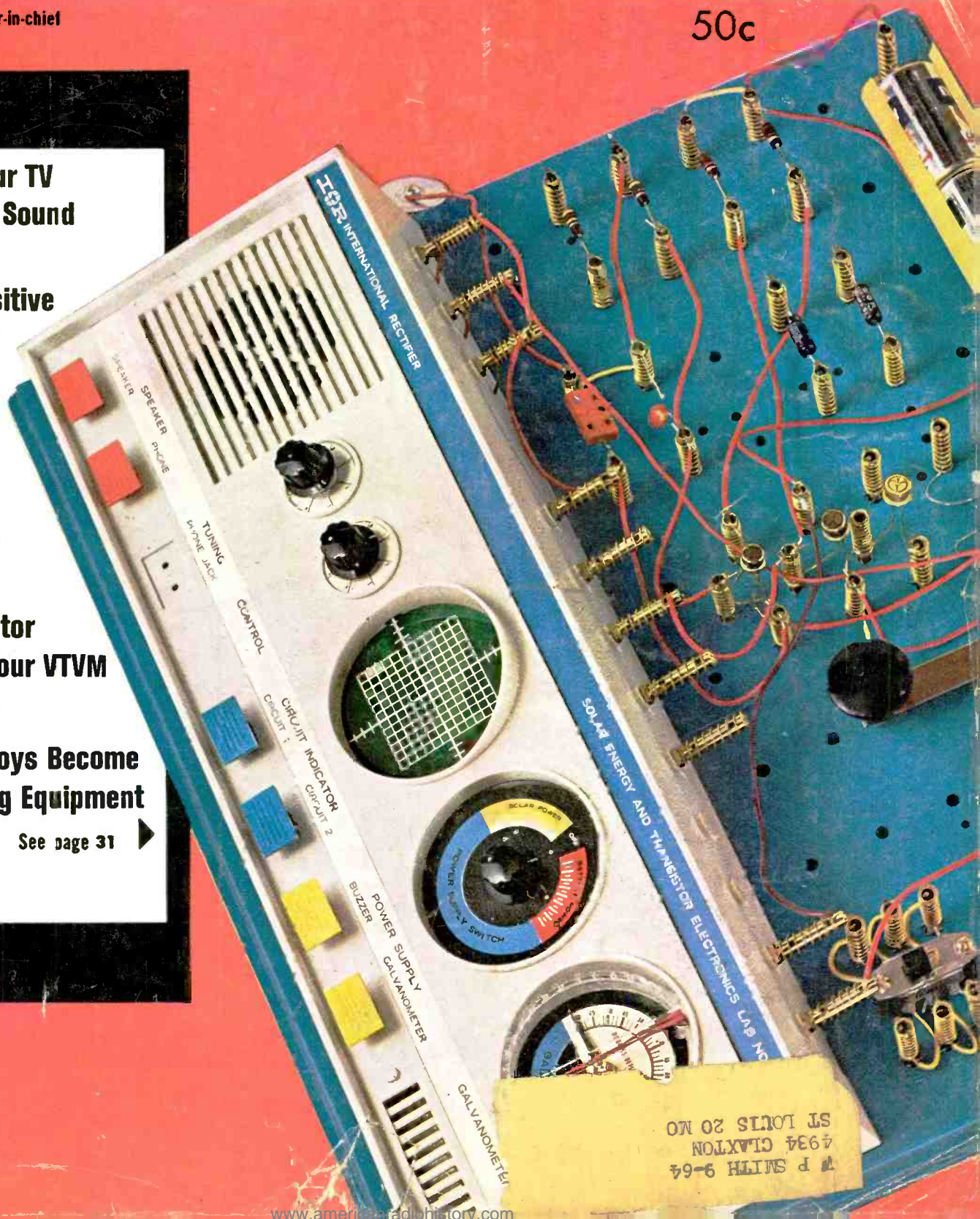

**WORLD'S LARGEST SELLING
AND WORLD'S NEWEST**

Hand Size V-O-M's



MODEL 310
World's Largest Selling
Volt-Ohm-Milliammeter

MODEL 310-C
World's Newest
Volt-Ohm-Milliammeter



**BOTH TESTERS
SHOWN
ACTUAL SIZE**

- 1** **HAND SIZE AND LIGHTWEIGHT**, but with the features of full-size V-O-M's.
- 2** **20,000 OHMS PER VOLT DC; 5,000 AC (310)—15,000 AC (310-C).**
- 3** **EXCLUSIVE SINGLE SELECTOR SWITCH** speeds circuit and range settings. The first miniature V-O-M's with this exclusive feature for quick, fool-proof selection of all ranges.

SELF-SHIELDED Bar-Ring instrument; permits checking in strong magnetic fields. FITTING INTERCHANGEABLE test prod tip into top of tester makes it the common probe, thereby freeing one hand. UNBREAKABLE plastic meter window. BANANA-TYPE JACKS—positive connection and long life.

Model 310—\$37.50 Model 310-C—\$44.50 Model 369 Leather Case—\$3.20

ALL PRICES ARE SUGGESTED U.S.A. USER NET, SUBJECT TO CHANGE

THE TRIPLETT ELECTRICAL INSTRUMENT COMPANY, BLUFFTON, OHIO

310-C PLUS FEATURES

1. Fully enclosed lever range switch
2. 15,000 Ohms per volt AC (20,000 O/V DC same as 310)
3. Reversing switch for DC measurements

MODELS 100 AND 100-C

Comprehensive test sets. Model 100 includes: Model 310 V-O-M, Model 10 Clamp-on Ammeter Adapter; Model 101 Line Separator; Model 379 Leather Case; Model 311 leads. (\$67.10 Value Separate Unit Purchase Price.)

MODEL 100—U.S.A. User Net. \$64.50
MODEL 100-C—
Same as above, but
with Model 310-C.
Net.\$71.50



USES UNLIMITED: FIELD ENGINEERS • ELECTRICAL, RADIO, TV, AND APPLIANCE SERVICEMEN • ELECTRICAL CONTRACTORS • FACTORY MAINTENANCE MEN • ELECTRONIC TECHNICIANS • HOME OWNERS, HOBBYISTS
THE WORLD'S MOST COMPLETE LINE OF V-O-M'S • AVAILABLE FROM YOUR TRIPLETT DISTRIBUTOR'S STOCK

A NEW LOW-PRINT MASTERING TAPE WITH NO SACRIFICE IN OUTPUT!

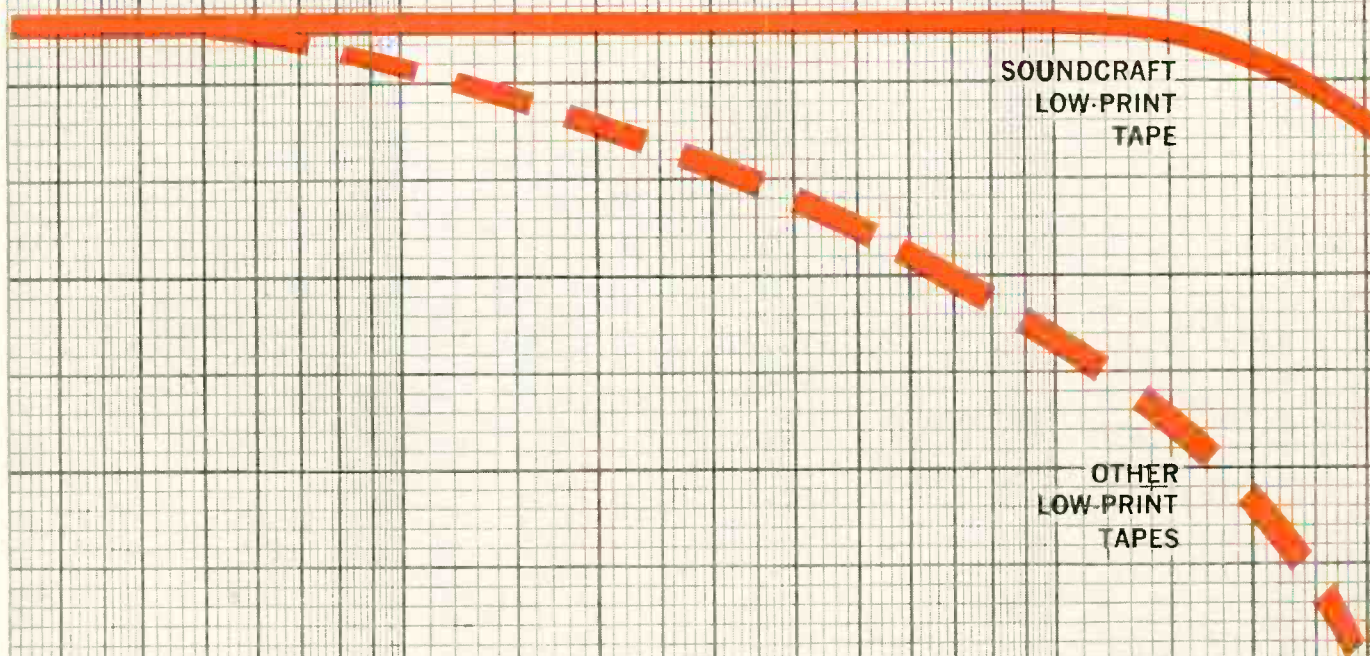

Gives you a bonus of 5 db greater high frequency output than any other low-print tape!



Now, for the first time — a professional low-print mastering tape you can intersplice with standard mastering tapes because **its output characteristics match these tapes!** To achieve this, Soundcraft has provided this tape with a high frequency boost . . . 5 db more output than other competitive low-print tapes . . . to assure you of master recordings with lower background noise and wider dynamic range. All this, in a tape that offers 8 db better print-through than standard mastering tapes. No static noise, no editing squeal. Exclusive Soundcraft manufacturing processes help to produce a physically perfect tape — among these:

- Micropolishing® for mirror-smooth defect free surface, perfect high frequency response without break-up.
- Precision-slitting for complete absence of edge burrs and skew.
- Chemical balance of base material and oxide coating to prevent cupping.



And two more Professional Tapes to improve your recordings:

SOUNDCRAFT HIGH OUTPUT MASTERING TAPE — Provides optimum combination of high output, high signal to noise and low distortion characteristics — resulting in wider dynamic range for your critical master recordings.

SOUNDCRAFT DUPLICATING TAPE — Has 25% greater high frequency output and 7 db better signal to noise ratio than conventional duplicating tapes. Used throughout the industry when quality reproduction is required.

Write for your free "Guide to Soundcraft Professional Recording Products".

REEVES **SOUNDCRAFT** CORP.

Main Office: Great Pasture Road, Danbury, Connecticut • New York: 10 E. 52nd Street • Chicago: 28 E. Jackson Blvd. • Los Angeles: 342 N. LaBrea • Canadian Reps.: Toronto, Vancouver

Radio-Electronics

APRIL 1963
VOL. XXXIV No. 4

Formerly RADIO CRAFT—Incorporating SHORT WAVE CRAFT—TELEVISION NEWS—RADIO & TELEVISION*

editorial

Hugo Gernsback 23 The Electronic Revolution

audio-high fidelity-stereo

Glen R. Travis 24 Try Fixed Bias in all Stages
You'll end up with an excellent hi-fi system

Robert F. Scott 32 FM Stereo in Hi-Fi Packages
How Motorola, Zenith and RCA include stereo circuitry

J. A. Maddox 45 Automated Multiplex
Make your adapter hide-away-able

Anthony Prasil 58 Puzzled About Hum?
How to keep it out of preamps

electronics

E. H. Leftwich 28 Watch Out for Transients
They'll get your meter and diodes if you're not careful

31 New Scientific Toys Teach Kids to Think (Cover Feature)

48 Sensitive Light Meter is Easy to Build
Simple but highly accurate 3-range instrument

general

Dexter S. Bartlett 35 Inventors of Radio—Nikola Tesla

Jack Darr 40 Holes and the Service Technician
How to drill and punch holes in metal, wood and concrete

44 What's Your EQ?

radio

Arnold W. Wiegert 27 Unusual Squelch Troubles
Mobile radio can be a service problem

John T. Frye, W9EGV 36 Good Little Indian—The Mohican
Hot little 10-transistor short-wave receiver

television

26 Is There an Answer?

Mohammed Ulysses Fips 43 Teleyeglasses

Daniel Marcek 46 Improve Your TV Picture and Sound
Do it yourself for better viewing

Jack Darr 52 Service Clinic
Quick-check capacitors

Wm. Darragh 64 Keep Your Scope Linear
It isn't hard to do if you know what to look for

test instruments

Harold Reed 30 Build a Signal Injector Into Your Vtvm
Makes your meter a complete servicing tool

I. Queen 50 Oscamp—An Ac Bridge
One-evening construction project

E. C. Carlson 51 Panel Meters Need a Home

George Mordwinkin 60 Equipment Report
New Low-Cost FM Stereo Generator
The Karg MX-1G

the departments

34 Correction
17 Correspondence
102 New Books

93 New Literature
99 New Patents
70 New Products

87 New Semiconductors & Tubes
6 News Briefs
100 Noteworthy Circuits

90 Technicians' News
94 Techniques
96 Try This One

Over 55 Years
of Electronic Publishing

EDITOR-IN-CHIEF AND PUBLISHER

Hugo Gernsback

EDITOR

M. Harvey Gernsback

MANAGING EDITOR

Fred Shunaman

TECHNICAL EDITOR

Robert F. Scott, W2PWC

EDITORIAL ASSOCIATE

I. Queen

EDITORIAL ASSISTANT

Ramona Goldman

SERVICE EDITOR

Jack Darr

TECH. ILLUSTRATION DIRECTOR

Wm. Lyon McLaughlin

ART ASSOCIATE

Fred Neinast

DIRECTOR OF PRODUCTION

Elizabeth Stalcup

DIRECTOR, ADVERTISING SALES

Frank T. Baker

EASTERN SALES MANAGER

John J. Lamson

CIRCULATION MANAGER

G. Aliquo

DIRECTOR, NEWSSTAND SALES

Joseph L. Bund



Average Paid Circulation
Over 160,000

—on the cover—

(More on page 31)

This representative of the new scientific toys, that educate while they teach, is the International Rectifier Corp. Lab No. 3.

Color original by
Habershaw Studios

Gernsback Publications, Inc.

EXECUTIVE, EDITORIAL, ADVERTISING OFFICES

154 W. 14 St., New York 11, N.Y.
Telephone AL 5-7755

CHAIRMAN OF THE BOARD

Hugo Gernsback

PRESIDENT

M. Harvey Gernsback

SECRETARY

G. Aliquo



Radio-Electronics is indexed in
Applied Science & Technology Index
(Formerly Industrial Arts Index)

*Trademark registered U. S. Pat. Office

A NEW WORLD OF OPPORTUNITY AWAITS YOU WITH N.T.S. ALL-PHASE HOME TRAINING IN ELECTRONICS



You can install and maintain electronic circuitry in missiles and rockets . . . specialize in micro-waves, radar and sonar.

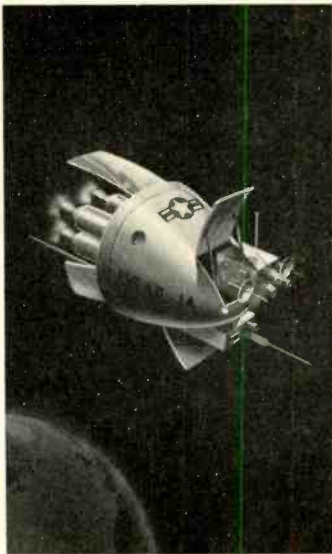

You can succeed in TV-Radio Communications . . . prepare for F.C.C. License, service advanced satellites for industry and defense.



You can service and repair the electronic "brains" of industry — computers, data processing, and other automation equipment.

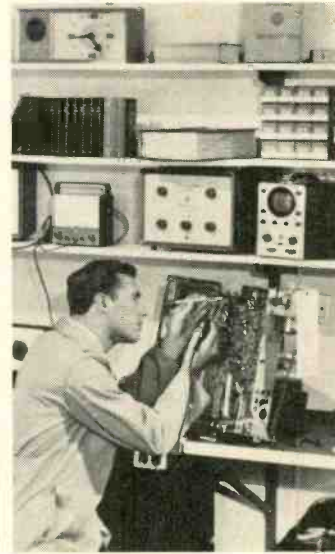

You can become a highly-paid TV-Radio Technician, an electronics field engineer, or succeed in your own sales & service business.

The N.T.S. Master Course enables you to do more, earn more in ELECTRONICS • TELEVISION • RADIO Yet N.T.S. Training costs no more than other courses far less complete

There's a good reason why N.T.S. Master-Training opens a wide new world of opportunity for you in Electronics, Television, Radio.

Everything you learn, from start to finish, can be applied directly to all phases of the Electronics Industry.

As a result, the N.T.S.-Trained Technician can move ahead faster, in any direction — from TV-Servicing to Radio Communications to Space-Missile Electronics and Automation for industry and defense. You can go wherever pay is highest and opportunity unlimited.

Electronic circuitry, for example, is one of science's miracles that is basic to the entire field of Electronics. It is used in satellites, computers and space capsules as well as in today's television sets and high fidelity equipment. N.T.S. shows you how to service and repair electronic circuitry for all electronic applications.

You work on many practical job projects. You build a short-wave, long-wave superhet receiver, plus a large-screen television set from the ground up. N.T.S. training kits contain all the parts you need . . . at no extra cost. (See box at right.) You also receive a professional Multitester to use during training and on the job.

ONE LOW TUITION. You need training related to all phases of Electronics. Industry demands it. Only N.T.S. provides it . . . in ONE Master Course at ONE low tuition.

RESIDENT TRAINING AT LOS ANGELES

If you wish to take your Electronics-TV-Radio training in our famous Resident School in Los Angeles — the oldest and largest school of its kind in the world — write for special Resident School catalog and information, or check coupon.



NATIONAL TECHNICAL SCHOOLS

WORLD-WIDE TRAINING SINCE 1905
4000 So. Figueroa St., Los Angeles 37, Calif.

Accredited Member N.T.S.C.



YOU ENROLL BY MAIL AND SAVE MONEY. No salesmen means *lower costs for us, lower tuition for you.*

START NOW. A whole new world of opportunity awaits the man with Electronic Home-Training from National Technical Schools — a recognized leader in technical training for 58 years.



19 BIG KITS
YOURS TO KEEP



MAIL COUPON NOW FOR FREE BOOK AND ACTUAL LESSON!

NO OBLIGATION.
NO SALESMAN WILL CALL.

NATIONAL TECHNICAL SCHOOLS

WORLD-WIDE TRAINING SINCE 1905

**National Technical Schools, Dept. RG-43
4000 S. Figueroa St., Los Angeles 37, Calif.**

Please Rush FREE Electronics-TV-Radio "Opportunity" Book and Actual Lesson. No Salesman Will Call.

Name _____ Age _____

Address _____

City _____ Zone _____ State _____

Check if interested ONLY in Resident Training at L.A.

High school home study courses also offered. Check for free catalog.

RADIO-ELECTRONICS published monthly at Concord, N. H., by Gernsback Publications Inc. Second-class postage paid at Concord, N. H. Copyright © 1963, by Gernsback Publications Inc. All rights reserved under Universal, International and Pan-American Copyright Conventions. SUBSCRIPTION RATES: U.S. and possessions, Canada: \$5 for 1, \$9 for 2, \$12 for 3 years. Pan-American countries: \$6 for 1, \$11 for 2, \$15 for 3 years. Other countries: \$6.50 for 1, \$12 for 2, \$16.50 for 3 years. Postmaster send form 3579 to 154 W. 14th St., New York 11, N. Y.

News Briefs

Telstar Reports on Van Allen Belts

A "slot-cutting mechanism" between the inner and outer Van Allen belts works to decrease the number of electrons in the area more rapidly than ordinary decay would account for. This was told to the American Physical Society by Walter L. Brown of the Bell Laboratories Semiconductor Research Dept. He said that immediately after the Russian high-altitude nuclear tests of Oct. 22 and 28, the gap or slot between the two Van Allen belts was nearly filled up with energetic electrons, the increase of electrons in the gap being greater than that in the belts themselves.

Before the tests, there were about 3 million electrons per centimeter per second on the magnetic field line crossing the equator at 4,500 miles altitude. After the second explosion, the number had increased to some 500 million electrons. When Telstar first went into orbit in July, shortly after the Starfish test, the flux of electrons at the peak of the Van Allen belt was even higher—about 800 million electrons per square centimeter per second. From that time to October, electron

intensity in the slot between the two belts showed a decay rate to the date of the Russian tests.

The nature of the mechanism that appears to be at work, cutting the slot between the two Van Allen belts, is still unknown—in fact, scientists do not know why there are two belts instead of a single broad one.

Nanosecond Photography With New Image Tube

A new image-converter tube, designed as a high-speed light shutter for special electronic cameras, greatly increases the speed at which multiframe photographs of extremely high-speed activity can be made. Exposures can be as short as one two-hundred-millionth of a second, according to C. E. Burnett, of the RCA Industrial Tube Products Dept. The new tube is used for such things as the study of lasers, exploding wires and gaseous charges.

The event or action is focused by a fast objective lens on the photocathode of the 10-inch-long, 4-inch-diameter tube. The light releases electrons from the photocathode, which are attracted toward the fluorescent screen at the opposite end of the tube. On their way, they go

through an electron gating grid, which can be charged either to stop the electrons coming from the cathode or to permit them to travel toward the screen. The grid also serves as a focusing electrode. The fine-grain, aluminum-backed screen can provide an increase in radiant energy of as much as 50 times the energy applied to the photocathode. Spectral response of the tube (RCA-4449) is from about 3,000 to 6,500 angstroms. The flat photocathode has a minimum useful diameter of 1.37 inches. Exposure times as short as 5 nanoseconds result in little loss in resolution. Minimum useful diameter of the screen is 3 inches.

TIROS Makes TV Pictures of Earth's Cloud Cover

TIROS—Television Infra-Red Observation Satellite—transmitted more than 203,000 TV pictures of the earth's cloud cover through the end of 1962, NASA discloses. The TIROS meteorological system was developed, tested and produced by RCA for NASA under the direction of Goddard Space Flight Center. Since April 1960, six TIROS satellites have been successfully launched and orbited in six tries. They have logged 1,157 days of useful life, reporting on ice floes, giving advance warning of hurricanes and other weather phenomena, and supplying data for intragovernmental use. Some have been used in launch support of deep-space probes like Mariner and Ranger. TIROS V and VI, still operating, are supplying operational weather data and serving as vehicles for further research.

The record shows, say RCA engineers, that TV space observations are feasible and that longevity in space is possible. NASA cites TIROS

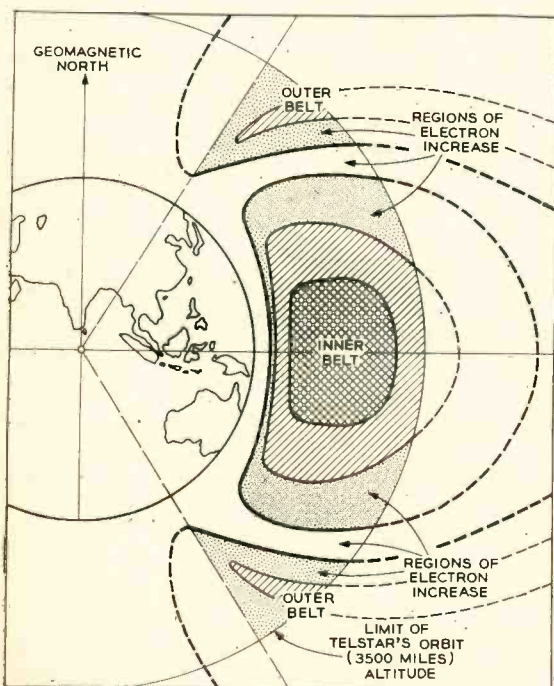

Increase in electron activity in the Van Allen belts is shown by the dotted area. (Only the regions actually traversed by Telstar are shaded.) The heavier shading indicates greater electron intensity inside the belts, and the crosshatched region is the area that had an electron flux of 800 million per square centimeter per second in July.

Advertising Representatives: South—J. Sidney Crane & Associates, 22 8th St. N.E., Atlanta, Ga., Tel. TRinty 2-6720. Florida: Neff Associates, 15 Castle Harbor Isle, Fort Lauderdale, Fla., Tel. LOgan 6-5656. West—Husted-Coughlin, Inc., 1830 W. 8th St., Los Angeles, Calif., Tel. 389-3132. 444 Market St., San Francisco, Calif., Tel. GARfield 1-0151. United Kingdom—Publishing & Distributing Co., Ltd., Mitre House, 177 Regent St., London, W.1, England. Subscription Service: Address form 3579 and correspondence to Radio-Electronics, Subscriber Service, 154 West 14th St., New York 11, N. Y. When requesting a change of address please furnish an address label from a recent issue. Allow one month for change of address.

3 More Big Training Advantages



DeVRY Tech Exclusive!

WITH TRANSISTORIZED METER . . . PLUS NEW "MODULAR CIRCUITS" TO BUILD AT HOME!

Now Prepare for **GOOD JOB OPPORTUNITIES IN ELECTRONICS** Faster — with

1. **METER** — Transistorized, Portable, AC-DC Multimeter
2. **SCOPE** — 5-inch New Streamlined Commercial-Type Oscilloscope
3. **ELECTRO-LAB*** — For 3-Dimension Circuit Building

To help you get ready **F-A-S-T-E-R . . .** and **THOROUGHLY . . .** for good-paying job opportunities in the fast growing Electronics field, DeVry Technical Institute now presents the newest and finest training advantages in its over 30 years of experience. Now . . . **AT HOME . . .** in your spare time, you prepare with "industry-type" home laboratory equipment. To provide real **PRACTICAL EXPERIENCE**, you build a quality Transistorized Meter and a 5-inch industrial-type Oscilloscope . . . work with small, 3-dimensional circuits on DeVry's new Design Console . . . use highly instructive home training movies . . . and follow up-to-date lessons with many time-saving fold-out diagram sheets.

Little wonder DeVry men qualify for such fine opportunities in Space-Missile Electronics, Automation, Computer Work, Radio-TV, Industrial Controls, and other fields.

You learn **PRACTICAL** techniques important in today's Space Age industry, because you build many **compact** circuits with the streamlined Electro-Lab, using **exclusive** solderless "modular connectors." You perform over 300 construction and test procedures in all! Your self-built test equipment has function-grouped controls, meter scales color-keyed to the panel markings—much like instruments used on today's jobs. What's so important, the home laboratory and the test equipment are **YOURS TO KEEP!**

INDUSTRY NEEDS TRAINED MEN

Through this remarkable 3-way method, DeVry Tech has helped thousands of ambitious men prepare for good jobs or their own profitable full-time or part-time service shops. It is the newest in a long series of **PRACTICAL** training aids that we have pioneered and developed in more than three decades of experience. Sound interesting? Then see how DeVry Tech may help **YOU**. Mail the coupon today.

From RADIO to SPACE-MISSILE ELECTRONICS

DeVry's training goes all the way from radio repair . . . to space-missile electronics. That's the range of subjects covered in its programs **AT HOME** or in its well-equipped training centers in Chicago and Toronto. You learn up-to-date techniques, working with new equipment, modern texts, movies—one of today's finest combinations of training equipment . . . geared for **RESULTS!**

EMPLOYMENT SERVICE

When you complete the program, DeVry's efficient Employment Service is ready to help you get started. There is no extra charge—ever—for this aid. **ACCREDITED MEMBER, NATIONAL HOME STUDY COUNCIL**

DeVRY TECHNICAL INSTITUTE
CHICAGO • TORONTO



OSCILLOSCOPE

DESIGN CONSOLE



METER

* Trademark ©

MAIL COUPON FOR FREE FACTS

DEVRY TECHNICAL INSTITUTE
4141 Belmont Ave., Chicago 41, Ill., Dept. RE-4-T

2082

Please give me your two free booklets, "Pocket Guide to Real Earnings" and "Electronics in Space Travel"; also include details on how to prepare for a career in Electronics. I am interested in the following opportunity fields (check one or more):

- | | |
|--|---|
| <input type="checkbox"/> Space & Missile Electronics | <input type="checkbox"/> Communications |
| <input type="checkbox"/> Television and Radio | <input type="checkbox"/> Computers |
| <input type="checkbox"/> Microwaves | <input type="checkbox"/> Broadcasting |
| <input type="checkbox"/> Radar | <input type="checkbox"/> Industrial Electronics |
| <input type="checkbox"/> Automation Electronics | |

Name _____ Age _____

Address _____ Apt. _____

City _____ Zone _____ State _____

- Check here if you face military service.
Canadian residents: Write DeVry Tech of Canada, Ltd.
970 Lawrence Avenue West, Toronto 19, Ontario



ROHN

The most Famous Name in
TOWERS of ALL KINDS!

Here are the advantages you get
when you insist on **ROHN TOWERS**

LARGEST FULL RANGE OF TOWERS—you can get anything from home TV and amateur radio towers to heavy-duty communication and micro-wave towers. Included are 170 foot self-supporting towers, 1,000 foot guyed towers, and "fold-over" towers. Regardless of your needs, ROHN can supply it.

UNQUESTIONED LEADERSHIP IN DESIGN AND MANUFACTURE—you get the latest in advanced tower engineering. All communication towers are engineered to EIA specifications, and are proved by thousands of installations. No other manufacturer can surpass the quality and fine reputation of ROHN.

QUALITY MATERIALS AND WORKMANSHIP—Only highest quality steel is used which fully meets the specifications for the job. ROHN towers are hot-dipped galvanized after fabrication—a feature ROHN pioneered!

SERVICE WHEREVER YOU WANT IT—ROHN representatives are world-wide. Complete erection service for communication systems, broadcasting, micro-wave, and other needs is available; also competent engineering service to help you.

Settle for the BEST in TOWERS—ROHN—today the world's largest, exclusive manufacturer of towers of all kinds!

For your needs, contact your local ROHN salesman, distributor or dealer; or write direct for information.



SEND THE HANDY COUPON INDICATING YOUR NEEDS

ROHN
Manufacturing
Company
BOX 2000
PEORIA, ILLINOIS

ROHN Manufacturing Company
Box 2000
Peoria, Illinois

Send me complete literature on the following ROHN Products:

- | | |
|---|--|
| <input type="checkbox"/> Home TV Towers | <input type="checkbox"/> Amateur Towers |
| <input type="checkbox"/> Communication Towers | <input type="checkbox"/> AM-FM Broadcasting Towers |
| <input type="checkbox"/> Micro-Wave Towers | <input type="checkbox"/> Government |

Name _____

Firm _____

Address _____

City _____

State _____

COMING

IN
THE
MAY
ISSUE
OF
RADIO-
ELECTRONICS

Build an All-Transistor Hi-Fi Amplifier — 10 watts with 8 transistors.

What Is a Dry Cell? — A battery engineer tells about modern mercury, carbon-zinc and alkaline batteries.

Handling the Color TV Customer — The customer can be the critical component in a color TV installation.

More Power Into Your Citizens Band Antenna — Get maximum reliability by using the right antenna and using it right.

MAY ISSUE on Sale
April 23



Storm vortex is shown in this TV picture taken by TIROS V on Dec. 5, 1962. A dangerous formation is shown, with an unusual swirling mass of clouds.

as an example of the use of space for peaceful purposes.

Now—The X-Ray Vidicon

A vidicon camera tube that can be used to detect flaws inside 1/8-inch-thick metal casings is now being sold by the Machlett Laboratories, Inc., an affiliate of Raytheon. How it can be used to check electronic parts is shown in the photos. The open circuit in the diode appears very clearly. The new tube is also extremely useful in medical studies, as well as in some nondestructive testing applications.

The new tube, labeled ML-589, uses an X-ray-sensitive layer as its sensor element, instead of the light-sensitive, photoconductive layer of ordinary vidicons. Interchangeable with standard vidicons, it is 1 inch in diameter and 6 inches long. It requires

(Continued on page 12)

CALENDAR OF EVENTS

Electronics Industries Assoc. Spring Conference, Mar. 20-22; Statler Hilton Hotel, Washington, D.C.

1963 IEEE Convention, Mar. 25-28: Waldorf-Astoria Hotel and Coliseum, New York.

SSB Amateur Radio Association 12th Annual SSB Dinner and Hamfest, Mar. 26: Hotel Statler Hilton, New York.

High Fidelity Music Show, Institute of High Fidelity, Apr. 2-7: Ambassador Hotel Cottages, Los Angeles, Calif.

Symposium on Optical Masers, sponsored by IEEE, Optical Society of America and U.S. Defense Research Agencies, Apr. 16-18; Waldorf-Astoria Hotel, New York.

Convention of the British Institution of Radio Engineers, Apr. 16-20; University of Southampton, England.

Southwestern IRE Conference and Electronics Show (SWIRECO), Apr. 17-19; Dallas, Tex.

SMPTA Convention, Apr. 21-26 (exhibits Apr. 22-25); Traymore Hotel, Atlantic City, N.J.

Electronic Components Conference (IEEE sponsored), May 7-9; International Inn, Washington, D.C.

1963 National Telemetering Conference, May 20-22; Hilton Hotel, Albuquerque, N.M.

Electronic Parts Distributors Show, May 20-22; Conrad Hilton Hotel, Chicago. RADIO-ELECTRONICS and GERNSBACK LIBRARY will be in Booth 4501, West Hall, and Rm. 655.

Third International Television Symposium, May 20-24; Montreux, Switzerland.

What Job Do You Want In Electronics?

Whatever it is, Cleveland Institute can help you get it!

Yes, whatever your goal is in Electronics, there's a Cleveland Institute program to help you reach it *quickly* and *economically*. Here's how: Each CIE program concentrates on electronics theory as applied to the solution of practical, everyday problems. Result . . . as a Cleveland Institute student you will not only learn electronics but *develop the ability to*

use it! This ability makes you eligible for any of the thousands of challenging, high-paying jobs in Electronics. Before you turn this page, select a program to suit your career objective. Then, mark your selection on the coupon below and mail it to us *today*. We will send you the complete details . . . without obligation . . . if you will act NOW!

Electronics Technology



A comprehensive program covering Automation, Communications, Computers, Industrial Controls, Television, Transistors, and preparation for a 1st Class FCC License.

First Class FCC License



If you want a 1st Class FCC ticket quickly, this streamlined program will do the trick and enable you to maintain and service all types of transmitting equipment.

Industrial Electronics & Automation

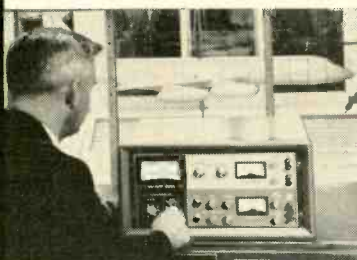

This exciting program includes many important subjects as Computers, Electronic Heating and Welding, Industrial Controls, Servomechanisms, and Solid State Devices.

Electronic Communications



Mobile Radio, Microwave, and 2nd Class FCC preparation are just a few of the topics covered in this "compact" program . . . Carrier Telephony too, if you so desire.

Broadcast Engineering



Here's an excellent studio engineering program which will get you a 1st Class FCC License and teach you all about Program Transmission and Broadcast Transmitters.

Mail Coupon TODAY For FREE Catalog

Cleveland Institute of Electronics

1776 E. 17th St., Dept. RE-78
Cleveland 14, Ohio

Please send FREE Career Information prepared to help me get ahead in Electronics, without further obligation.

CHECK AREA OF MOST INTEREST—

- | | |
|---|--|
| <input type="checkbox"/> Electronics Technology | <input type="checkbox"/> First Class FCC License |
| <input type="checkbox"/> Industrial Electronics | <input type="checkbox"/> Electronic Communications |
| <input type="checkbox"/> Broadcast Engineering | <input type="checkbox"/> _____ other |

Your present occupation _____

Name _____ Age _____
(please print)

Address _____

City _____ Zone _____ State _____

Approved for Veteran's Training under Korean GI Bill. RE-78

Cleveland Institute of Electronics

1776 E. 17th St., Dept. RE-78
Cleveland 14, Ohio



Accredited Member

The Star-Spangled Banner

Francis Scott Key

John Stafford Smith

With spirit
O say! can you see, by the dawn's ear-ly

Piano

light, What so proud-ly we hail'd at the twi-light's last

glean-ing? Whose broad stripes and bright stars, thro' the per-il-ous



Two things you're sure to hear at a public event

Wherever people gather, wherever words and music must be heard with perfect fidelity, you're sure to hear University...largest selling P.A. loudspeakers in the world.

University is Public Address. The reasons can be summed up in two words, **high audibility**—"High A", that special engineering factor built into University P.A. speakers to give them an extra degree of intelligibility, a clean, crisp, sound no other P.A. speakers can match. You hear the proof at political rallies and conventions, in the great

churches, stadiums and arenas, in hospitals, factories, missile bases—everywhere from Presidential inaugurations to Little League play-offs.

You can't lose a P.A. customer when you have the superiority of over 62 different University speaker products in every price range behind you. Write Desk 'J-4 for our latest P.A. catalog:

**UNIVERSITY
LOUDSPEAKERS**
80 SOUTH KENSICO AVE., WHITE PLAINS, N.Y.
A Division of Ling-Temco-Vought, Inc.

DID YOU EARN \$6,000.00 TO \$8,000.00 LAST YEAR?

THESE MEN DID—AFTER COMPLETING GRANTHAM TRAINING

Here, in a nutshell, are their success stories:

“I was a grocery clerk . . .”

(Max D. Reece, Seattle, Washington)

He says: “Before I took the course, I was a grocery clerk.” He states that the Grantham course enabled him to gain employment in electronics. (His salary is now over \$6,000.00 a year.)

“money saved . . .”

(David R. Karn, Spokane, Washington)

He says: “I worked for Boeing and Lockheed . . . due to Grantham training. With the money I saved from electronics employment, I am now able to attend college.” He says the course was “invaluable” in deciding his career.

“test given by employer . . .”

(Douglas E. Evers, Seattle, Washington)

He says that Grantham training “. . . helped greatly in obtaining a high score on the test given by my employer.” (Employed in electronics by a large airplane manufacturer. Salary: \$7,000.00 a year.)

“would not have been hired . . .”

(Robert F. Henke, Carnegie, Penna.)

He says: “Without Grantham training, I would not have been hired. My job is more satisfying, interesting, and pays much more.” (He is engineer at Radio Station KQV. Salary: Over \$7,000.00.)

“able to move in . . .”

(E. W. Hale, Arlington, Virginia)

He says: “Was able to move into this job after having Grantham training.” (Now employed by a large airline at over \$7,000.00 a year. He maintains radio equipment.)

“amazed . . .”

(Douglas S. Atkins, Las Vegas, Nevada)

He says: “I was amazed . . .” at how complete the course is. He credits Grantham with preparing him for his last two promotions. (Earns \$6,500.00 plus \$3,500.00 in bonus and overtime.)

“wages tripled . . .”

V. Godoshian, Pontiac, Michigan)

He says: “My wages have tripled (since completing the course) . . .” What influence did the course have? “My job depended on it.” (He is employed at a radio station. His salary: Over \$7,000.00 a year.)

“a classmate told me . . .”

(Antone J. Mello, Grand Rapids, Mich.)

He says that a classmate told him about the opening that led to his present job. (Employed by radio-TV station. Salary: Over \$8,000.00 a year. Says GSE training got him his job.)

“by far the best . . .”

(Michael J. Mitchell, Seattle, Washington)

He says: “Your course did help me . . . it is by far the best in its field.” (He earns \$6,800.00 plus overtime. Also, his part-time electronics company nets him an additional \$1,500.00.)

What about other Grantham graduates?

Many others, like these men, have greatly improved their positions after getting their first class F.C.C. licenses through Grantham training. Frequently, these men write to us or drop in at one of our schools to let us know how much the training and the license means to them. And, if we don't hear from them before very long, we write them, to learn what they have been doing since graduating from our school.

As a matter of fact, it wasn't very long ago that we sent out a questionnaire form to a number of our graduates. We wish you could see their replies. Actually, in

many cases, these men plainly stated that they could not have advanced so rapidly in their jobs, in both prestige and in salary, if they had not taken our course of training. And, as we expected, this survey proved that the turning point in a man's career often comes when he obtains his first class F.C.C. license.

We are encouraged by their successes. There is no better proof, we feel, that the Grantham course can do big things for others. It can do big things for you. Why not look into it? We invite your inquiry. Use the coupon below and we will send you our brochure by return mail.

A Word About the Course of Instruction:

When you receive our brochure, you will see that Grantham offers both home study instruction and resident (classroom) instruction. You will see how these training programs are conducted, the length of time necessary for completion of the course, and all other pertinent information.

The brochure will tell you, for example, that the resident course can be completed in just 12 weeks. It will tell you how you can estimate the length of time necessary for completion of the home study course. And, it will tell you that Grantham School is an accredited member of the National Home Study Council.

GRANTHAM SCHOOL OF ELECTRONICS

1505 N. Western Ave.
Hollywood 27, Calif.
(HO 7-7727)

408 Marion Street
Seattle 4, Wash.
(MA 2-7227)

3123 Gillham Road
Kansas City 9, Mo.
(JE 1-6320)

821-19th Street, NW
Washington 6, D. C.
(ST 3-3614)

(Mail coupon for complete details)

To: GRANTHAM SCHOOL OF ELECTRONICS
NATIONAL HEADQUARTERS OFFICE
1505 N. Western Ave., Hollywood 27, Calif.



Upon receipt of this coupon, the School will send complete details by return mail. There is no obligation, and no salesman will call. (Please indicate the division of the School in which you are interested.) Hollywood classes, Seattle classes, Kansas City classes, Washington classes, Home Study.

Name _____ Age _____

(PLEASE PRINT)

Address _____

City _____

State _____

34-D

Pack up your troubles



and send them to CASTLE

Ask yourself

... do you have the time to fool around drilling, sawing, filing ... trying to make a "Universal" replacement tuner fit in place of the original? Do you have all the expensive instruments and equipment to complete the alignment so essential after each tuner repair or replacement? Can you spare the time repairing and adjusting your own TV tuners and can you charge enough to justify the time spent?

A Castle Overhaul eliminates every one of these problems.

Castle replaces all defective parts (tubes and major parts are extra at net prices) and then aligns your tuner to the exact, original specifications. Simply send us your defective tuner complete; include tubes, shield cover and any damaged parts with model number and complaint.

ALL MAKES ONE PRICE

VHF TUNERS
UHF TUNERS
UV COMBINATIONS*



9.95

*UV combination tuner must be of one piece construction. Separate UHF and VHF tuner with cord or gear drives must be dismantled and the defective unit sent in. 90 Day Warranty.

Send for FREE Mailing Kit and complete details

CASTLE
TV TUNER SERVICE, INC.

Check Map for the
Castle Center Serving You.



5715 N. WESTERN AVE., CHICAGO 45, ILLINOIS
653 PALISADE BLVD., CLIFFSIDE PARK, N. J.
CANADA: 136 MAIN ST., TORONTO 13, ONTARIO

Pioneers in  TV Tuner Overhauling

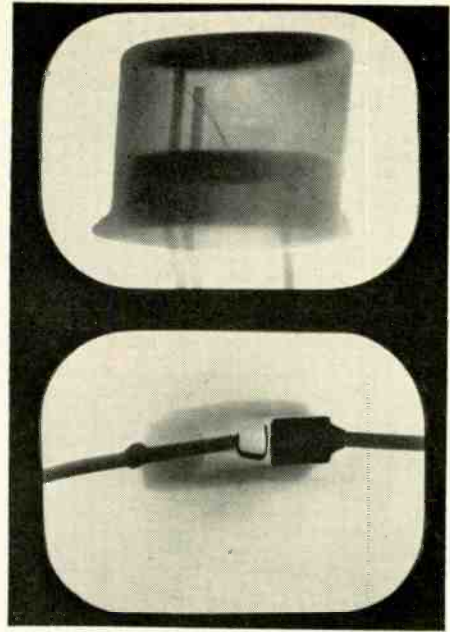

(Continued from page 8)

an adequate source of X-ray "light". The detailed resolution is comparable to that of fine-grade, high-contrast radiographic film, making the tube suitable for high-resolution applications and magnification up to 50X.

MHD Generator Uses Superconductive Materials

Practical use of *magneto*hydrodynamic (MHD) electric power generation was brought closer by a new generator which uses a superconducting magnet, say scientists of the Westinghouse Research Laboratory. Magneto hydrodynamic generation is the production of electricity by passing a stream of white-hot gas through the field of a strong magnet.

The magnet has to be so strong that until now it required practically all the output of the generator to

power it. Using a superconducting magnet, which needs almost no electric power whatever to produce a field far stronger than that of the electromagnets ordinarily used, reduces costs tremendously and eliminates tons of weight from even a small experimental machine.

The production of a superconducting magnet with its magnetic field in air outside the bath of liquid helium—only 7° above absolute zero—was announced as a scientific triumph by Westinghouse only a month previous. Now, only an inch away from the liquid helium bath at this fantastically low temperature, the hot gases of the generator stream through the magnet's field at 4,500°F higher than the boiling point of aluminum or copper.

New Device Combines Tube and Transistor Features

RCA has announced the development of a "revolutionary solid-state element, combining the best properties of transistors and vacuum tubes." Called a metal oxide semiconductor transistor, it is described as an "insulated-gate, field-effect transistor, made of silicon and capable of amplifying electric voltages," by Dr. William M. Webster, director of RCA Laboratories electronic research program. "By varying the input voltage on the insulated gate," said Dr. Webster, "the device as a whole can be made to switch, amplify or otherwise regulate its output of electric current in a manner analogous to a pentode vacuum tube." In conventional transistors, he explained, similar results are achieved by varying the input current. While voltage-control led transistors are not new in principle, Dr. Webster ex-

The new Westinghouse superconducting MHD generator.

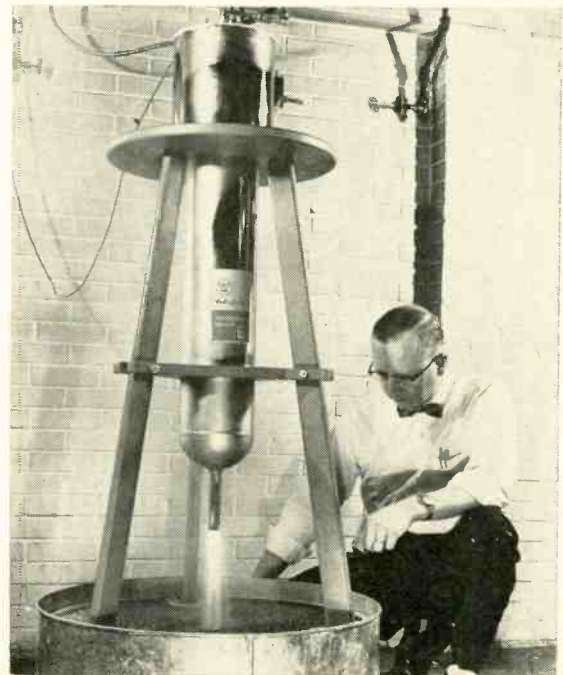

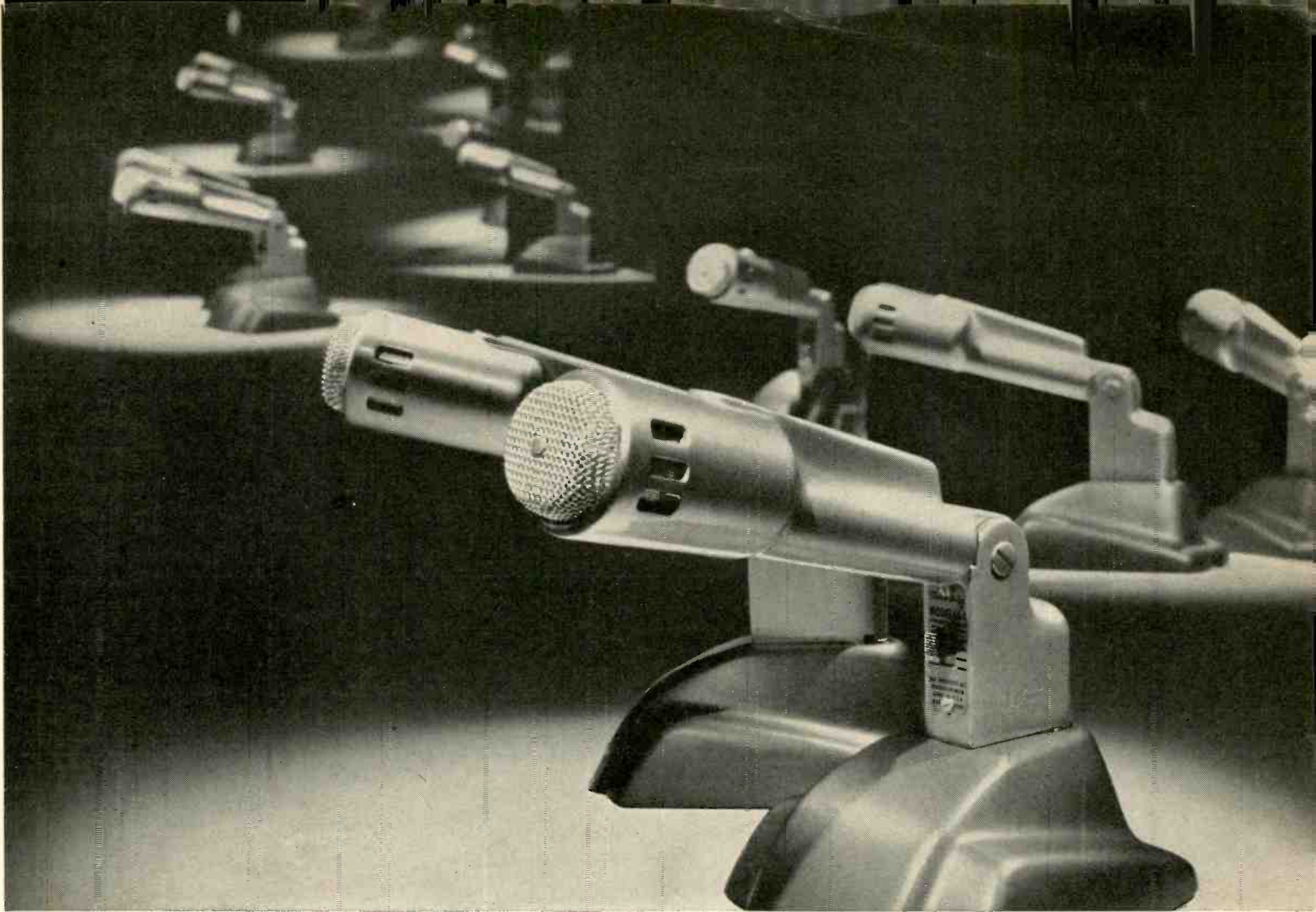

E-V matched dynamic microphones take guesswork out of stereo recording

*Now, whether you buy
E-V microphones singly,
or in pairs... E-V uniform
quality assures custom-
matched performance
for stereo recording.*

For living, vibrant stereo reproduction of words and music, dynamically matched microphones are the vital key to fidelity. Electro-Voice custom matching means microphones are specifically engineered to equal each other in frequency response, polar pattern and overall sensitivity. These characteristics take the guesswork out of stereo recording — make microphone placement easier, give more uniform recording quality, offer better stereo separation, create natural sound reproduction, yield professional results and reduce “trial and error” time. Not only are they matched but their smooth response, wide range, high sensitivity, ruggedness and reliability are the same basic features which have made E-V professional microphones the choice of critical recording studios, radio and television networks and leading independent stations. There is no finer choice than Electro-Voice . . . no finer microphone buy for the money.



Model 664
Dynamic Cardioid
“Best for Noise Control”
List \$85.00 each

Model 636
Dynamic Nondirectional
“Widest Range . . . Slim Style”
List \$72.50 each



Model 623
Dynamic Nondirectional
“Modern Design . . .
Budget Priced”
List \$57.00



Model 630
Dynamic Nondirectional
“Rugged . . . Reliable”
List \$52.50 each

*Write for your FREE
E-V microphone catalog.
Over 50 models to choose
from for stereo recording
and every other sound need.*

THE SPEAKER THAT SELLS ITSELF

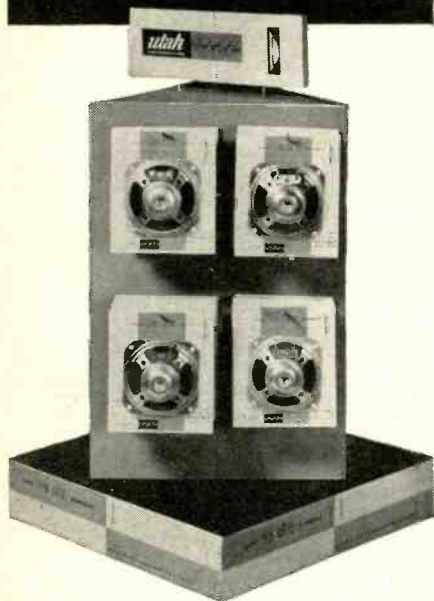

New Utah Thin-Drive Speakers in self service bubble pack display

Utah's radically new Thin-Drive Speaker is available in all popular sizes. It uses a completely new magnetic material (Lodex by G.E.). The "pot" is reduced in size and weight—efficiency and performance increased. The Thin-Drive is thinner in profile, allowing more knuckle room in tightly packed sets.

A beautiful combination!

Utah's new Thin-Drive speakers come individually carded—sealed in clear plastic bubbles for optimum protection and display.

Utah's attractive self service display rack offers fingertip convenience, self-merchandising—self-pricing. See your Utah distributor.



plained, their great promise has gone largely unrealized because of high production costs, technological difficulties, and the early popularity of current-controlled transistors.

The new device will be especially applicable to integrated circuitry. (Arrays of up to 850 of them have been produced in an area the size of a dime.) Integrated circuitry with these components may make portable, battery-operated, high-speed computers possible, as well as a host of applications in communications systems, military and industrial equipment of small size, operating over wide temperature ranges, with great resistance to nuclear radiation.

Voice of America Doubles Its Power

The world's largest and most powerful short-wave radio station went on the air Feb. 8, when US Information Agency's Voice of America opened its new facilities at Greenville, N.C. USIA Director Edward R. Murrow gave the inaugural address.

With a total output of 4,800,000 watts, equal to the power of 96 top-strength commercial stations, the Greenville facilities double VOA's power. Marked by a forest of antennas, some as high as 400 feet, the 6,000-acre plant includes one receiver site and two transmitter locations. Construction took 3 years and cost \$23 million.

The new plant enables VOA to broadcast more clearly to Latin America, Europe and Africa, and will support new stations planned for the future in five areas. It is considered the most important single component in a program to strengthen the Voice of America, letting it compete more effectively with Radio Moscow and Radio Peking.

MPATI Asks More Channels

The Midwest Program for Airborne Television Instruction has asked for six permanent uhf channels, proposing to transform the project from its present experimental basis to a regular operation broadcasting 180 hours per week. The program has been operating for a year and a half, with two separate programs—on channels 72 and 76—transmitted simultaneously from a plane flying over Montpelier, Ind., and sending lessons received in six states, over an area holding more than 7 million students. The proposed six-channel system will make more efficient coverage possible and lower the cost per student hour.

First TV Transmission Over Laser Beam

The first transmission of television on a microwave-modulated laser beam was demonstrated Feb. 20 at the General Telephone & Electronics Laboratories, Bayside, N. Y.

Two new developments made the breakthrough possible. The first: an electro-optic modulator, a metallic cylinder not more than about 2 inches in diameter and 2 inches long, with holes in the ends and a small potassium dihydrogen phosphate (KDP) crystal at its center. The second is a microwave photodetector developed by the Microwave Devices Div. of Sylvania.

In the demonstration, the video signal from an ordinary TV receiver was fed to a traveling-wave tube that was being driven at the same time at 3,000 megacycles by a klystron oscillator. The TV-modulated 3,000-mc signal was amplified and applied through a waveguide to the modulator, which is a resonant cavity at 3,000 mc. The beam from a gas laser passed through the holes in the ends of the cavity and through the crystal at its center, emerging from the cavity as an intensity-modulated optical carrier containing the microwave signal and the television information that was impressed on it.

The laser beam was then directed onto the photodetector, a special type of traveling-wave guide with a photosensitive cathode. The laser light striking the cathode produced an electron beam containing the microwave subcarrier and the video information. The tube's output was further amplified and fed to a video detector, thence to a TV monitor for display.

It was pointed out by Dr. Lee L. Davenport, president of GT & E, that the system was probably several years from practical application, but that the ultimate possibilities were fantastic. More than 160 TV channels or 100,000 telephone channels could be carried on a single laser beam, he said, as compared with 10 TV channels or 6,000 simultaneous telephone conversations possible with the best microwave systems of today.

English Slant on Educational TV

Charley Bayley, 80, of Blackpool, England, credits television with helping him get an education. "I got so sick of the programs," he said, "that one night I shut the thing down and signed up at a night school." That happened 5 years ago, and now he has certificates of proficiency in English, French, mathematics and Latin. END

To assure **ADVANCEMENT** or to turn your hobby into a new and **PROFITABLE CAREER** in the fast growing field of **ELECTRONICS**

you should investigate the **NRI Home-Study Courses in Industrial Electronics, Radio-TV Servicing, Radio-TV Communications**

Qualify for Higher Pay

You must be *trained* to qualify for higher earnings and advancement. Whichever branch of Electronics you select, you'll find that NRI training is the time-proved way to get into this interesting and fast growing industry.



Training Equipment Included

When you learn Electronics through NRI you use scientifically developed "learn-by-practice" methods. At no extra cost, NRI sends special equipment that gives actual experience, makes theory you learn come to life in an easy-to-grasp, interesting manner. You perform a wide variety of experiments working with basic circuits and components. All equipment is yours to keep.



Oldest and Largest School

For nearly half a century, NRI has featured Electronics training, progressing from Radio and Television servicing and communications to Industrial and Military Electronics. As the oldest and largest home-study school of its kind, NRI can supply training at reasonable cost. Monthly payment plans. Take the first step toward a successful career now. Mail postage-free card. Get NRI CATALOG without cost or obligation. **National Radio Institute, Washington 16, D.C.**

There is an immediate and growing need for trained Technicians in many branches of Electronics. In fact, four to seven trained Technicians are needed for every graduate engineer. Better than average jobs await you in the fast growing industry of the 1960's . . . offering high pay and prestige, interesting work and a bright future. Join the thousands of NRI graduates who have benefited from career opportunities in this Electronic Age. Mail the postage-free card today.

Turn Page for Facts on NRI Courses ▶

Cut Out and Mail—No Stamp Needed



NATIONAL RADIO INSTITUTE
Washington 16, D. C. RE

Please send me your Electronic, Radio-TV catalog without cost or obligation. I am interested in course checked below. (No salesman will call. PLEASE PRINT.)

- | | |
|--|--|
| <input type="checkbox"/> Industrial Electronics | <input type="checkbox"/> FCC License |
| <input type="checkbox"/> Radio-TV Servicing | <input type="checkbox"/> Mobile Communications |
| <input type="checkbox"/> Math for Electronics | <input type="checkbox"/> Aircraft Communications |
| <input type="checkbox"/> Communications (Complete) | <input type="checkbox"/> Marine Communications |

Name _____ Age _____

Address _____

City _____ Zone _____ State _____

ACCREDITED MEMBER NATIONAL HOME STUDY COUNCIL

Approved for Veteran's under Korean GI Bill

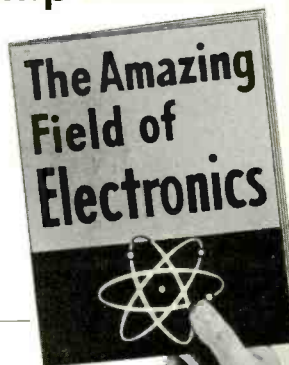

PICK THE CAREER YOU WANT IN THE WONDERFUL FIELD OF ELECTRONICS TRAIN AT HOME WITH THE LEADER

INDUSTRIAL ELECTRONICS



Prepare for a career as an Electronic Technician in industry, business, government, the military, with this NRI course in Electronics—Principles, Practices, Maintenance. Computers, telemetry, automation, missiles, rockets all employ the same basic principles . . . and that is what this NRI course stresses with illustrated lessons, special training equipment.

TELEVISION-RADIO SERVICING (INCLUDES COLOR TV)

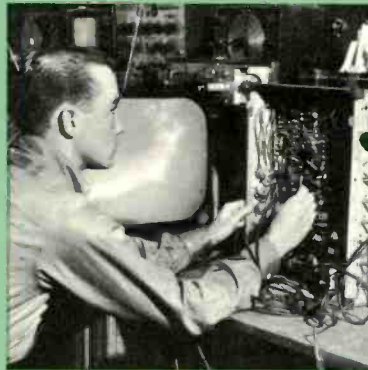

NRI's time-tested course in Servicing not only trains you to fix radios, TV sets, hi-fi, etc., but also shows you how to earn spare-time money starting soon after enrolling. Fast growth in number of sets, color-TV, stereo, means money-making opportunities in your own spare-time or full-time business or working for someone else. Special training equipment included.

TV-RADIO COMMUNICATIONS



In the NRI Communications course you get *actual experience* as NRI prepares you for your choice of Communications fields and an FCC License. Commercial methods and techniques of Radio and TV Broadcasting; teletype; facsimile; microwave; radar; mobile and marine radio; navigation devices; FM stereo multiplexing are some of the subjects covered. You work with special training equipment.

FCC COMMERCIAL LICENSE



For men with Radio-TV experience who want to operate or service transmitting equipment used in broadcasting, aviation, marine, microwave, facsimile or mobile communications. A Service Technician is *required by law* to have an FCC License to work on C-Band, other transmitting equipment. From Simple Circuits to Broadcast Operation, this new NRI course trains you quickly for your Government FCC examinations.

← SEE OTHER SIDE →

FIRST CLASS
PERMIT
NO. 20-R
(Sec. 34.9, P.L.&R.)
Washington, D.C.

BUSINESS REPLY MAIL
NO POSTAGE STAMP NECESSARY IF MAILED IN THE UNITED STATES

POSTAGE WILL BE PAID BY

NRI  **National Radio Institute**
3939 Wisconsin Avenue
Washington 16, D.C.

ALSO: Special courses in Mobile Communications; Aircraft Communications and Guidance; Marine Communications; Math for Electronics.

Today, a career in Electronics offers unlimited opportunity. Job counselors advise, "For an interesting career, get into Electronics." The National Association of Manufacturers says, "There is no more interesting and challenging occupation in American industry."

When you train for a career in Electronics through NRI home-study methods your home becomes your classroom, and you the only student. You pick your own study hours, study when you want, as long as you want. No need to give up your job or go away to school. And there are no special requirements of previous Electronics experience or education. Train with the leader. Your NRI training is backed by nearly 50 years of success. Mail the postage-free card. National Radio Institute, Washington 16, D.C.

← MAIL POSTAGE-FREE CARD NOW

Correspondence



This is a Shortage?

Dear Editor:

Re "Technician Shortage Worsens," page 66, February 1963:

I am a graduate of the Electronic Training Center of Allentown, Pennsylvania, having completed a one-year course in radio-TV-electronics that included a smattering of color TV. I have enrolled in Capital Radio Engineering Institute's extension course (units 1-6).

The article interested me and my fellow students for we have found employment in our chosen field to be very scarce indeed. The last time a firm sent recruiters to ETC was over 15 months ago. I have registered with three employment agencies, but no luck yet. I have six years of military experience, 25 weeks training in Carrier, a year of college, and the year of technical school.

Where is the employment?

Philadelphia papers show dozens of \$100-a-week-to-start ads, but when I follow them up they turn out to be come-ons, and what they really want is a man who will commute 100 miles a day for \$45 a week, to replace someone who asked for a raise. The Western Electric plant here has 3,000 applicants and no openings. Local TV dealers fish for crack benchmen and offer \$50 a week. Several acquaintances have given up and found work in other fields.

This is a shortage?

RODNEY D. SQUIRES

Allentown, Pa.

No Shortage in R.I.

Dear Editor:

This letter pertains to your article "Technician Shortage Worsens" in the February 1963 issue of RADIO-ELECTRONICS (page 66).

I am a graduate of a two-year school. I have an FCC first-class radio-telephone license with radar endorsement. When I graduated in September 1961 I was called up during the Berlin crisis (October). With the 107th Signal Co. I received good military experience in operating and repairing radio relays. Since August 1962, when I was released, I have not been working. It's been six long months, and I am not

CHECKS AND REJUVENATES ALL PICTURE TUBES
WITHOUT ADAPTORS OR ACCIDENTAL TUBE DAMAGE



\$69⁹⁵

the all NEW

Featuring Automatic
Controlled
Rejuvenation

SENCORE

CR125 CATHODE RAY TUBE TESTER

From SENCORE, designers of the famous Mighty Mite Tube Tester and other valuable time savers, comes another industry best. An all new method of testing and rejuvenating picture tubes. Although the method is new, the tests performed are standard, correlating directly with set-up information from the RCA and GE manuals.

Check these outstanding features and you will see why this money making instrument belongs on top of your purchasing list for both monochrome and color TV testing.

Checks all picture tubes thoroughly and carefully; checks for inter-element shorts, cathode emission, control grid cut-off capabilities, gas, and life test.

Automatic controlled rejuvenation. A Sencore first, preventing the operator from over-rejuvenating or damaging a tube. An RC timing circuit controls the rejuvenation time thus applying just the right amount of voltage for a regulated interval. With the flick of a switch, the RC timer converts to a capacity type welder for welding open cathodes. New rejuvenation or welding voltage can be re-applied only when the rejuvenate button is released and depressed again.

Uses DC on all tests. Unlike other CRT testers that use straight AC, the CR125 uses well filtered DC on all tests. This enables Sencore to use standard recommended checks and to provide a more accurate check on control grid capabilities. This is very important in color.

No interpretation chart. Two "easy view" neon lights clearly indicate shorts between any element. A chart is included for interpretation of shorts, if desirable. This chart is not necessary for normal testing on the CR125.

No adaptor sockets. One neat test cable with all six sockets for testing any CRT. No messy adaptors, reference charts or up-dating is required. The Sencore CR125 is the only tester with both color sockets. (Some have no color sockets, others have only the older type color socket.)

No draggy leads. A neat, oversized compartment, in the lower portion of the CR125 allows you to neatly "tuck away" the cable and line cord after each check in the home.



All six sockets, including latest color socket, on one neat cable.

SENCORE, INC.

426 S. WESTGATE DRIVE
ADDISON, ILLINOIS

SPECIAL INTRODUCTORY OFFER WORTH \$5.00

Most SENCORE products are sold by recommendation. So that you will be first in your area to buy and recommend the CR125, this coupon is worth \$5.00 on the purchase of the CR125 when presented to your parts distributor.

Why not save \$5.00 now?

Herb Bowden
President

over 100,000,000
already sold!



MINIATURIZED

ELMENCO

Dipped Mylar* Paper Capacitors

first choice with service technicians!

Now being used in millions of television sets, radios, phonographs, electronic circuitry and military applications. ■ Operates at 125° C without derating. ■ Standard Tolerance ±10% ■ Missile Reliability ■ Completely moisture proof ■ Up to 50% smaller than other types.

NOW AT NEW LOW PRICES

DON'T ACCEPT SUBSTITUTES OR IMITATIONS!

Available at all reputable ARCO distributors in U.S.A.

ARCO
electronics inc.

Community Drive
Great Neck, New York
Branches:
Dallas 7, Los Angeles 35



alone. There is nothing in Rhode Island and most of Massachusetts—I've tried every company within a 50-mile radius. The state employment office tells me I have to move, there is nothing here, but I can't—my father is disabled.

If you know of any companies looking for electronic technicians, please send them to R.I. We technicians are dying here.

JAMES DERDERIAN

Providence, R.I.

Deadly Chicken House?

Dear Editor:

In "What's your EQ?", February 1963 (page 47), I found two errors.

1. In the questions, spst switches were called for, but in the answer you used spdt switches.

2. The Electrical Code states that the neutral wire should not be switched unless the hot wire is opened at the

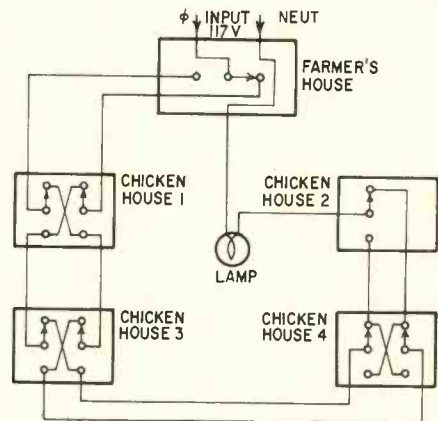

same time. Also, the lamp shell must be connected to the neutral. Neither condition is met in the answer.

The corrected diagram shows a hookup used often in wiring three-way and four-way switches.

NORMAN L. CURL

Basking Ridge, N.J.

Snug Motor is Real Answer

Dear Editor:

I note that in the Correspondence section of the February 1963 issue (p. 21), that at least two readers spotted the needless complication of the "Start Your Car Fast" article in the December 1962 issue. I had every intention of writing something like "Why do it the hard way?"

Mr. Paul L. Esmay's letter proposing an spdt relay to switch the ignition to the auxiliary battery is what I was going to propose except I would provide a separate pair of contacts to return the auxiliary battery to the main battery so that it can be kept charged.

Unfortunately, there is more to starting a cold motor than merely providing a hot spark. Liquid fuel lies in the intake manifold and fails to vaporize effectively. Crankcase oil turns to

RADIO-ELECTRONICS



IN THE MISSILE PROGRAM at Vandenberg Air Force Base is CREI graduate Robert N. Welch. Moving ahead rapidly since enrolling with CREI, he is now a Philco TechPep Engineer and section leader in the Precision Measurement Equipment Laboratory

If you are employed in electronics



WE WANT TO SEND YOU THE FREE BOOK that started this man on the way to a rewarding career

Today Robert N. Welch has a well-paying, exciting position in space age electronics. But he held a routine job when he sent for our free book, "Your Career in Electronics and Nuclear Engineering Technology".

From this 58-page book, he discovered the real reason why some men move ahead in electronics while others stand still. He learned the vital importance of advanced knowledge of electronics to a man who cannot be satisfied with an uninteresting, low-paying job. He found out why CREI Home Study Programs are recognized by leading organizations as particularly effective preparation for a career in advanced electronics. Mr. Welch is just one of thousands of men in every phase of electronics who profited from reading this book. Send for free copy. Use coupon or write: The Capitol Radio Engineering Institute, Dept. 1404A, 3224 16th St., N.W., Wash. 10, D. C.

	CREI <i>Founded 1927</i>
	Accredited Member of the National Home Study Council The Capitol Radio Engineering Institute Dept. 1404A, 3224 Sixteenth St., N.W. Washington 10, D.C.
Please send me FREE book describing career opportunities and CREI Programs in advanced electronics. I am employed in electronics and have a high school education.	
Name _____	Age _____
Address _____	
City _____	Zone _____ State _____
Employed by _____	
Type of Present Work _____	
Check: <input type="checkbox"/> Home Study <input type="checkbox"/> Residence School <input type="checkbox"/> G. I. Bill	
43	

Tarzian offers
**FAST, DEPENDABLE
TUNER REPAIR
SERVICE (ALL MAKES)**

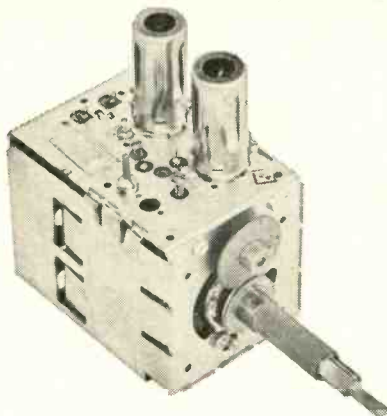

It just makes sense that a manufacturer of tuners should be better-qualified, better-equipped to offer the most dependable tuner repair and overhaul service.

Sarkes Tarzian, Inc. pioneer in the tuner business, maintains two complete, well-equipped Factory Service Centers—assisted by Engineering personnel—and staffed by specialized technicians who handle **ONLY** tuner repairs on **ALL** makes and models.

Tarzian-made tuners received one day will be repaired and shipped out the next. Allow a little more time for service on other than Tarzian-made tuners.

Tarzian offers a 12-month guarantee against defective workmanship and parts failure due to normal usage. And, compare our cost of \$9.50 and \$15 for UV combinations. There is absolutely no additional, hidden charge, for **ANY** parts except tubes. You pay shipping costs. Replacements on tuners beyond practical repair are available at low cost.

⊕ Tarzian-made tuners are identified by this stamping. When inquiring about service on other tuners, always give TV make, chassis and Model number. All tuners repaired on approved, open accounts. Check with your local distributor for Sarkes Tarzian replacement tuners, replacement parts, or repair service.

SARKES TARZIAN, INC.
Bloomington, Indiana

MANUFACTURERS OF TUNERS . . . SEMICONDUCTORS . . . AIR TRIMMERS . . . FM RADIOS . . . AM/FM RADIOS . . . AUDIO TAPE . . . BROADCAST EQUIPMENT

ONLY
\$9.50
INCLUDING

ALL PARTS
(except tubes)
and LABOR

**24-HOUR SERVICE
1-YEAR WARRANTY**

**TWO SERVICE CENTERS
TO SERVE YOU BETTER**

See your distributor, or use the address nearest you for fast factory repair service

537 South Walnut St.
Bloomington, Indiana
Tel: 332-6055

10654 Magnolia Blvd.
North Hollywood, Calif.
Tel: 769-2720

molasses to overload the starter severely.

The solution to the whole starting problem is simply heat. If you have no heated garage, cover the grille with an old quilt or blanket. Then spread an electric blanket over the whole hood and plug it in. Come morning, the whole motor is warm enough for a fast start. Occasionally add a pint of alcohol to the gas tank to pick up any condensed water in the fuel system. Also add about ½ pint of motor ether to each 5 gallons of gas to provide one fuel component which will vaporize when cold. I have even used the electric blanket idea to keep an aircraft motor warm.

H. B. CONANT

Lincoln, Neb.

Diode Limits Speed

Dear Editor:

Mr. Ronald Ives presented an interesting solution to what can be an annoying problem, in his article "Contact Load Multipliers" (Feb. 1963, page 40). He stated that operational speed is limited by the relay to about 22 counts a second. The circuit, not the relay, is the limiting factor here. While limiting inductive kick, the diode across the winding of the relay is causing it to release slowly, by providing a current flow through the winding in the reverse direction.

Perhaps a better solution would be to replace the diode with a series R-C net. This, too, would protect the transistor, but without the slow release.

Both the R-C net and the diode have applications in telephone-switching circuits at Western Electric where I am employed.

BARRY BROWN

Columbus, Ohio

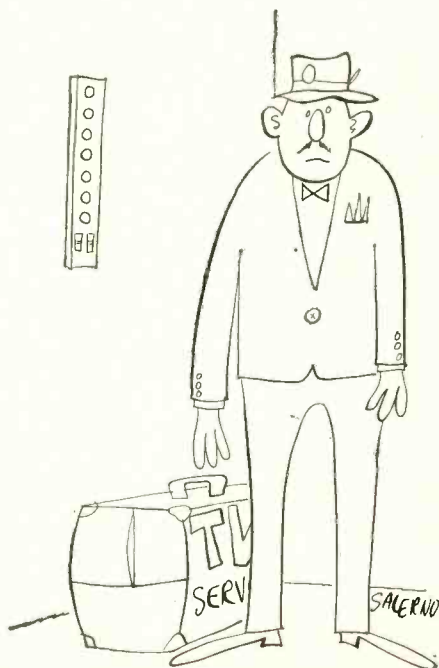

RADIO-ELECTRONICS

Wanna' Sell? . . . Buy? . . . Trade?



For best results use

Radio-Electronics

CLASSIFIED ADS

Rates as low as \$5.

50¢ a word—10 word minimum

Radio-Electronics 154 West 14th Street • New York 11, N. Y.

In COMPONENTS if it's news, expect it first from IRC



NEW... IRC Vinyl Electrical Tape Fast, safe one-hand insulating

New IRC Type 103 Vinyl Electrical Tape has everything a good tape should have . . . and then some.

- 2 to 18 times better dielectric strength than other tapes.
- Seals and insulates in one fast tape-and-tear operation . . . saves tape and time. UL approved as a single insulation for wire splices.
- Saves space in confined areas . . . ends "twice-around" wraps with bulky tapes.
- Provides a tight insulated plastic seal . . . resistant to abrasion, water, acids, alkalies, corrosion and aging.
- Gives a neater wrap . . . adheres readily to irregular surfaces and contours.
- Makes an excellent wrap for insulating tools.

TAPE-AND-TEAR DISPENSER

For fast, one-hand taping IRC Vinyl Electrical Tape comes to you in a sturdy tape-and-tear dispenser. It keeps tape clean and prevents stretching. Cutting blade is shielded for your protection. Dispenser is loaded with 66 feet of $\frac{3}{4}$ " tape . . . ready for instant use.

Also available in cellophane wrapped rolls:

- $\frac{3}{4}$ " wide by 20 feet long
- $\frac{3}{8}$ " wide by 20 feet long
- $\frac{3}{8}$ " wide by 36 yards long

Ask for IRC Vinyl Electrical Tape at your Electronic Parts Distributor.

International Resistance Co., Philadelphia 8, Pa.



108 KITS and FACTORY-WIRED too!

EICO offers you the **BEST BUYS** of both.

All EICO models are available as Kits or assembled and Factory-Wired. So, whether you build it yourself or we do it for you—either way—they look, sound and perform identically . . . all best buys and top performers.



Over 2 million EICO instruments in use. Uni-card holders can buy at any EICO dealer with no down payment. Budget terms at most dealers.

1. **FM Multiplex Stereo Tuner ST97**
Semi-Kit \$99.95 Wired \$149.95 Incl. Metal Cover & FET
2. **40-Watt Integrated Stereo Amplifier ST40**
Kit \$79.95 Wired \$129.95 Incl. Metal Cover
3. **70-Watt Integrated Stereo Amplifier ST70**
Kit \$99.95 Wired \$149.95 Incl. Metal Cover
4. **FM Multiplex Autodaptor MX99** (Patent Pending)
Kit \$39.95 Wired \$64.95 Incl. FET Cover Optional \$2.95
5. **FM-AM Stereo Tuner ST96**
Kit \$89.95 Wired \$129.95 Incl. Metal Cover & FET
6. **Transistorized Stereo/Mono 4-Track Tape Deck RP100**
Semi-Kit \$299.95 (Patents Pending)
(Tape transport assembled & tested; electronics in kit form)
Wired \$399.95
(Handwired throughout by skilled American craftsmen)
Carrying Case \$29.95 Rack Mount \$9.95
7. **100-Watt Stereo Dual Power Amplifier HF89A**
Kit \$99.50 Wired \$139.50 Enclosure E8 \$4.50
8. **Slim 3-Way Speaker System HFS6**
Kit \$52.50 Wired \$62.50
9. **12-Watt Integrated Amplifier HF12**
Kit \$34.95 Wired \$57.95 Incl. Metal Cover
10. **Stereo Dual Preamplifier ST84**
Kit \$59.95 Wired \$89.95 Incl. Metal Cover



©1963 EICO Electronic Instrument Co., Inc.
3300 N. Blvd., L.I.C. 1, N.Y.

EICO 3300 N. Blvd., L.I.C. 1, N.Y. C-4

- Send FREE 32-page catalog & dealer's name
- Send FREE booklet "Why Stereo"
- Send new 36-page Guidebook to HI-FI. Enclosed is 25c for postage & handling

Name _____

Address _____

City _____ Zone _____ State _____

Add 5% in West

THE ELECTRONIC REVOLUTION

... The Great Accomplishments of Electronics Are Still to Come ...

THE modern world has witnessed many technical revolutions in the past, all similar in their basic effects on man—unemployment, often of long duration. Yet the upheaval, after it had run its course, usually proved a blessing in disguise: the world in general improved after every such revolution. Wages rose, often sharply, and the workers found their employment in new spheres generated by the very revolution that started it all.

One of the first revolutions, often called the classic one, began in 1733. It is known as the Textile Revolution. It was brought about by the *flying shuttle* in England, quickly followed by the *spinning jenny* and the *roller spinning frame*. These inventions threw tens of thousands of adult handworkers out of work when incredibly faster machines took over. In some cases, even more children than adults lost their gainful occupation, because child labor was the order of the day.

Quickly, other equally formidable revolutions occurred, dislocating the entire industrial world. Steam power, doing away with backbreaking man-power, had its beginning in 1769, and changed the world fundamentally.

Railways, engineering, electricity, all helped to usher in the Industrial Revolution, which is still continuing today.

In the meanwhile, the world's population did not stand still. It was only a scant 750 million in the 1700's. Today we have more than 3 billion, an expansion fostered to a large extent by the very technical revolutions that broke down the world's frontiers: canals, steamships, railroads, communication, airplanes and others.

And now the Electronic Revolution, the new giant, is advancing with incredible speed into every human endeavor.

It might be said that it started in the early 1920's, with the invention of the dial phone, first successfully demonstrated in Sweden. In 1920, the American Telephone & Telegraph Co. had only manual operators, a total of 228,900 employees. There were 8,000,000 phones at that time. Then it turned to automation—the dial telephone system—eliminating nearly all hand-switchboard operators. Today, AT&T employs 731,569 workers (as of November 1962) and it has more than 67,676,000 phones (as of September 1962)! Such a quantity of phones could not be handled by manual operators—the phenomenal growth of the telephone industry has been made possible by electronics. But automation, instead of decreasing the number of employees, has vastly increased it. More skilled and specialized jobs have been opened up by electronics than were eliminated when electronic circuits and devices replaced operators.*

As the above example clearly indicates, we can also speak of the Electronic Automated Revolution, because very frequently one goes with the other. Indeed, today they are often inseparable. Industrial electronics and automation can not possibly exist without each other.

Let us only think of a single example, the transistor. In the beginning, in the early '50's, they were laboratory-made by hand. The price was above \$10 each. Today, when they are made by automated assembly lines, the price for a much better product is as low as 33¢ each, in quantities. It will be even lower in the near future.

The electronic computer invasion into practically every

type of business is only now beginning. It is still one of electronics' foremost sophisticated and expensive items of manufacture; computers are not as yet completely made and assembled by automated means. They are also still much too complicated, and many are far too bulky and difficult to program. In the not-too-distant future, simplified, compact computers, many types selling for less than \$100, will be in every bookkeeping department and business office. Automation and microminiaturization are the keys to future computers.

The "Instant Newspaper," of which we spoke editorially last month, is on the immediate horizon. It will automate the newspaper into every home by radio facsimile. It will do away with physical distribution of bulky newspapers. This will be a *gradual* revolution, spread over many years, until homes have acquired what we call their *Rafar* receivers. It will save hundreds of thousands of tons of expensive newspaper, and release many thousands of press operators who will be readily absorbed by the printing industry.

The recent breakthrough of the laser and maser, still in their infancy, will have exploded into a vast industry during the next decade. These versatile newcomers are capable of the most fantastic achievements that even today require courage to believe.

We quote from the staid *Journal of the Stanford Research Institute* (No. 3, Vol. VI, 1962):

"Thus, crystals can not only transmit light in whatever portion of the spectrum we desire; they can also generate light and control it and detect it and mix it. Perhaps in the future they will also remember light, because a crystal can be made with certain impurities that are sensitive to particular wavelengths of light. It is conceivable that it could remember an image observable only by light in a very narrow band of wavelength and a different image detectable by different wavelengths. Thus a crystal could conceivably be made that would have in it a number of different images, each visible only with illumination of the proper color. For example, it might be possible to store all of the pages of a book in a crystal."

The present writer, last December, in his *Forecast 1963*, predicted the following, all based on laser development:

Anno 2088: The moon is now the world's largest and most efficient power house. This year it surpassed the earth as a generator of electricity. The surface of the moon is now studded with solar plants of titanic dimensions. Many of these installations measure 75 to 100 miles in diameter. The solar plants are low structures, their tops covered unbrokenly with thermoelectron cells that convert solar radiation into electric current at an efficiency of 86%. Because the moon has no clouds and is in a vacuum, the power generation goes on practically uninterruptedly on both sides of the moon. All plants are 100% automated.

The power is sent earthward via highly efficient electron *Teledynes* (i.e. laser-means) with a loss of less than 1½% of the generated power.

—H.G.

* See also January 1960, RADIO-ELECTRONICS, "Automation in Electronics."

Try fixed bias in all stages



Hi-fi amplifier system with a 30-watt output

By GLEN R. TRAVIS

Ready to build a new audio amplifier? If so, here is one that will fill the bill. It is a 4-tube 30-watt amplifier with matching 2-tube preamp. Fixed bias added to time-tested circuits increases gain and stability and lowers distortion and hum levels.

During the past few years, I've analyzed audio amplifier circuits and often wondered why the performance of a tube in a particular circuit falls short of what is promised in the tube manuals. To find the answer, I ran tests and plotted my own tube curves. When my curves closely resembled those in the tube manual, I realized that the difference in performance must be in the actual circuit. Fixed bias is used when running tube curves. Why then, I asked myself, aren't amplifier circuits designed to use a tube as it is tested—with fixed bias?

To get the answer, I added fixed bias to my favorite amplifier. The circuit with fixed bias throughout is shown in the schematic. Fixed bias improved listening qualities and amplifier performance more than any other single change I've ever tried. The greatest improvement was increased gain. Another improvement was reduced hum. With fixed bias, both heater and cathode are at ground potential. A third noticeable improvement is stability. The music sounds solid. The signal voltage does not change the bias on the grid of the tube as it does with cathode bias.

Increased gain, lower distortion, reduced hum and inherent stability are the reasons for designing this different and better amplifier, better because it is closer to the perfectionist's goal. All the

circuits have been in use for several years but the change to fixed bias makes it possible to combine them into the simple and effective circuit shown in the diagram. This fixed-bias concept can be incorporated into almost all existing amplifiers.

Circuit description

The phonograph preamp (for magnetic cartridge) uses a 7025 dual triode with record equalization through plate-to-cathode feedback. If a frequency test record is available, select R1 to give the best treble response for your particular phono cartridge. The equalization curve

is RIAA without bass rolloff to 30 cycles. The extra bass available when bass rolloff is not used gives greater depth to organ music and bass drums. The amplifier is stable and is not driven into low-frequency oscillation by this extended bass boost. (The turntable must be quiet and the speaker and cabinet combination good.) The tone control can be used as a rumble filter if low-frequency noise exists. Adding other equalization curves is a matter of personal taste.

Crystal or ceramic cartridges with equalizer adapters can be plugged into J1. If equalizers are not available, plug

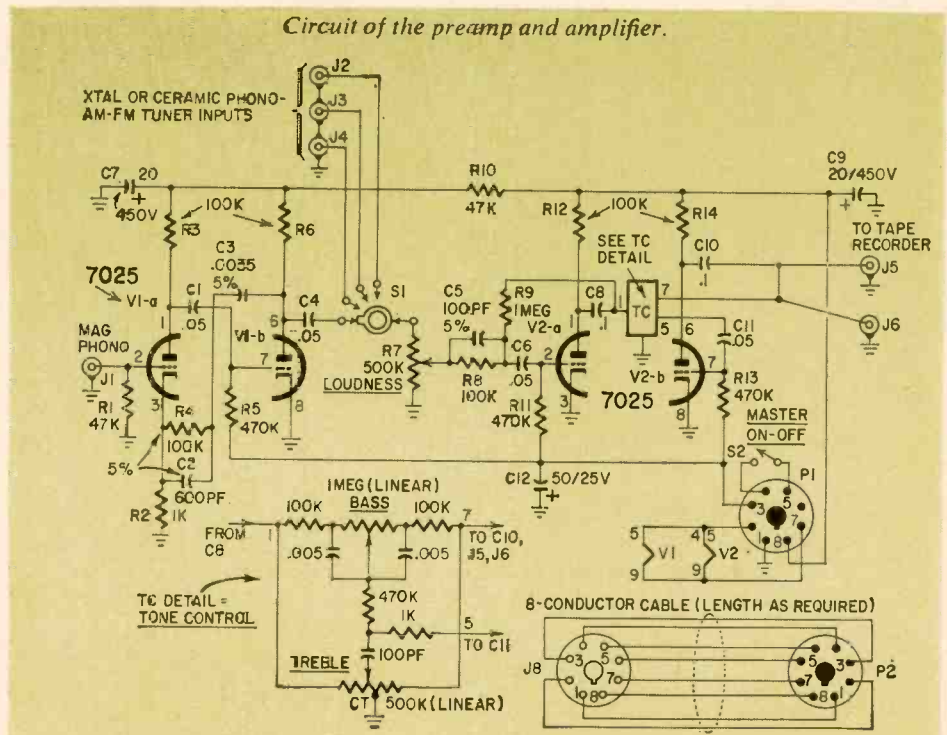



This amplifier and preamp were checked in RADIO-ELECTRONICS' West Coast test facilities and found to have the exceptional performance claimed by the author. Frequency response is within 2 db from 20 to 40,000 cycles. Power output 30 watts. Maximum IM distortion 0.5%. Total harmonic distortion less than 1% for all frequencies above 50 cycles; rises to 2% at 20 cycles.

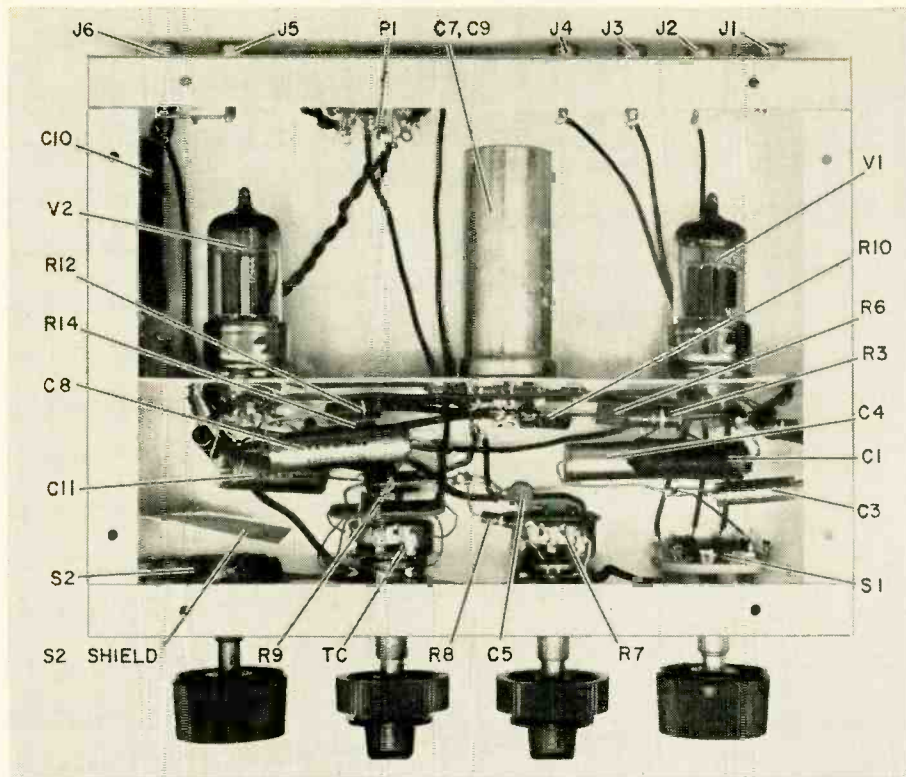

Inside the preamp. The bottom cover has been removed.

the cartridge into J2, J3 or J4 and use the tone controls for equalization.

The Baxandall-type tone-control network can be purchased as Centralab part No. C3-300 or made up as shown in the schematic. A loudness control, Centralab part No. C2-100, can be used in place of R7 to compensate for bass and treble hearing loss at lower than normal volume-level settings. Resistor R8 and capacitor C5 keep frequency

response to V2-a constant regardless of volume-control setting. Feedback resistor R9 reduces V2-a's output impedance for the tone-control circuit. Distortion and any noise generated by V2-a are also reduced. Treble loss between the preamp and amplifier chassis is negligible.

The amplifier itself requires only 0.5-volt input to deliver its full 30- to 35-watt output. A separate volume

(LEVEL) control on the amplifier chassis limits the output level and allows more gradual control of volume by the pre-amp. The amplifier circuit is similar to that used by many manufacturers, with the exception of the fixed bias on the grid of driver stage V3-a. For minimum distortion, the specific value of R21 should be set with a sine-wave generator and a scope or a harmonic distortion meter. C13 is small to keep unwanted low frequencies out of the am-

- R1, R10—47,000 ohms
- R2—1,000 ohms
- R3, R6, R8 R12, R14, R28, R29—100,000 ohms
- R4—100,000 ohms, 5%
- R5, R11, R13, R17—470,000 ohms
- R7, R15—pot, 500,00 ohms
- R9—1 megohm
- R16, R22—47,000 ohms, 1 watt
- R18—330 ohms,
- R19—8,200 ohms
- R20—4,700 ohms
- R21—750,000 ohms (see text)
- R23—220,000 ohms
- R24—51 ohms, 5%
- R25, R27—47,000 ohms, 2 watts
- R26—10,000 ohms, 1 watt
- R30—10 ohms, 1 watt
- R31—pot, 5,000 ohms, linear
- R32—12,000 ohms
- R33—47 ohms, 1 watt
- R34—pot, 100 ohms, 5 watts, linear
- All resistors 1/2-watt, 10%
- C1, C4, C6, C11, C13—.05 μ f
- C2—600 pf, 5%
- C3—.0035 μ f, 5%
- C5—100 pf, 5%, ceramic
- C7, C9, C14, C19—20 μ f, 450 volts, electrolytic
- C8, C10—.01 μ f
- C12, C16—50 μ f, 25 volts, electrolytic
- C15—200 pf
- C17, C20, C22—.025 μ f
- C18—10 μ f, 150 volts, electrolytic
- C21—50 pf see text
- C23—50 μ f, 50 volts, electrolytic
- C24, C25—10 μ f, 500 volts, electrolytic
- C26—10 pf
- CH—8.5 henries, 200 ma
- F—2 amps, 250 volts, slow-blow type
- J1, J2, J3, J4, J5, J6, J7—phono jacks
- J8—female octal connector, cable type
- J9—female octal connector, chassis type
- P1—male octal connector, chassis type
- P2—male octal connector, cable type
- RECT—selenium. 65 ma, 130 volts
- S1—single-pole 4-position rotary
- S2—spst rotary
- S3—spst toggle
- T1—power transformer: primary 117 volts ac; secondary: 800 volts ct, 175 ma, plus 80-volt bias tap; 5 volts, 3 amps; 6.3 volts, 2.5 amps; 6.3 volts, 2.5 amps; 2.5 volts, 1.75 amps (Stancor P-4004 or equivalent)
- T2—output transformer: primary 6,600 ohms, Ultra-Linear tapped; secondary, 4, 8, 16 ohms (Acrosound TO-300 or Dynaco A-420, or equivalent)
- TC—tone control, Centralab C3-300 or equivalent. See schematic
- TS—terminal strip, 4 lugs
- V1, V2—7025
- V3—7199
- V4, V5—EL34/6CA7
- V6—GZ34

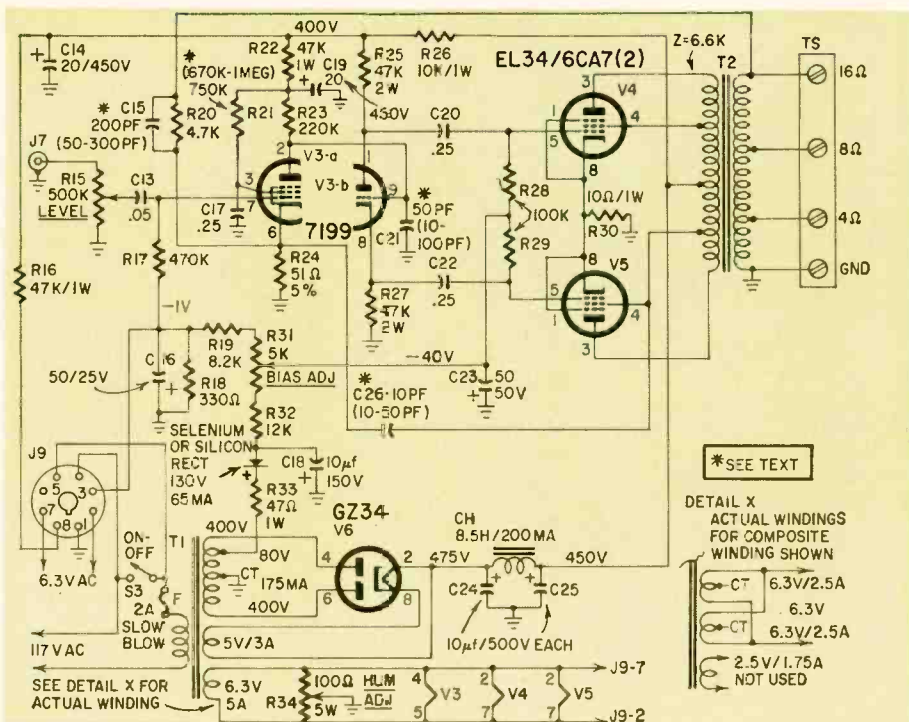

*SEE TEXT
 DETAIL X
 ACTUAL WINDINGS
 FOR COMPOSITE
 WINDING SHOWN

CT	6.3V/2.5A
CT	6.3V
CT	6.3V/2.5A
CT	2.5V/1.75A NOT USED



Closeup of the amplifier.

plifier and speaker system. Fifteen db of voltage feedback is introduced to V3-a through R20. R30 provides a point to measure the current through the two output tubes. A measurement of 1.20 volts across R30 indicates a current of 120 ma. This is the current when the bias is set to 40 volts and the plate voltage is 450. Use a square-wave generator and scope to determine the values of C15, C21, and C26. Pick the values that give the best 10-kc square wave. The several output transformers used during the development of this circuit required different capacitor values for the best sine- and square-wave response. The ranges of values for these capacitors are shown in parenthesis on the diagram. If a filament center tap is part of the transformer winding, ground the center tap and eliminate R34. It may not be needed for minimum hum. If an 80-volt bias tap is not part of the high-voltage winding, the bias supply can be taken from either side of the high-voltage winding through a 120,000- to 150,000-ohm 2-watt carbon resistor. The exact values of the bias network resistors depend on the power

transformer used. A choke in the power supply is the easiest way to reduce hum in the plate-supply circuit. The frequency response of the amplifier itself will vary from below 20 cycles to the upper limit of the output transformer, which can be from 20 to 100 kc.

Construction

No ground bus is used. Each circuit ground is made to the nearest chassis tie point. Chassis tie points must be solid. Hum picked up from the ac circuits can be minimized if all ac lead pairs are twisted together and dressed close to the chassis. If possible, check the value and condition of every component before installation. Several holes in the top of the chassis will aid in cooling the output and rectifier tubes. Separate chassis construction makes the amplifier more flexible.

In my own system I use a Fairchild cartridge, a Presto turntable, the amplifier described in this article and four 15-inch full-range Stephens speakers with two tweeters mounted in two friction-loaded 10-cubic-foot cabinets. END

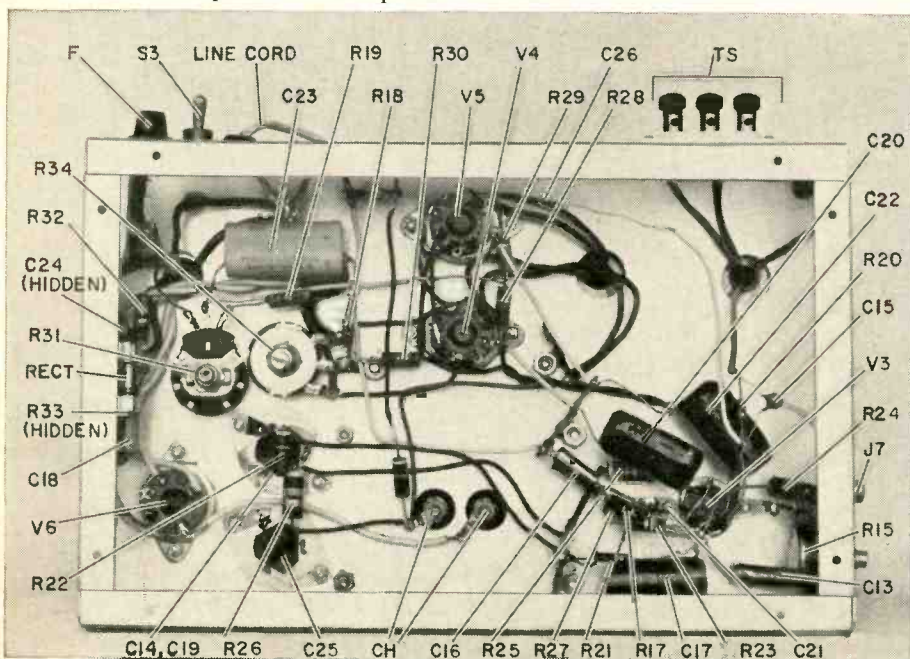

Underchassis view of the amplifier.

Is There an Answer?

A recent article in the local paper was headlined "Fined \$200.00 on Charge of TV Repair Fraud." As usual, the headlines covered almost as much space as the article itself and gave very little information except the bare facts.

The time and work involved in this conviction and fine is a thing to behold. The case first came to light when the customer called in a TV service man to check her set after spending a large amount for service without getting satisfaction. Among the work paid for was replacement of the horizontal output transformer. A glance showed that this was not done. The county sheriff was informed and the man was picked up and charged with fraud. At this point, the sheriff called in two local TESA members to act as expert witnesses and to examine the set.

So far so good. Now to prove the case in court. This case went through an arraignment, a preliminary hearing, a grand jury investigation, and, if the man had not pleaded guilty at this point, it would have gone to a jury trial.

As to time and money involved: At the preliminary hearing, which took most of one day:

Judge, customer, Assistant County Attorney, 3 TV service technicians, 1 other witness.

At the Grand Jury investigation (one half day):

6 jurors, 3 TV service technicians, Assistant County Attorney, customer, 1 court clerk.

In addition to the above, time was spent by clerks typing subpoenas, it took time and transportation to serve them, and the Grand Jury and witnesses had to be paid for their time. All this and all the other paper work involved in such a case—and then the customer's set was held as evidence for 6 weeks.

All this was done to prove a man charged a woman \$15 too much. But there is no way to prevent this man from continuing to do business!

What is the answer? Our State Legislature will not give the cities and towns the right to protect themselves with some type of license. Our State Tax Commission turns a deaf ear to our plea to issue tax permits to ALL retail operators. The distribution processes have broken down to the point where almost anyone can obtain parts at "wholesale". The advertising media will accept *bait* ads from almost anyone. . . . The public will continue to try to "save money" or get something for nothing.

Is there an answer? The only one that comes to mind is for legitimate shop owners to bind together into a strong association and meet problems head-on with every means.—*Reprinted from TSA Service News, Seattle, Wash.*

THE BENDIX 28 SERIES OF FM TWO-WAY radios uses the model 16-RS-1 receiver chassis. It has two tubes. One is an rf amplifier, the other a multiplier for the local oscillator and first mixer. The rest of the circuit is transistorized and divided into printed-circuit boards—local oscillator, first i.f. amplifiers, second i.f. amplifier, and the squelch and audio driver. All are easily accessible for servicing. An 8-watt class-B transistor amplifier is the final audio stage.

We had five of these sets in operation for over a year and a half as fixed base stations. During all this time, the only thing to give us trouble in the receiver was the squelch circuit, or at least that's what it seemed to be from the symptoms.

On two sets the complaint was very slow squelch action. It took about 10–15 seconds after receiving a signal before the squelch would cut off. On the first one, all voltages in the squelch circuit checked good and the trouble seemed to be low input to the noise amplifier. Instead of 0.65 volt, the meter showed only 0.4 volt at the discriminator output. After about 5 seconds the voltage started to rise slowly until it reached 0.65 volt and the squelch cut off. Voltage checks in the second i.f. board seemed to indicate poor power supply regulation. With the squelch open, supply voltage to the second i.f. was about 10.5 volts and jumped to 12.5 volts as soon as the squelch cut off. At those voltages this is quite a drop, but a different set worked just perfectly with the same change. (This drop is due to the heavy drain of the class-B output stage when amplifying the noise.)

Several hours later we noticed that the voltage at Q204's emitter (Fig. 1) changed slowly as the noise at the discriminator came up. Checking the transistor showed its leakage was a bit too high. Replacing it with a good one cleared up all our troubles. The second set showed the same symptoms, but this time it was Q205. Again a new transistor cured the set. So watch those jumping voltages and don't let them fool you into a wild goose chase.

The third set came into the shop with erratic squelch action. Sometimes the squelch cut off right after receiving

Unusual Squelch Troubles

By ARNOLD W. WIEGERT

a signal, sometimes it would stay on for minutes or hours and nothing would help. Everything worked fine up to the noise amplifier. Voltage checks around Q251 (Fig. 2) showed that the bias had changed enough to cut the transistor off completely. Remembering the article on Ultra-Kaps in the January 1961 issue of RADIO-ELECTRONICS, C254 (1- μ f 3-volt Ultra-Kap) was not even suspected. But after every other part was found to be good, we finally tested C254 and found it was practically shorted. Replacing it with a 10- μ f electrolytic, because we had no exact replacement at the time, cleared all problems and the set has been working fine ever since.

You will have to watch out for one thing when working on the second i.f. board in these sets. If you have to get at the back side while the set is operating, make sure that the two lugs under the bottom mounting screws as well as the ground strip on the back are grounded. The best and easiest way is to take two nuts and thread them over the

mounting screws. Then run a short jumper from there to ground. After you are finished, make sure the mounting screws are good and tight again. Otherwise you are heading for more trouble, again with the squelch. It will be very erratic. Sometimes the squelch will cut off, sometimes it won't until you bang the radio or somebody walks around the room. The reason is simply that the wires attached to the two lugs are actually short ground connections for the ground system in the printed-circuit board and, unless they are securely grounded, all kinds of troubles develop. One of them is low noise output from the discriminator and intermittent squelch due to a drop in gain in the sound i.f. amplifiers.

All these troubles appeared in the summer and we suspect that high temperatures had something to do with it. They kept us busy for many an hour and we hope that these tips will help to make life easier for some readers with similar problems. END

Lugs under two lower printed-board mounting screws (arrows) must be grounded securely.

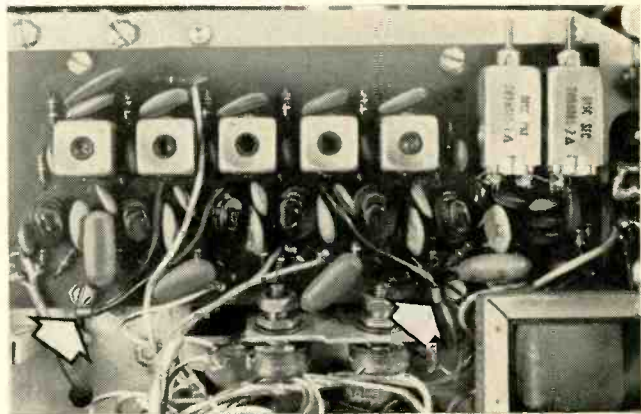

Fig. 1—Circuit of second i.f. amplifier board. Trouble here was leaky transistors.

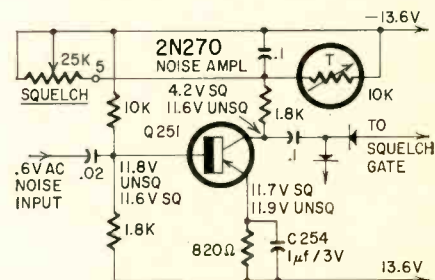
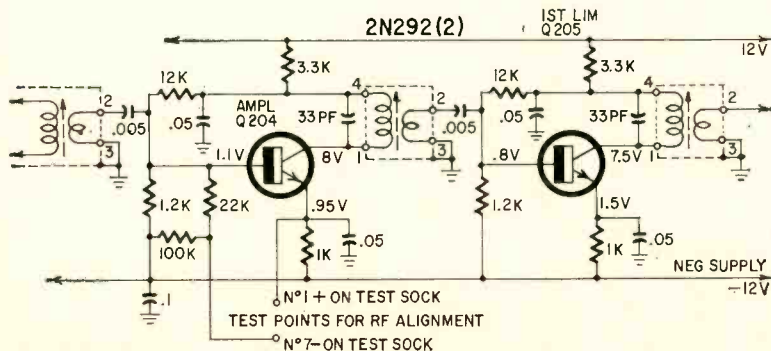

Fig. 2—Noise amplifier circuit in the Bendix 16RS-1.



watch out for TRANSIENTS

They can put a sudden end to meters and rectifiers

By E. H. LEFTWICH*

FOR MANY YEARS, I WENT MERRILY about my work checking circuit voltages with a vom or vtvm. In every case, I connected one meter lead to ground or chassis and checked through the circuits, holding the other meter lead (insulated prod) in my hand. All went well.

Recently, I checked the high-voltage secondary of a 1,000-volt power transformer for no-load output. Because I was somewhat afraid of holding one lead in my hand, I connected both leads of my vtvm to the transformer secondary terminals, and set the meter range switch to 1,400-volt position (ac).

So, I plugged the transformer primary into the ac line—and jumped back! Lights in the shop went dim—like a dead short circuit—the meter needle flipped over and hit the post, and I heard a “sizzling” noise in the meter—all this in the fraction of a second it took to jerk the plug out of the ac line socket. I pulled the meter chassis out of the case and found that the range switch had arced across the 1,400-volt ac contacts, burning them off. The “burnout-proof” meter movement was fortunately not damaged.

Next, because I was “hard-headed” and unbelieving, I connected my vom the same way—to the high-voltage secondary terminals. I set the range switch for the 5,000-volt ac scale. I plugged in the transformer primary to the ac line as before—and as before, I jumped back. Again, the shop lights dimmed, fire flashed and smoke rose from the vom case. I snatched the plug from the ac line socket again. I removed the vom from its case and inspected the damage. The meter needle had struck the post so hard that it was bent over in the shape of a sawtooth wave. Coil turns on the lower meter-movement spring were welded together, and the range switch contacts in the 5,000-volt ac circuit were burned off. In addition, a resistor in the circuit had

exploded and burned to a fine white powder!

I was now in a sorry position. Both my meters had blown and there was work to be done in the shop. I ordered replacement parts for the meters, but could not afford to wait for them to arrive. So, I bought a new, top quality vom and reasoned that later I could “work off” the repaired meters (at a ridiculously low price) to some associates.

Now, I was smart. I didn't know why the meters had blown—but I had learned the hard way. I wasn't taking any chances with the *new* meter! So, I dragged out a transformer with a rated secondary voltage of only 400. (Here, again, the instruction manual furnished with the new meter read CAUTION—ALWAYS CONNECT THE METER LEADS FIRST BEFORE TURNING ON THE POWER.) For this test, I again connected the test leads to the 400-volt secondary terminals of the transformer, and set the meter range switch to the 1,600-volt position (ac). “Surely,” I reasoned, “there will be no trouble this time—with only 400 volts in the circuit.” I was wrong! When I plugged the transformer primary into the ac line socket, the shop lights dimmed *slightly* (about the same as though a 1,000-watt electric heater had been connected) and the meter needle flopped gently against the post. Instantly, I pulled the plug out of the ac line socket, and this time the meter was not damaged.

Here, I had a transformer secondary rated at only 400 volts, yet the meter needle had pinned the post on the 1,600-volt scale. How was this possible? “Okay,” you might say, “what

about the peak voltage?” But, this would not explain the phenomenon because $1.77 \times 400 = 708$ peak volts, and this would not pin the meter needle to the post on the 1,600-volt scale. Conferences with a number of friends resulted in various theories, none of which appeared logical: “surge voltage”; “defective or incorrectly rated transformers”; “magnetic-field current buildup”; “impossible—could not happen; if meter range is 5,000-volts ac, then meter should take 1,000 volts ac without blowing.”

Finally, with the assistance of an electronics design specialist I know, and reference to a comprehensive book on transformers† the phenomenon was explained. Briefly, a transformer, when not loaded, constitutes what is essentially a resonant-tuned circuit (Fig. 1).

Analysis of transient effects at an input of only 100 volts indicated a voltage as high as 22,600 volts rms at the secondary terminals of a transformer! Because of this, you must safeguard your test instruments. The following two rules will protect you and your test gear:

1. Do not connect meter leads to a transformer before power is turned on unless the secondary is shunted by a reasonable load (5,000 to 50,000 ohms).
2. If you want to check the actual ac output of an unloaded transformer secondary, turn on the primary power FIRST, use the high-voltage test probe in one hand and put your free hand in your pocket. (When primary power is turned on before the test leads are connected, no meter damage will result, assuming that the proper meter scale is used.)

These two simple rules apply principally to ac voltages, except for instantaneous make-and-break circuits where a battery is used. In ac power

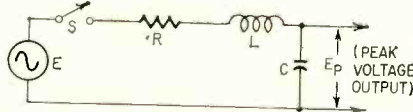

Fig. 1—Simplified circuit represents the input primary of an unloaded transformer.

*Advanced design, Ryan Electronics, Ryan Aeronautical Co.

† Lee, Reuben. *Electronic Transformers and Circuits*, Wiley, 1947.

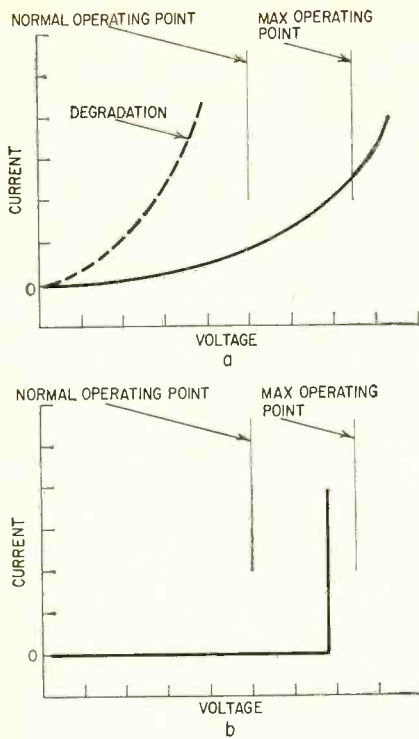

Fig. 2—The difference between ordinary semiconductor diodes (a) and diodes designed for transient suppression.

supplies, the filter and bleeder resistor provide the load, and it is, of course, safe to connect the meter leads either before or after primary power is turned on.

TV circuit problems

Transients in TV power supply circuits often exceed silicon rectifier ratings, causing frequent breakdowns and recurrent headaches for the service technician. This problem is not restricted to silicon rectifiers, but also occurs, to a lesser extent, with germanium rectifiers.

The low interelectrode capacitance and high reverse resistance of such rectifiers are normally satisfactory for blocking a continuous voltage, but instantaneous high-voltage transients can destroy the rectifier in a few microseconds. These transients usually occur the instant the line voltage is applied to the transformer primary, or the instant the line voltage is cut off. For example, the technician could leave the TV on and operating normally in the owner's home. Then, when the owner turns off the set, a transient overvoltage could blow one or more rectifiers. The next time the set is turned on the service technician has a call-back.

A peak inverse voltage (PIV) many times the normal reverse voltage can appear across a rectifier because of this on-off switching. Although there is, in effect, what might be considered an inductive load on the transformer secondary, the reverse characteristics of the rectifier do not have a low enough

impedance damping (discharge) effect to handle these transients.

Possible solutions

The obvious solution is to replace the silicon rectifiers with types which can handle the transient voltages. Happily, some silicon rectifiers have good avalanche breakdown characteristics. These diodes have, in effect, "self-damping" qualities. That is, they are "harder" types which have an abrupt voltage-current curve rather than a slowly rising one (Fig. 2). This gradual relationship between voltage and current is often due to surface effects which are related to premature failure.

Surface effects (leakage paths) result from inadequate cleaning of the diode surfaces during manufacture. The initial "dirt" (moisture contamination) remaining on the surfaces tends to increase gradually with time and use. The actual self-life of a "dirty diode" is therefore lessened also.

Silicon diodes having satisfactory

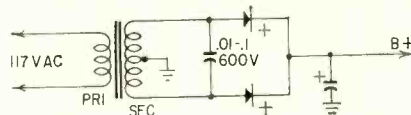

Fig. 3—One way to protect diodes is to add a .01- to 0.1- μ f capacitor across the transformer secondary.

characteristics for transient suppression or handling instantaneous overvoltages are available from Rheem Manufacturing Co., Mountain View, Calif. Fairchild Camera & Engineering Co., also in Mountain View, makes similar types. These diodes can be used as direct replacements for 1N457, -458, -459, -461, -462, -463 and -464. I recommend that 1N2069, 1N2070 and 1N2071 diodes used in TV power supplies be replaced by 1N2614 or equivalent types. In addition, there is the G-E selenium Thyrector diode[§] designed specifically for transient-voltage suppression.

As an alternate solution you can connect a .01- to 0.1- μ f disk ceramic damping capacitor across the secondary of the power transformer *ahead* of the rectifiers as shown in Fig. 3. Its voltage rating must be higher than the secondary peak-to-peak voltage.

Other methods which have been used successfully are:

1. Opening and closing the transformer secondary *after* the primary voltage has been turned on. (This can be done with a relay.)
2. As a temporary measure, protect existing rectifiers with fuses (rated to handle the current) in series with the rectifiers. [This may not always work since a silicon rectifier will often burn out before the fuse.—*Editor*] END

[§] Complete data on the Thyrector and its application appear in G-E Application Note 200.5, available from General Electric, Rectifier Components Dept., W. Genessee St., Auburn, N. Y.

Electronic Ear Brings Sound to the Deaf

Last November, a neurosurgeon implanted an artificial electronic "ear" into the skull of a 46-year-old woman, deaf from birth. Now she can hear sounds, distinguish words, and soon should be able to understand them.

The device was developed by Dr. James Doyle, of General Data Corp., Orange, Calif. Dr. Doyle's brother, John B. Doyle, Jr., of USC Medical School, was the neurosurgeon who performed the operation.

The system's microphone picks up audio signals, then an analog-to-digital converter changes them into digital signals understood by the brain. The transmitter is worn in a headset, and a receptor unit inside the head is coupled to the acoustic nerve, which passes signals to the brain. The four channels in the converter and receptor unit, with a range of 200-600 pulses per second, offer a sound range of 500-2,500 cycles—adequate for speech and some music.

General Data Corp. has been working on the device for 2 years. It is designed for use where the acoustic nerve is unimpaired but the inner and outer ear are defective. About 3 million Americans suffer from this condition, which makes an ordinary hearing aid useless.

The next "ear", says Dr. Doyle, will be much thinner, and will be implanted under the skin instead of recessed in the skull. Further research, requiring 6 months to a year, is needed before it can be marketed.

Success of the "ear" has encouraged Dr. Doyle to plan artificial "eyes", like tiny TV sets, and electronic circuitry to replace polio-damaged nerves.

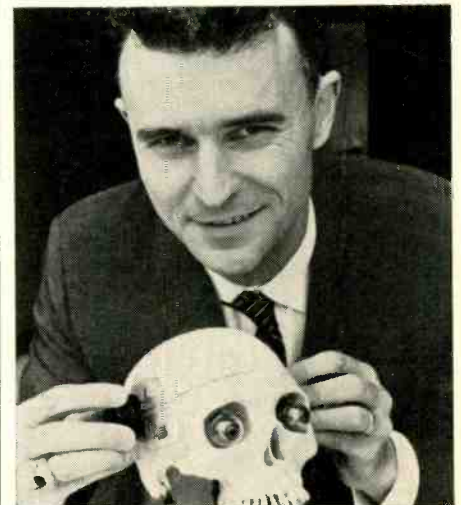

Dr. Doyle demonstrates the electronic ear on a plastic skull.

BUILD

a signal injector into your vtvm

Audio oscillator makes a useful accessory for signal tracing

By HAROLD REED

When you equip your vtvm with this little device, you automatically have a continuous 1,000-cycle signal-tracing sine wave without need for a separate audio oscillator. It may be built into other test equipment if desired.

An audio oscillator is indispensable in servicing amplifiers or audio systems. In many instances spot-checking at a single frequency will localize the trouble in an electronic system. In these cases it is unnecessary to set up the relatively large variable audio signal generator on an already overcrowded work bench, or to take it on service calls.

The circuit uses a phase-shift oscillator. It has often been said that transistor phase-shift oscillators have not been given the consideration they deserve nor are they widely used. Here is one way to make good, practical use of this circuit. It provides the service technician with another basic tool for rapid servicing.

The phase-shift oscillator is an

R-C circuit. Therefore, no transformer is required for feedback to sustain oscillation. Since a 180° phase reversal is necessary between the transistor stage's input and output, the common-emitter configuration is used. The cascaded R-C feedback network between collector and base provides the additional 180° phase shift needed to make the circuit oscillate.

The feedback network results in considerable signal loss. A transistor with enough gain to overcome the circuit losses is required. The 2N35 satisfies this requirement and is a low-cost type.

Base bias and stabilization are provided by resistor R4. The value of this resistor affects starting of oscillation, distortion and output level. The 620,000 ohms shown in the schematic was found optimum for this 2N35. This resulted in a maximum output of 5 volts across a 47,000-ohm load resistor with 0.3% distortion. Frequency measured 1,075 cycles. Starting of oscillation is instantaneous and output level is steady.

A potentiometer can be used temporarily for R4 and adjusted for optimum results for any particular transistor. Distortion varies somewhat as loading is varied. Signal output from the oscillator is taken from potentiometer R5 in the collector circuit, through capacitor C5.

Other inexpensive transistors were tried in the circuit and, although they worked well, best results were had with the 2N35. Note that only n-p-n types can be used if the power supply B-minus is grounded as shown in the schematic.

Power source

Power for the oscillator presents no problem and may be supplied by any unit into which the device is built. The dc potential needed is from 20 to 25 volts and the current drain is just 0.5 ma. This voltage may be obtained with a simple voltage divider consisting of two resistors connected across any available power supply.

I built the oscillator into a Heath-kit model AV-3 audio vtvm. The re-

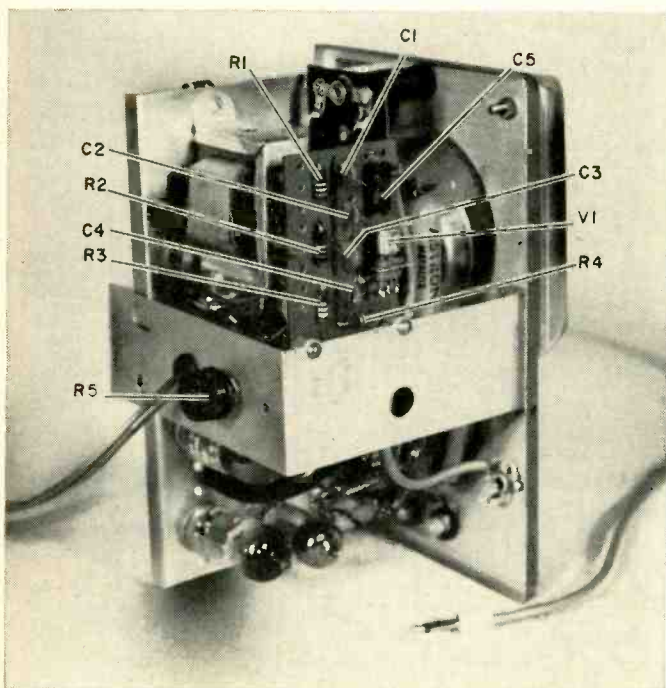

The injector is built on its own sub-chassis, bolted to the vtvm frame.

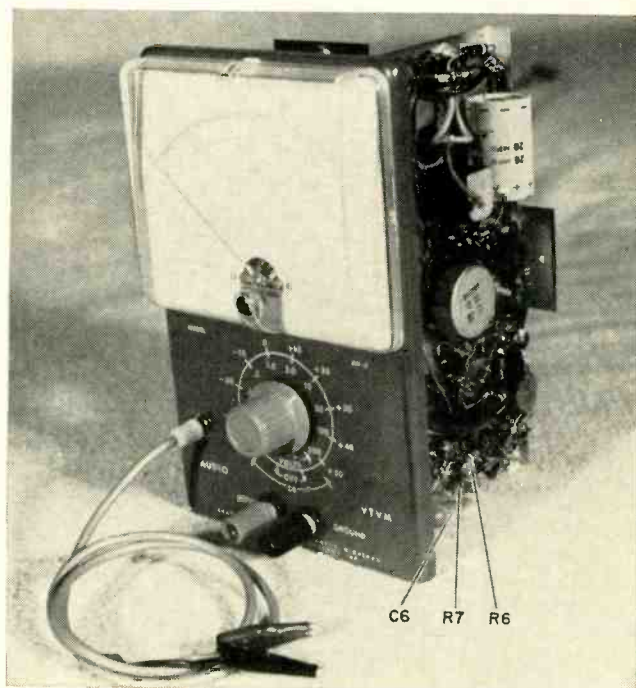

The two additional resistors and filter capacitor are at bottom right

quired supply voltage was obtained as shown in the diagram. This same arrangement may be applied when using any other test instruments. Resistors R6 and R7 should then be selected to obtain the correct voltage. If desired, the oscillator may be powered independently by a miniature 22.5-volt battery such as the Burgess U15.

Construction data

All component parts of the oscillatory circuit are assembled on a $1\frac{1}{2}$ x $2\frac{1}{2}$ -inch piece of perforated phenolic board attached to the framework of the vtvm. The leads of resistors and capacitors are pulled through the holes of the board and connected at the back. A small aluminum bracket, also fastened to the board, was provided for the transistor.

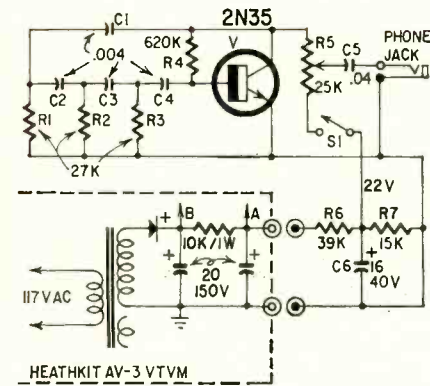

C1, C2, C3, C4—.004 μ f, ceramic disc
 C5—.04 μ f, miniature
 C6—16 μ f, 40 volts, miniature electrolytic
 R1, R2, R3—27,000 ohms, 5%
 R4—620,000 ohms, 5%
 R5—25,000 ohms, miniature pot with spst switch, Lafayette VC-25 or equivalent
 R6—39,000 ohms, 10%
 R7—15,000 ohms, 10%
 V—Sylvania 2N35 (n-p-n)
 All resistors $\frac{1}{2}$ watt
 Plug and jack set, subminiature, Lafayette MS-370
 Knob, miniature, for $\frac{1}{8}$ -inch shaft, Lafayette MS-185
 Transistor socket, Lafayette MS-275

The signal injector is a one-transistor, 1-kc, phase-shift oscillator.

Miniature output control R5 is mounted on the rear of the vtvm framework. This control has an attached switch, S1, which opens and closes the B-plus supply to the transistor. This switch is not absolutely necessary. The oscillator could be left running continuously while the vtvm is turned on.

Oscillator output terminates in a miniature jack mounted on the front panel of the vtvm. A short length of small-diameter, single-conductor, shielded cable connects the output to this jack. A 2-foot length of this same type cable, equipped with miniature plug and Mini-Gator clips, conducts the signal to the equipment under test.

Power supply resistors R6, R7 and filter capacitor C6 are connected directly in the power supply circuit of the vtvm. Unused pin 5 of tube 6C4 of this particular vtvm is used as a tie point for the voltage divider.

Once you build this simple, single-stage, phase-shift oscillator into your audio vtvm, you will always have available a 1,000-cycle audio test signal whenever and wherever you use your vtvm. END

COVER STORY

New Scientific Toys Teach Kids to Think

THOSE VIEWERS-WITH-ALARM WHO ARE sure that America is being left behind in the science and technology race, and point as evidence to college enrollments in engineering and physics, are pointing the wrong way. A much more valid gage is what the kids grow up with: there is where the guiding interests begin. The last generation put the United States ahead in technology *despite* a condescending attitude in the colleges to the mechanical arts. Why? Because the youth put in their busiest hours around the Model T in the back yard—and grew up to be mechanics, machinists and engineers.

The youth of our vastly more technical world has greater difficulties. You can't build a computer in the cellar, or a laser in the backyard. But they have one advantage their parents did not—access to scientific and technical equipment in cheap and easily handled forms. Many of our kids are engaged in activities—for fun—that their parents thought of as tedious college subjects (if indeed they learned of them at all). The material for these activities comes from the counters of our hobby shops and electronic supply houses, as educational projects and laboratory kits. The very changes that have taken place in these kits in the last few years show how significantly the youthful taste has developed.

The kit on our cover, made by International Rectifier Corp., of California, is not vastly different from one that appeared on our June 1961 cover. But the instruction book supplied with it starts out: "The fascinating world of electrical and electronic science," goes on to ask "what is electricity and electronics . . . how does a solar cell work . . . what is a circuit?" before even suggesting that the purchaser unpack his lab.

The experiments are headed with such titles as "Learn the principles of electromagnetic devices" (instead of "Build a 10-pound electromagnet"). The fun-seeking child is invited to "learn how a transistor works." Let's face it—the explanations are often extremely simple—but the approach is basic. When the purchaser graduates from these units, he is going to come to more advanced projects with the urge to "learn how" rather than "build a . . ."

And he will have the equipment to help him. An educational kit, put out by the Heath Co. for advanced students, is accompanied by a text book and manual, aimed not at beginners,

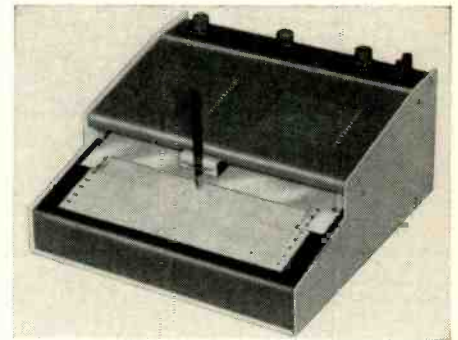

Heathkit Servo Recorder Kit.

but at scientists in other fields (*Electronics for Scientists*, by Malmstadt, Enke and Toren). No doubt the adolescents will swallow the text of that equally as well as the more learned, but less adaptable, scientist.

These post-graduate kits are represented by outfits intended for advanced students and design engineers. A few years ago, an analog computer kit selling at a little less than \$1,000 was introduced. Now we have several, including such items as "a complete microwave kit, Model TI . . . for military, college, industrial and vocational school training . . . consists of a complete microwave training system capable of transmitting and receiving signals in the X-band." The kit is priced at \$1,873. Similar kits are being offered researchers in thermoelectrics and other fields.

But the child is being offered as wide a variety of activity at a slightly lower technical (and economic) level. He can study phosphorescence, ultraviolet light, build himself a functional weather station, learn how to orbit satellites or study binary mathematics and computers with toy kits. END

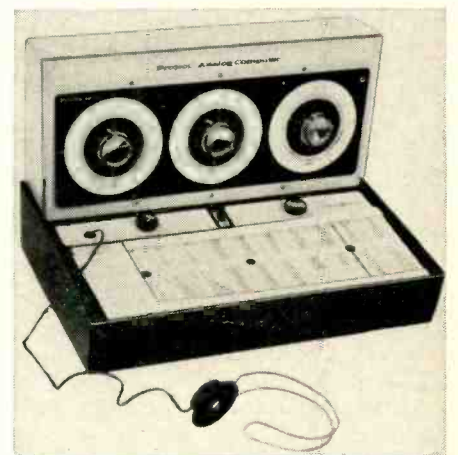

The General Electric Educational Projects analog computer kit.

FM stereo in HI-FI packages

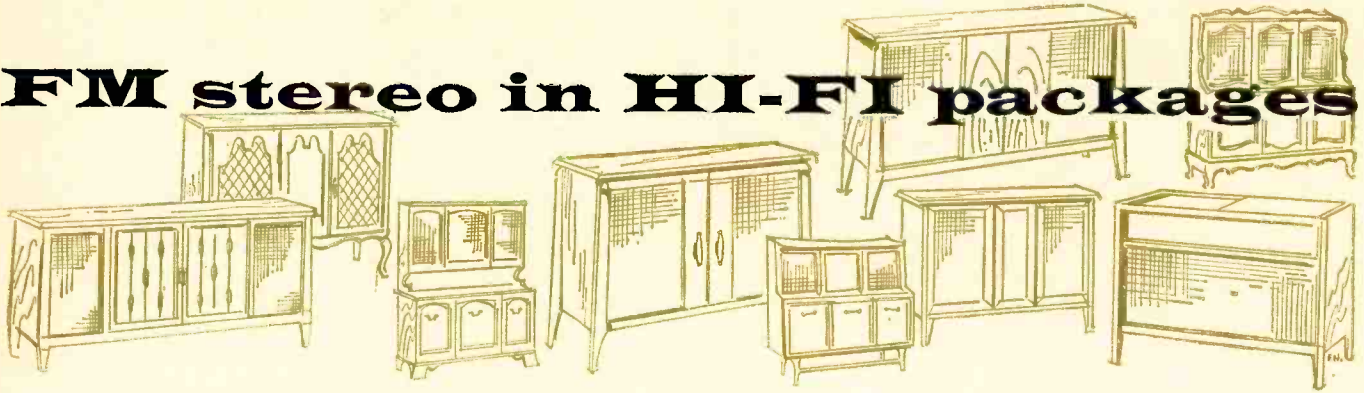

How the package systems are modified for stereo broadcasts

By **ROBERT F. SCOTT**
TECHNICAL EDITOR

For a few months, FM stereo was limited to listeners within range of one of a few stations who had added adapters to their component type hi-fi setups. The number of stereo stations has increased rapidly and most major manufacturers include FM stereo circuitry in their packaged equipment. This article analyzes the FM multiplex circuits used by three manufacturers of packaged hi-fi assemblies.

Fig. 1 is the circuit Motorola uses to adapt Motorola FM-AM tuners and receivers for FM stereo reception. Emitter follower Q is a wide-band impedance-matching device that couples the tuner output to the multiplex circuitry.

The composite FM stereo signal, consisting of L + R, L - R and the 19-kc pilot subcarrier, is taken off Q's emitter. Any possible 67-kc storecast subcarrier is removed by series filters L1-C1 and L2-C3. The 19-kc shunt filter L3-C6 filters out the 19-kc pilot subcarrier, leaving only the 38-kc L - R sidebands and the L + R monaural audio signal at the junction of C4 and C5.

When the tuner is tuned to a stereo broadcast, the 19-kc pilot subcarrier is taken off the shunt trap (L3-C6) and amplified by the 6AU6 (V1). A 19-kc signal with a peak value of approximately 200 volts is developed across T1's secondary. This voltage appears across the NE-2H, causing it to light and show that a stereo broadcast is being received. Around 60 volts of bias is applied to the indicator lamp to make it sensitive to weaker stereo signals. The bias voltage is regulated by a second NE-2H.

The 38-kc locked oscillator is a Colpitts type. The oscillator inductance is the primary of T2 tuned by C18 and C19. Normally, the oscillator is biased to cutoff by 12 volts of cathode bias obtained by returning its cathode to a tap on a B-plus voltage divider consisting of R11 and R12.

On an FM stereo signal, diode D rectifies the pilot subcarrier and develops a positive voltage across R7 and C14. This voltage is filtered by R8 and C14 and applied to the grid to turn on the oscillator. The time constant of R8-C14 is long enough to prevent the oscillator from being turned on by 19-kc noise bursts on a monaural signal or by

interstation noise. The 19-kc pilot tone locks the oscillator in phase by feeding some of its voltage to the oscillator grid through C12 and R9. R11 sets the oscillator cutoff bias voltage and determines the strength of the 19-kc signal required to turn it on.

Normally, the plates of the synchronous detector are biased 2 volts positive (forward bias) so the diodes conduct continuously. When a monaural signal is tuned in, the FM detector output (audio) appears at Q's emitter. The 67-kc traps have negligible impedance at audio frequencies so the audio signal appears at the center tap of T2's secondary. This circuit offers little or no impedance to the audio voltage so it passes through both forward-biased diodes to the left and right outputs. Thus, a monaural signal is fed to both audio channels.

On a stereo program, the signal at A consists of the L + R (audio) voltage and the L - R 38-kc sidebands. When the oscillator is keyed on by the 19-kc pilot subcarrier, a 38-kc signal of approximately 9 volts peak to peak is developed across T2's secondary. The diodes now conduct only when the impressed signals make the plates positive

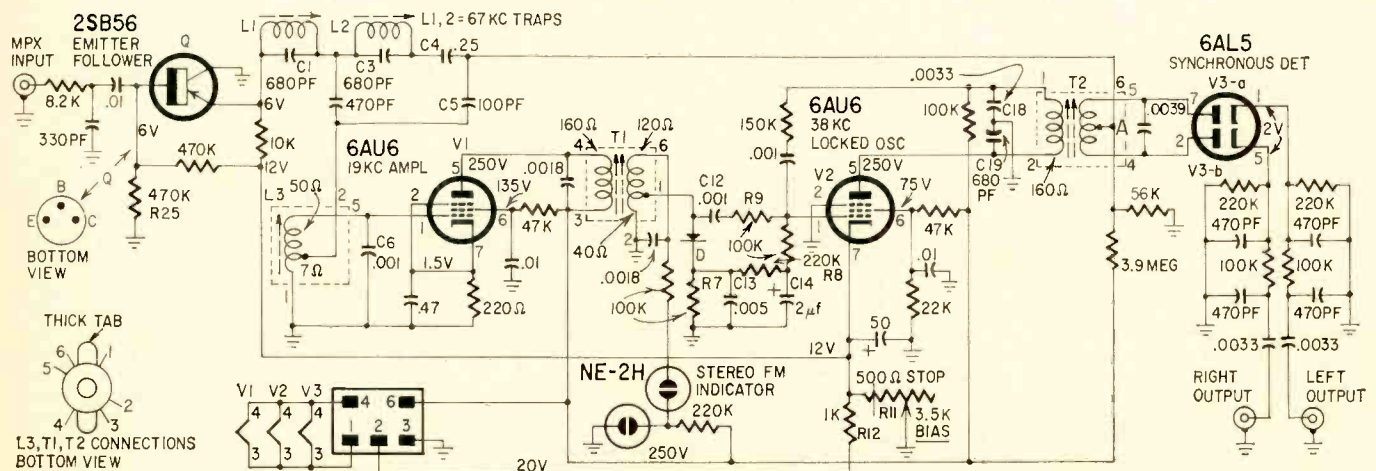
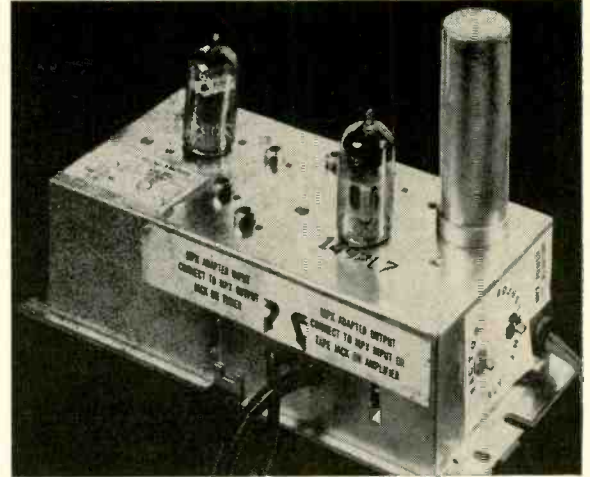
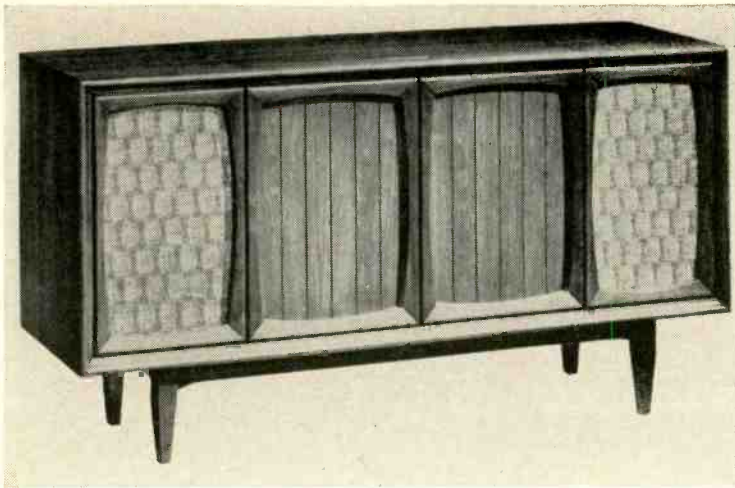

Fig. 1—Motorola uses this HS-996 adapter in many of its package units.



A big "package" by RCA (left) which uses this RK-295 adapter (right). Circuit is in Fig. 3.

with respect to the cathodes. Instead of conducting continuously as during a monaural broadcast, the diodes are keyed on and off at a 38-kc rate when a stereo signal is tuned in.

The 38-kc signal developed across T2's secondary is amplitude-modulated by the L - R sidebands to develop a symmetrical AM rf envelope at the diode plates. The upper half of the envelope carries the L - R signal and the lower half carries the -(L-R) signal.

When V3-a is turned on by a positive half-cycle of the 38-kc signal, it rectifies the upper half of the envelope to produce a L - R audio voltage. This combines with the L + R audio fed to point A to develop a 2L signal at the left output jack. When V3-b's plate is driven positive by the 38-kc signal, the diode conducts and detects the bottom half of the envelope. We now have a -(L - R) that combines with the L + R signal to produce a 2R voltage at the right output jack.

The Zenith adapter

The stereo adapter circuit originally proposed by Zenith engineers used a beam-switching tube to detect the L and R signals. However, in practice, they have developed simpler and more efficient adapter circuitry. The circuit in Fig. 2 is used in the model 9H21 chassis.

The output of the ratio detector takes two paths. The 19-kc pilot subcarrier is amplified in a tuned-grid tuned-plate pentode amplifier (V1-a) and then doubled to 38 kc by the full-wave detector circuit consisting of D1 and D2. Satisfactory operation of a stereo adapter requires that the 19-kc pilot subcarrier exceed a specific minimum level. Therefore, the pilot amplifier is designed to cut off when the 19-kc signal is below the minimum level. In this circuit, V1-a is normally held at cutoff by a positive cathode voltage obtained from the MUTE control.

When the 19-kc signal exceeds this

bias on positive peaks, the tube conducts and a series of 38-kc pulses are developed at the output of the doubler. These pulses are filtered by the 1-megohm resistor and .01- μ f capacitor to develop an override dc grid bias that is within 2 volts of the mute bias applied to the cathode. The tube now amplifies normally and develops 19- and 38-kc signals at the levels required for proper operation. Thus, V1-a is cut off on monaural signals and very weak stereo broadcasts and only turns on when the incoming stereo signal is strong enough for satisfactory operation.

When a stereo signal is fading, reception is noisy and distorted and will be much better received monophonically. A MPX-MONO switch (on the rear panel) selects the mode of reception. In the MONO position it cuts off V1-a by removing its screen voltage.

The neon stereo indicator light is connected between the bottom end of the doubler transformer primary and

the screen grid. When a stereo signal is received, the screen draws current and develops a voltage drop across the 68,000-ohm screen dropping resistor. At the same time, the 19-kc pilot subcarrier develops 200 peak-to-peak volts on the transformer end of the lamp. The lamp fires and indicates that the set is tuned to a stereo program.

The 38-kc pulses from the doubler are clipped in V1-b's grid circuit and then amplified. Flywheel action in the detector transformer's primary produces the 38-kc sine waves that will replace the subcarrier suppressed at the transmitter.

The two L - R 38-kc sidebands and the L + R audio signal follow the second path from the tuner's FM detector. The trap consisting of L24, C51 and C52 filters out frequencies between 59 and 75 kc to prevent any possible SCA storecast signals from causing crosstalk in the multiplex detector. The L + R and L - R signals are amplified by

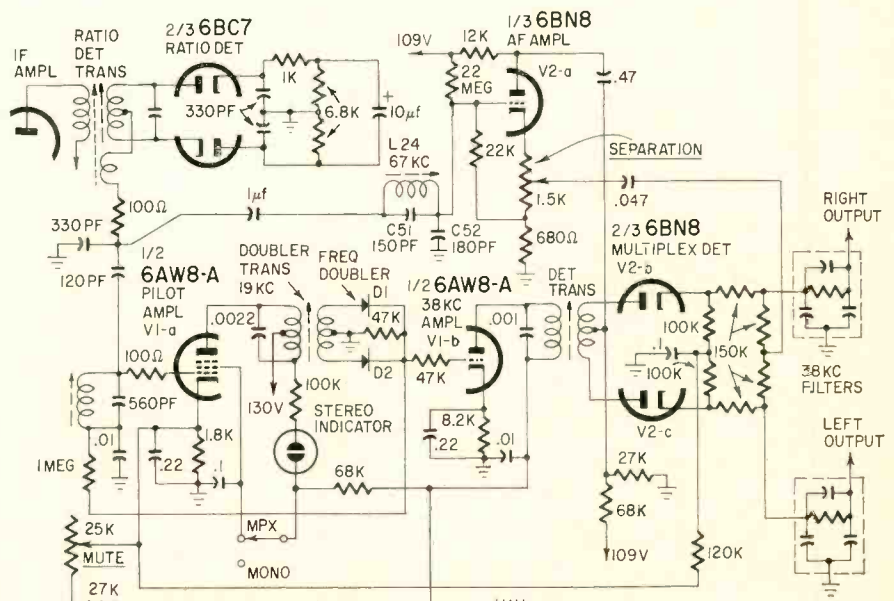

Fig. 2—Circuit of the Zenith 9H21 stereo adapter.

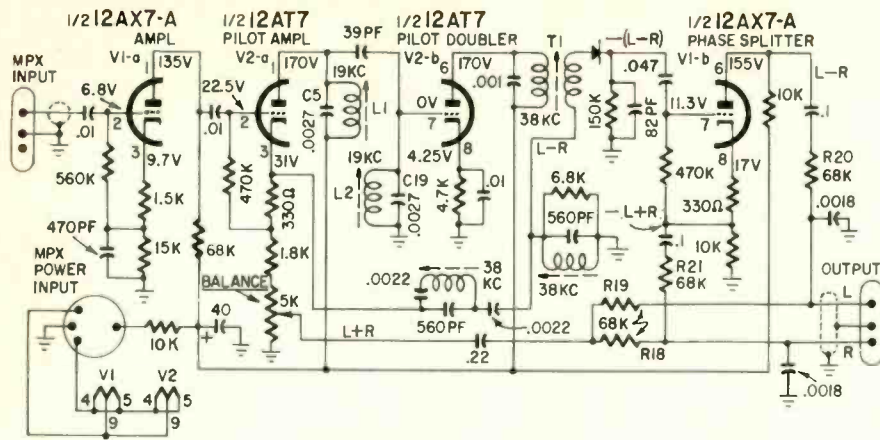

Fig. 3—The RK-295 is RCA's FM stereo adapter.

V2-a and then fed from the plate circuit to the center tap on the multiplex detector transformer.

The L-R sidebands combine with the 38-kc regenerated carrier in the transformer's secondary. The left and right signals are then detected as in the Motorola circuit just discussed.

When the station transmits a monaural signal, the 19-kc pilot amplifier cuts off and there is a slight rise in the dc voltages supplied to various parts of the multiplex circuit. The plates of the multiplex detector (V2-b and V2-c) rise to around 2 volts positive with respect to the cathodes, so the diodes conduct continuously. The L+R voltages at the plates are fed directly to the output terminals and we have the monaural signal on both channels.

In theory, we assume that the L+R, L-R and -(L-R) signals have equal amplitudes so they combine to produce 2R and 2L signals for maximum separation. In practice, separation may not be optimum, because there will be a small amount of residual R signal in the left channel and some L signal in the right channel.

Zenith includes a factory-set separation control that is adjusted as follows: A multiplex generator is set to send an R (right) signal only. An audio voltmeter is connected across the left-channel output and the separation con-

trol is adjusted for a minimum reading. Or, the generator may send a left-channel-only signal and the control be adjusted for minimum output from the right channel.

The RCA multiplex adapter

The RK-295 adapter (Fig. 3), is the simplest we've seen designed for packaged equipment. Composite multiplex stereo from the tuner is amplified by V1-a and V2-a. The 19-kc pilot subcarrier is developed across tuned circuits L1-C5 and L2-C19 and then doubled to 38 kc in the primary of T1 in V2-b's plate circuit.

The L+R audio signal is tapped off the BALANCE control and applied to the resistive matrix network (R18, R19, R20 and R21) across the output terminals. The L-R 38-kc sidebands at V2's cathode are filtered out and fed to T1's secondary. The 38-kc reinserted carrier and the L-R sidebands combine to form a 38-kc AM signal between the top of T1's secondary and ground.

This signal is rectified by the detector and fed to phase splitter V1-b. The L-R signal is taken off the plate and the -(L-R)—or R-L—signal off the cathode. There are combined with the L+R signal at the matrix network to develop 2R and 2L signals at the right and left output jacks.

END

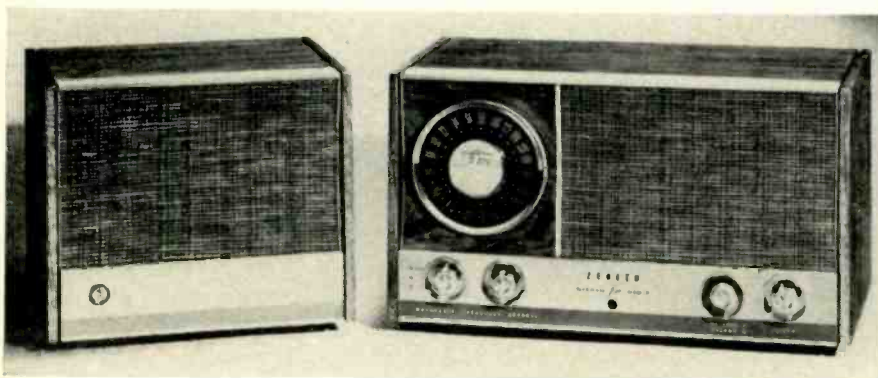

The Zenith "Stereo Symphonair" uses circuitry shown in Fig. 2.

Power-Rectifier Test Substitute

Connect a pair of 500-ma silicon rectifiers in series with pilot lamps as indicated in the circuit. Any lamp that carries 500 ma or more is usable. A pilot lamp can be paralleled with a resistor or another lamp to handle 500 to 750 ma. If two lamps are used, they must both be the same type. When an indicator lights to near full brilliance, approximately the full current is flowing.

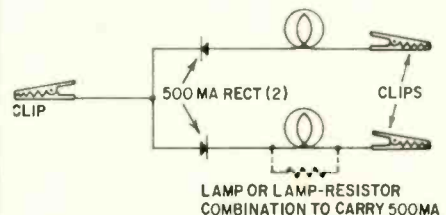

Clipped in parallel with an existing voltage-doubler pair, the brilliance of the lamps shows the condition of the existing rectifiers. If the lamps do not glow equally, the rectifiers under test should be replaced as their current flow is unequal. If the test substitute has unequal brilliance, circuit trouble is indicated.

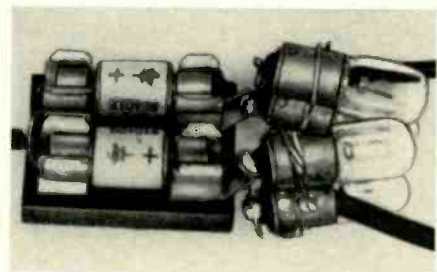

When using this test substitute it is necessary to apply power gradually with a variable transformer or the initial current surge may burn out both indicators.—Carl Remel

Correction

In the photo of the R/C receiver on page 27 of the January issue, the 50- μ h choke (RFC) was mistakenly called L2. L2 is a part of the tuned impedance network labeled Z. C10 is not visible in the photo. It is behind the relay and between V4 and V5.

We thank W. G. Morgan and E. E. Palmer, of Seattle, Wash., for bringing this to our attention.

NIKOLA TESLA

By DEXTER S. BARTLETT

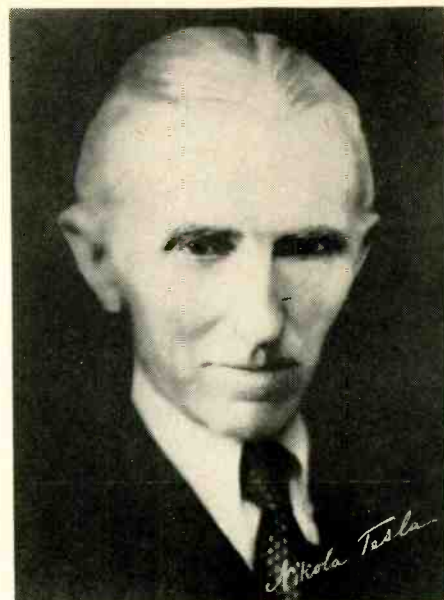

NIKOLA TESLA WAS AN EXTREMELY visionary person—even bordering on the neurotic—who had the uncanny habit of making most of his visions come true. This is attested to by the more than 900 patents to his credit, many of which were fundamental. His other visions were mostly ahead of his time. Like others who have accomplished things, he preferred his workshop to society.

Nikola Tesla was born in Smiljan, Lika, in what is now Yugoslavia, in 1856. He was the son of a clergyman and Georgiana Maudic, herself not unknown as an inventor. After completing his primary education, his parents wanted him to enter the church but he prevailed upon them to send him to the Polytechnic at Gratz. There he studied mathematics for four years, followed by two years of philosophical studies at the University of Prague. He died in New York on Jan. 7, 1943.

He developed his first invention, a telephone repeater, in 1881, and conceived his idea of the rotating magnetic field which was to be the basis of his famous ac transmission of power. He then traveled in France and Germany, and finally settled down in the United States. He was attracted to America by the remarkable progress of the electrical industry, and with 4 cents in his pocket, stepped off the boat at New York City's Battery in 1884. America as a land of opportunity was soon apparent, for as he walked up Broadway he met a group of men trying to repair an electric motor. They paid him for fixing it. He proceeded with high hopes of finding work with Edison. His luck continued; Edison gave him a job in his laboratory at Orange, N.J., designing motors and generators.

After some time with Edison, designing motors and generators, Tesla began to have visions of high-voltage ac transmission lines covering the nation, while Edison still claimed that dc power was the only logical way. So in 1887 Tesla started his Tesla Electric Co. This was not much of a success and he soon sold his patents to Westinghouse for a good sum. His polyphase ac transmission system was the first used

between Niagara Falls and Buffalo—the great granddaddy of all power networks of this day.

Among his many wireless telegraph patents are a rotary spark gap; a coherer in which filings were placed in a chamber exhausted of air, decohered by revolving it constantly; a tiker or loose contact detector; filamentless lamps or neonlike tubes, and suggestions for the instigation of the first time ticks from the Eiffel Tower, made by General Ferrie in 1909.

In 1891, he showed that it was possible to transmit energy through a single wire, without return. In the same year he invented his justly famous Tesla transformer (Tesla coil) which demonstrated the effects and phenomena connected with high-frequency oscillators. Although this transformer has remained mostly a scientific toy, it is still used to demonstrate rf action.

But his giant intellect went much further. It was he who was the first to transmit wireless power—not just signals—over a distance in his historic experiments in Colorado in the early 1890's, which caused a world-wide furor. In 1890 he also built a huge Tesla oscillator which produced 12,000,000 volts at 100 kc. The primary used over 300 kw. Lightning in huge sparks was thrown as far as 22 feet and created such powerful electrical disturbances in the surrounding earth that 1-inch sparks could be drawn from grounded metal plates 300 feet distant. A little later Tesla was able to obtain lightninglike discharges over 100 feet long. Then, in 1898, at Colorado Springs, he succeeded in lighting lamps at a distance of over ½ mile without wires.

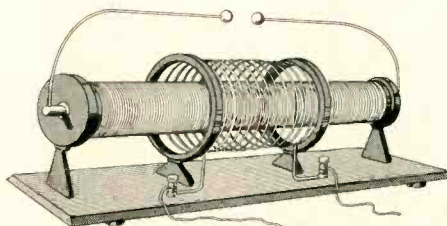

The Tesla coil, source of extremely high voltage

In an 1893 lecture before the Franklin Institute and Electric Light Association, Tesla suggested the possibility of wireless telegraphy and the distribution of electrical energy by stationary waves on the surface of the earth, using the entire globe as a conductor. Here we see the first modern radio diagram, identical with fundamental radio and TV circuits today.

In this age of guided missiles, we should never forget that Tesla again was first when he invented and demonstrated his radio-controlled submarine in 1898. He even constructed large-scale operating models. The vessel, which could take the form of a guided torpedo or of other mobile bodies, was steered and controlled by wireless. It was probably the earliest telemechanical radio-controlled model in existence.

Tesla had, before Poulsen, clearly described the use of a direct-current arc burning in the flame of an alcohol-fed lamp for wireless telegraph CW transmission. In conjunction with John Stone Stone, Tesla invented a 4-circuit tuner and received a patent on Feb. 2, 1902, a year before Marconi's.

Dr. Lee de Forest stated that Tesla was his greatest inspiration in the early days. He once applied for a job, but Tesla had visions of de Forest going on to greater things and turned him down. His vision was soon vindicated. END

References

- Radio-Electronics, June 1956
- Radio-Craft, Feb. 1943 (several articles)
- G. G. Blake, *History of Radio T. & T.*, 1928
- Lee deForest, *Father of Radio*, 1950
- Mary Texanna Loomis, *Radio Theory and Operating*, 1926
- Orrin E. Dunlap, *Radio's 100 Men of Science*, 1944
- J. J. Fahie, *History of Wireless Telegraphy*, 1902
- Donald McNicol, *Radio's Conquest of Space*, 1946
- Scientific American*, Feb. 23, 1901

**GOOD
LITTLE
INDIAN**

the Mohican



10-transistor multi-band portable all-wave receiver that's better than just good

By JOHN T. FRYE, W9EGV

EXPERIENCED TECHNICIANS ARE NOTORIOUSLY blasé about equipment in their respective fields. The auto mechanic takes a jaundiced view of most cars; radio and TV technicians seldom get excited about a new receiver. Now and then, however, a piece of electronic equipment comes along that wins the grudging admiration of even the most seasoned technician. The Heathkit Mohican all-band transistorized receiver (kit or wired) merits such approval on at least three counts: its clever, unusual circuit features; its excellent performance; its fulfilling of a definite need.

Using 10 transistors and 7 diodes, this receiver tunes 550 kc to 32 mc in 5 bands. Only 10 μv of signal on the broadcast band or 2 μv on other bands produce a 10-db or better signal-to-noise ratio. Selectivity is 3 kc wide at 6 db down. The receiver puts out 400 mw of audio at 10% distortion. It is powered by either eight type-C flashlight cells, which give up to 400 hours of normal service, or by an optional ac power supply that can be plugged in in place of the batteries. It has such communications receiver features as continuous bandspread, bfo, rf gain control, signal-strength meter, avc switch, automatic noise limiter, antenna tuning, phone jack and receiver muting terminals. It measures $6\frac{7}{8} \times 10 \times 12$ inches, weighs 17 pounds, and sports a telescoping antenna that extends to 50 inches high.

Interesting circuit features

Probably the first thing you'll notice in the circuit diagram is that three-

terminal devices labeled "404-40" are used between i.f. transistors V4, V5, and V6 instead of conventional transformers. These are Transfilters. Details of how they operate are found in the October 1962 issue of RADIO-ELECTRONICS. They are ceramic devices that perform much like crystal lattice filters. They pass only a narrow band of frequencies to which they are permanently resonated, with a long-term stability of 0.1% for every 10 years of service. Their medium input impedance and low output impedance make them ideal for use with transistors.

404-41's are similar two-terminal ceramic devices that act as resonant bypasses with about 15 ohms of reactance at 455 kc. A single Transfilter stage using these bypasses is claimed to be equivalent to three conventional i.f. transformers.

Since the Mohican uses two Transfilter stages with i.f. transformers at the input and output of the i.f. strip, it is easy to see where it gets its excellent selectivity and the good shape factor of its i.f. system—qualities it will retain for years without need for realignment.

The bfo pitch control is actually R47, a potentiometer! Notice it varies the amount of reverse bias applied to the variable voltage diode, which is effectively in parallel with C62, a part of the frequency-determining capacitance of the bfo. When reverse bias is applied to a diode, the electrons go to the positive terminal and the holes to the negative terminal, leaving a depletion area near the junction. The more voltage ap-

plied, the wider this depletion area becomes. Here we have the equivalent of a variable capacitor—two conducting "plates" separated by a variable amount of nonconducting dielectric. This capacitance effect of a reverse-biased diode is put to work to vary the frequency of the bfo through the i.f. pass-band.

But consider this: the collector-to-base junction of a transistor is actually a back-biased diode and undergoes the same change in capacitance with a change in applied voltage. This effect, put to good use in varying the bfo frequency, is a great nuisance in high-frequency transistor circuits, for the change in capacitance with voltage variation produced by aging batteries or avc action causes serious detuning of such circuits.

The cure is a Zener. This particular Zener has a breakdown potential of 6.8 volts, and current is fed to it through current-limiting resistor R51. The combination makes a very effective voltage regulator circuit. The voltage appearing across the diode is fed to the rf amplifier, mixer, local oscillator and bfo and is maintained at very nearly 6.8 volts in spite of wide variations in supply voltage and considerable changes in current demands of these transistors.

The output circuit also has some unique features. Transistors V8 and V9 are operated in a modified push-pull class-B circuit that employs no output transformer. The 35-ohm speaker voice coil is driven alternately from V8's emitter and V9's collector. There is

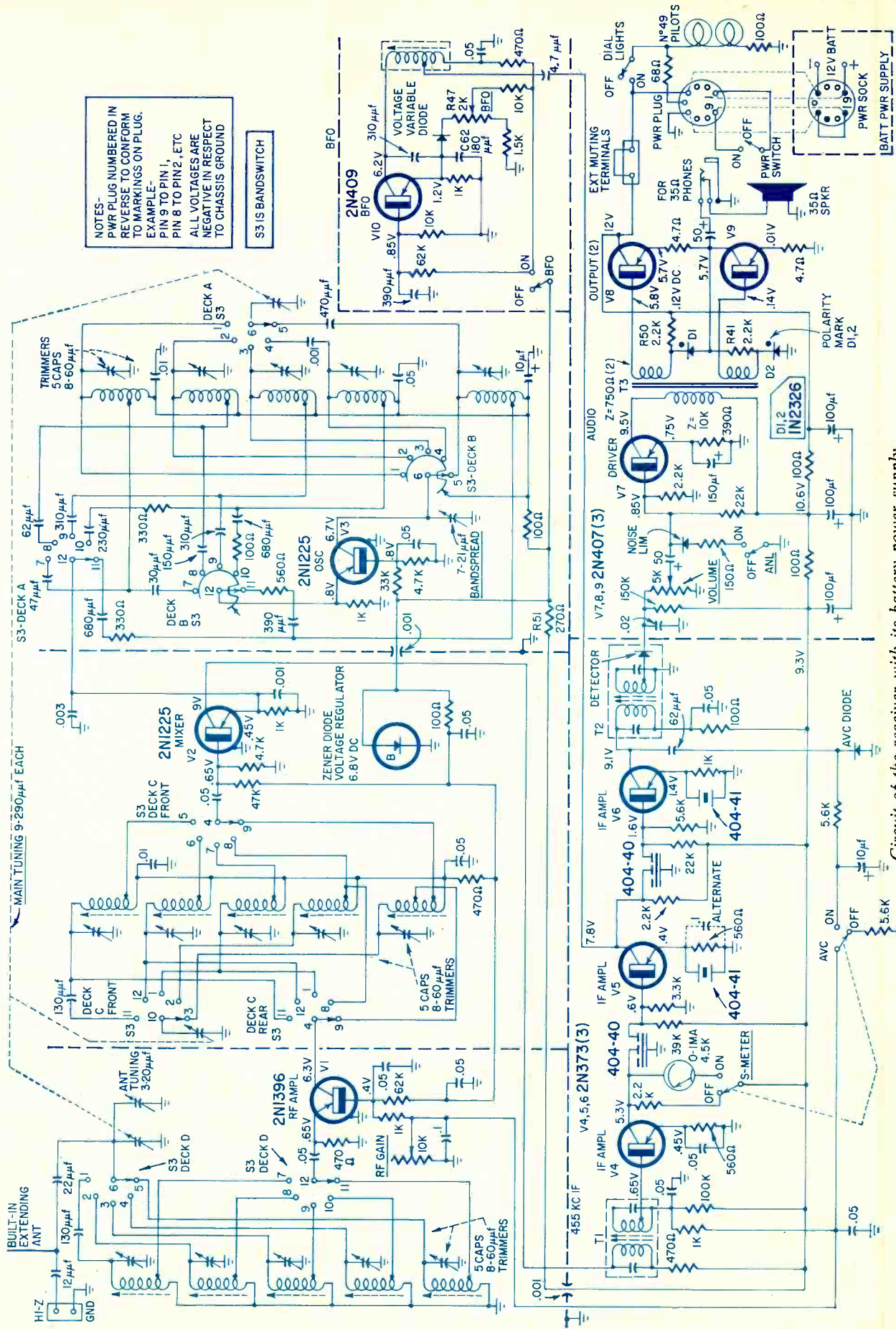

NOTES-
PWR PLUG NUMBERED IN REVERSE TO CONFORM TO MARKINGS ON PLUG.
EXAMPLE-
PIN 9 TO PIN 1,
PIN 8 TO PIN 2, ETC
ALL VOLTAGES ARE NEGATIVE IN RESPECT TO CHASSIS GROUND
S3 IS BANDSWITCH

Circuit of the receiver with its battery power supply.

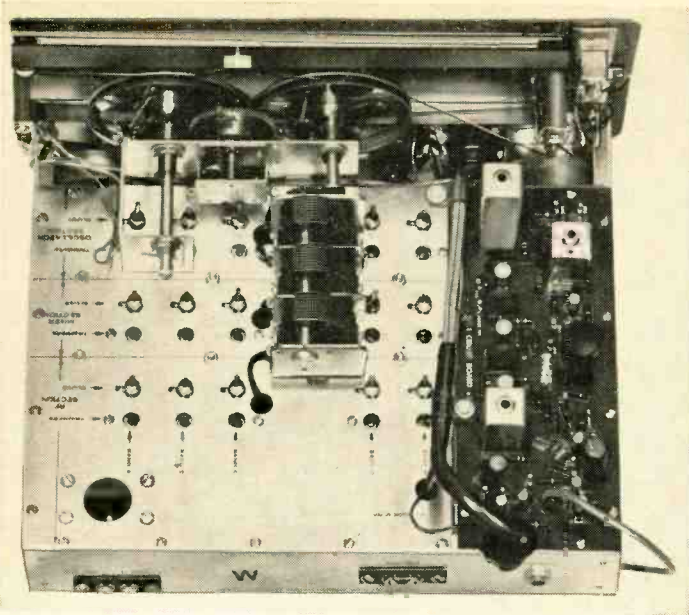

A look
under
the hood.

—12 volts on V8's collector, but the voltage-divider network consisting of R41, R50, and the two 1N2326 compensating diodes places —6 volts on the base, leaving a 6-volt difference between the emitter and collector. V9 has —6 volts on the collector, and the emitter is practically grounded; so the two transistors run at the same voltage level.

The compensating diodes do two things: First, they act as nonlinear voltage regulators to maintain proper cutoff condition in the class-B stage in spite of changes in battery voltage. Second, they have a negative temperature coefficient that effectively compensates for the positive temperature coefficient of the output transistors and prevents excessive battery drain and poor quality at high temperatures.

There are other interesting features. Notice when batteries are in use the dial lamps do not light until the spring-loaded dial-lamp switch is pushed to the right. This lamp switch doubles as a battery condition indicator, for the extra load of the lamps will cause an appreciable drop in the voltage output of nearly spent batteries—a drop too great for the Zener diode to control. If switching on the lamps causes a marked change in the tuning of the receiver on one of the higher frequency bands, you need new batteries! When the ac power supply is used, the lamps are automatically connected across the supply as a stabilizing bleeder resistor and are on all the time.

The receiver even has a built-in transistor tester. Any transistor in the set can be tested in the V4 socket which has an S-meter in its collector circuit and an rf gain control to vary its base bias. If varying this control from one extreme to the other causes the meter to change by at least half-scale, the transistor in the socket may be assumed to be good.

Assembly

This is not a kit you want to, or can, put together in a couple of evenings. I have assembled many kits, including the Mohawk receiver, Apache transmitter and SB-10 SSB adapter, yet it took me a full 40 hours to assemble the GC-1A, align it and put together the ac power supply. The receiver's i.f., af and bfo circuits are on a printed-circuit board, while the rf, mixer and local oscillator circuits are hand-wired.

For those who look askance at printed circuits—often with reason—let me assure them this is a *good* printed circuit. The board is heavy, with clean circuitry well bonded to one side only. No weighty, board-flexing parts are mounted on it, and the board is rigidly supported on the main chassis by bolts around the entire perimeter. Mounting parts on the board presents no problems if the detailed instructions are followed carefully.

The critical front-end wiring is where it would be easy to goof. First, you mount all 15 slug-tuned coils and 15 trimmers on the bottom of the main chassis plate and do all possible wiring to these components. Wire lengths are specified down to $\frac{1}{8}$ inch.

Next you mount the rf and mixer transistor sockets on one subchassis and the oscillator socket on another. Now you take apart the four-deck band-change switch and reassemble it with the two subchassis properly spaced between the decks. Finally you bolt this whole subassembly to the main plate and solder all loose wire leads coming from the coils, sockets, etc. to the switch connections. When the finished receiver is slid into its metal cabinet, each high-frequency stage is fully shielded in its own compartment.

Points to watch

Check that reassembled band-

change switch very carefully to make sure you have each wafer properly positioned and oriented before you start connecting wires to them. It would be very easy to have one wrong, and those switch connections will not stand much unsoldering and resoldering! Follow instructions regarding lead length and lead dress exactly. Both are very important to the high frequencies handled by these circuits.

Take enough time and care to insure that both the main tuning and bandspread pointers slide freely and smoothly. This takes a little doing, but it pays off big dividends in satisfaction later.

I suggest you place the receiver on a metal cookie sheet when aligning. The sheet will "stand in" for the metal bottom of the receiver cabinet. This will make things a bit easier as this metal does have some effect on alignment, especially on the higher frequencies. In aligning and checking the image frequencies, remember that the oscillator works on the high side of the signal on bands A, B, C and D, *but it is on the low side on band E*. This is easily overlooked in a rush to complete the job.

Finally, keep in mind that the slugs and trimmers of each coil interact, and you have to keep going back and forth from one end of the band to the other, adjusting the three slugs at one end and the three trimmers at the other until you can no longer get any improvement *at either end of the band*. Admittedly, this takes time and patience, but doing the aligning job right will spell the difference between a mediocre receiver and a really "hot" GC-1A.

Performance

Candidly, I did not expect too much from the Mohican. My station receiver, the Mohawk (see *RADIO-ELECTRONICS*, December 1958) is a specialized communications receiver tuning only the ham bands. I wanted something with which I could hear WWV transmissions, listen for out-of-the-band harmonics, and copy a few of the stronger broadcast and commercial short wave stations. In short, I wanted a second receiver that would let me see the "big-picture" of the short-wave spectrum, even though dimly, in addition to the powerful, fixed-position, narrow-field "shortwave telescopes" I already had. Experience in my service shop with many so-called multi-band transistor radios had conditioned me not to expect much on the higher frequencies.

But when I placed the Mohican atop the Mohawk and started comparing reception, I was astonished at how sensitive the GC-1A was on the 10-, 15- and 20-meter bands. I found stations on each of them that would nearly "pin" the S-meter. Undoubtedly the use of 100-mc cutoff drift transistors in the

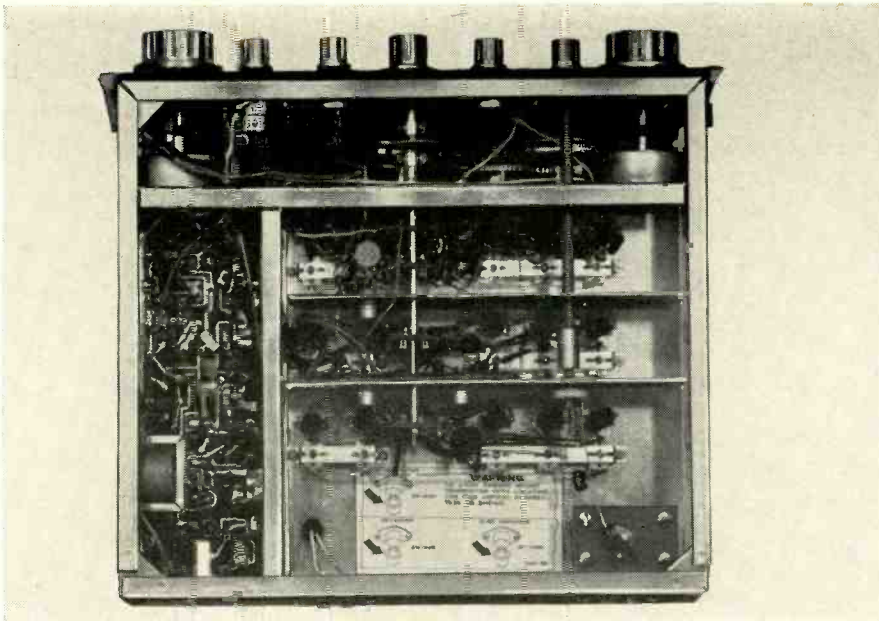

Underchassis view shows receiver sections are shielded from each other

front end accounts for that 2- μ v sensitivity, and in most receiving locations it takes a good ear to detect a difference between 2- μ v and 1- μ v sensitivity.

Selectivity was all it was claimed to be. I live about halfway between WLW on 700 kc and WGN on 720 kc, both running 50,000 watts. With the ordinary broadcast receiver you would never suspect there was another station between these giants. With the Mohican, however, I can pull in WOR on 710 kc at night without interference.

Encouraged by these experiences, I put a relay on the muting terminals, connected the external antenna leads to my change-over relay, and started calling CQ. I had satisfactory AM, CW and SSB contacts on all bands, 10 through 80 meters. Next, I used the Mohican as my receiver while acting as net control

station for our 75-meter state traffic net into which both AM and SSB stations check—truly an acid test! I missed my product detector on SSB reception, for the rf gain control had to be backed off until the bfo could insert sufficient carrier, but I managed without too much difficulty. Incidentally, that rf gain control is needed, for many signals come in so powerfully they overload the front end if it is running wide open.

Drift presented no problem. There is some shift in frequency with a change in ambient temperature, but this is a long-term affair having nothing to do with how long the receiver has been on.

I tried the built-in telescoping antenna, a long wire, my all-band trap antenna fed with 72-ohm transmitting type ribbon and my TH-4 tri-bander beam fed with RG-8/U. Naturally re-

ception with the 50-inch whip is not as good as with the more efficient types, especially on the lower frequencies, but it is surprisingly good. I was happily astonished to find the receiver worked very well when its high-impedance antenna terminals were connected to my low-impedance transmitting feedlines. When I used balun coils to provide better theoretical match, the improvement could not be detected on the S-meter.

I hesitate to recommend the Mohican as an *only* fixed station receiver. Under present-day crowded band conditions and the growing accent on SSB, the station receiver needs a product detector, variable selectivity, a notch filter and lots of handsbread. The handsbread tuning on the Mohican varies only the oscillator. When the handsbread pointer is moved from the set position, the oscillator can be followed with the rf stage by manipulating the antenna tuning, but the mixer stays put. For wide excursions of the handsbread pointer, this results in impaired selectivity and sensitivity. I like to leave the handsbread pointer near the set mark and do my tuning with the slow-ratio main tuning knob. The handsbread knob is used as a fine-tuning control. This retains the excellent sensitivity and selectivity of the GC-1A.

Where the Mohican really shines is as a deluxe receiver for the serious SWL and as a second, backup receiver for the ham station. The SWL fan has, in the Mohican, a receiver with portability, sensitivity, selectivity and versatility far beyond most receivers used for this purpose. With it, he is divorced from noisy power lines, he can try a wide variety of antennas, and he can receive all modes of transmission. Using only the whip antenna, I have picked up SW broadcast stations from every corner of the globe. END

Replacing the Irreplaceable Switch

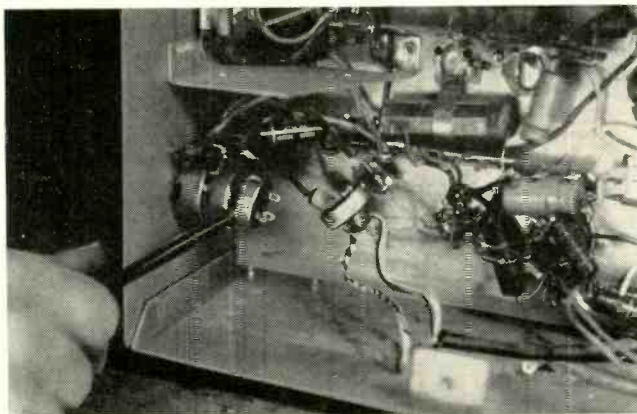

Switches mounted on potentiometers and auto radio pushbutton assemblies pose a definite replacement problem. When exact replacements are not available, switch failure often necessitates replacing the whole assembly. But the cost of a replacement and the delays in getting it can lose a customer.

There is a way around this:

Insert the blade of a screwdriver between the switch and the body of the control. Twist the blade until the retaining lugs straighten. Remove the switch. Take a new switch section and clip the retaining lugs on its body to $\frac{1}{32}$ inch. This keeps them from

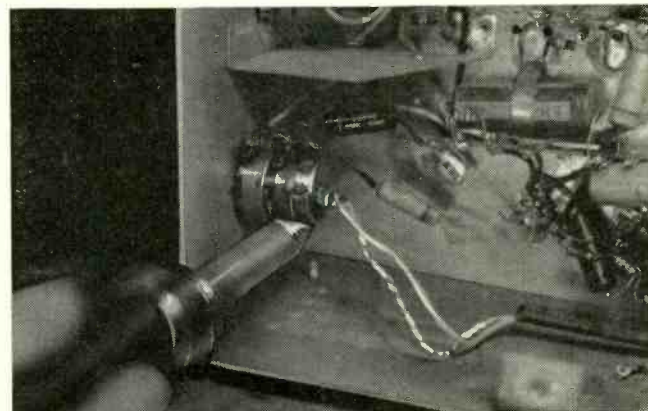

extending into the body of the pot and interfering with the moving parts. Position the new switch in the old mounting holes and make sure the trip arm on the control rotor actuates it properly. Solder the switch in place at two or three points and reconnect it. The photos show this being done.

HOLE

Hole—an open place. But making one in steel or concrete or wood isn't exactly simple

By JACK DARR

SERVICE EDITOR

The title of this article might be misleading. Let's straighten this out right now: the holes I'm referring to aren't the kind that wander around in transistors, or that go "Now you see 'em—now you don't" in tunnel diodes, or even the ones in the writer's head. The holes in this article are the plain old-fashioned kind you have to make in TV chassis to hold things.

Cutting such holes is a job the service technician often runs into. I thought it might be a good idea to run over some of the ways of making them.

Where to make the hole is determined by the part you're mounting. Mark the spot with a soft pencil. Then use a center-punch to make a wee pit to keep the drill from scooting off into nearby parts (Fig. 1). Set the chassis solidly on something that will take the impact of the punch. A good trick here, if you can do it, is to use a backing block of metal. It can be any kind of piece of solid metal. Fig. 2 shows one useful type. It's a short piece of metal shaft with two parallel flats ground on one end. Shove this end in a vise and place the other end below the place you want to hit.

Drills and bits

There's some confusion about the

terms drill and bit. They are often used interchangeably. In this article, the bit is the part that does the cutting. The drill is the part that holds the bit.

The standard twist-drill bit has two spiral flutes on its stem to clear the chips. The tip of the bit is ground so the two cutting edges take off thin chips of metal as they revolve (Fig. 3). These edges must be sharp. Standard bits turn clockwise, looking down on the work.

Dull bits are standard equipment around the shop. However, they aren't hard to sharpen if you use just the right twist of the wrist. You'll need a smooth, fine-grit grinder. One very important point is the angle of the cutting edges. For sheet-metal work, and this makes up most of our jobs and most of yours, it ought to be about 85° to 90° (Fig. 4).

To sharpen a bit right, you've got to hold it very steady. There's a special holder for this purpose, but you can do it by hand, using the tool rest on the grinder (Fig. 5). Hold the tip against the wheel, taking only a very small bite each time. Keep a glass of water handy and dunk the tip in it each time you stop. Never let the tip get too hot. This takes the temper out of the steel and the bit will become dull again very quickly.

Touch one face then the other against the wheel. The angle at which the bit

is held determines the final tip angle. Be sure to keep the two faces equal (Fig. 6) and flat. Never turn the bit while grinding. The faces, in Fig. 6, must be equal in area and perfectly flat.

Drilling plastics

For drilling plastics, you can get better results with a flatter angle on the bit. Most plastics tend to melt under the heat generated by the spinning bit, clogging the hole. Drill very slowly. One trick used in drilling thin sheet plastic is to sandwich it between scraps of Masonite, clamping tightly and drilling through all three at once. Even then, take it slow and easy for the neatest results.

Electric hand drills

The most popular size electric hand drill for TV shop work is one with a ¼-inch chuck. There is only one right way to make holes with a hand drill. Hold the drill firmly in both hands as in Fig. 7. Note the knuckle extended below the left hand resting on the top of the if transformer can. It keeps the bit from plunging on through the sheet-metal chassis and wrecking numerous delicate components underneath.

When drilling sheet metal, you'll soon learn to recognize the change in pitch of the sound when the drill is just about



Wood bit in chuck of electric drill. This is not the type bit used with a hand brace.



Fly-cutter being used to cut 1-inch hole in car fender for mounting auto-radio antenna.

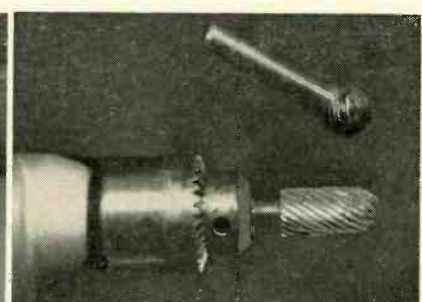

Small burr and electric drill make job easier in tight places.

Fig. 1—Use a center punch to make a small pit in sheet metal. This holds the point of the bit until it gets started and you put the hole right where you want it.

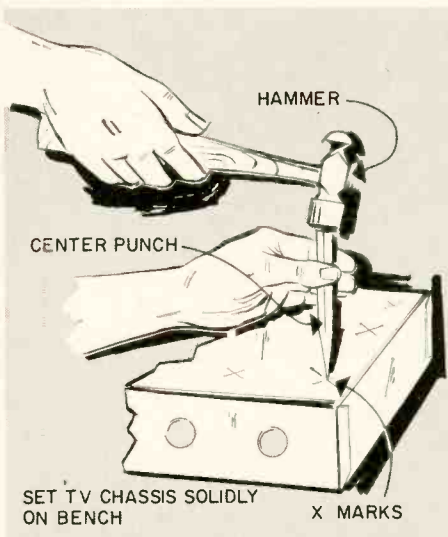

Fig. 3—Typical twist drill bit.

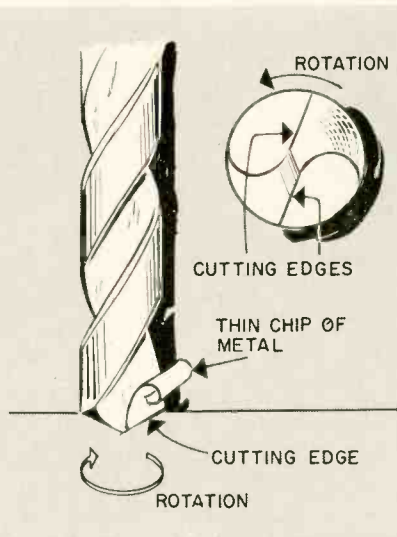

Fig. 5—Always use the tool rest when holding the bit against the grinder. No one can hand-hold a bit steady enough to get the proper angle. Never turn the bit while grinding. Both tip faces must be flat.

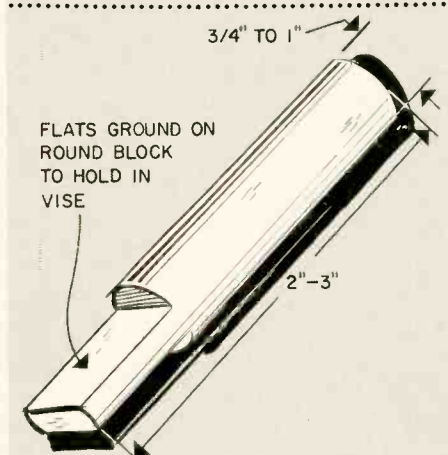
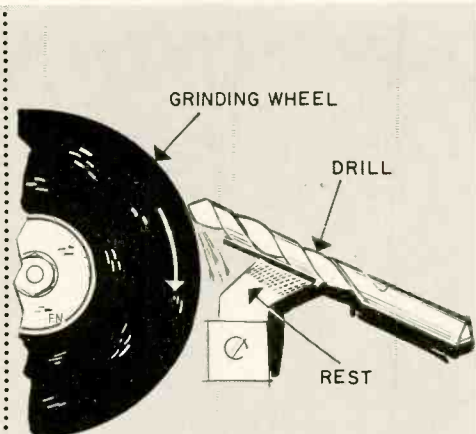

Fig. 2—This handy backing block can be made from a short piece of round metal shaft. Grind two flats on one end so it can be held in a vise.

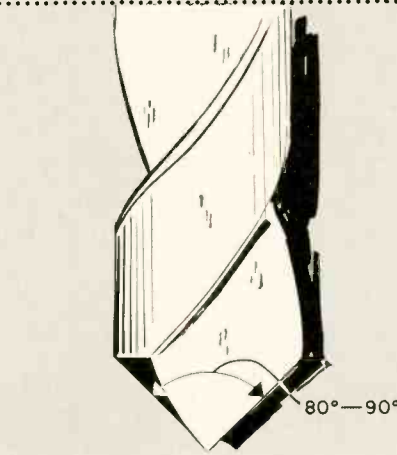

Fig. 4—Correct angle of cutting edges gives best results.

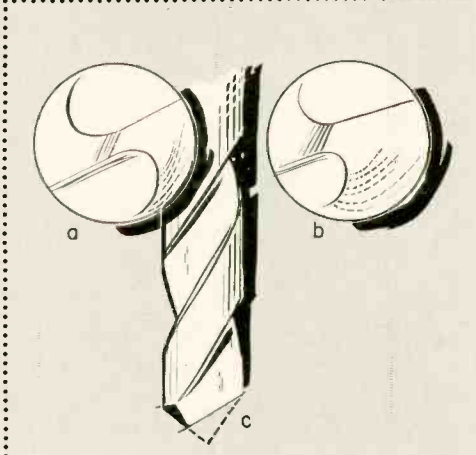
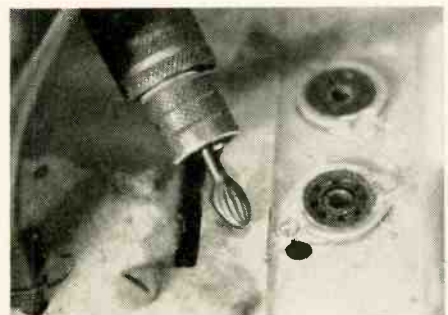

Fig. 6—A twist bit that is properly ground (a) and improperly ground (b). Side view of the improperly ground bit (c) shows how the tip is off-center and the angles are unequal.

ready to go all the way through. When you hear that, get ready to catch the weight of the drill to keep it from going too far. By the way, this should have been mentioned first, but *always check the chassis under any hole you're thinking of drilling! See what's under there*

that could be damaged. If you must drill a hole where parts below might be damaged, make a temporary depth gauge by wrapping tape tightly around the bit stem at the proper place (Fig. 8). While it won't stop the drill entirely, it will slow it up enough to let you gain

control. When drilling holes in thick metal, use lubricating oil on the tip of the bit to reduce friction and speed cutting. As a further aid, use a small bit first, then change to the final size of bit needed. This is particularly important when



Rotary files are ideal for enlarging holes cut in sheet metal.

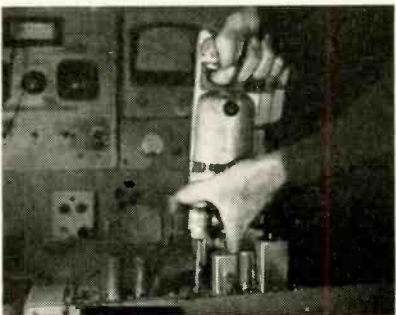

Fig. 7—The correct way of holding an electric drill.

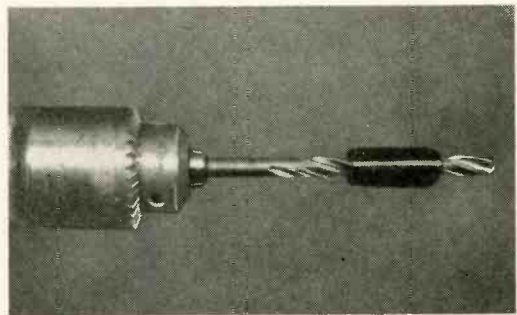

Fig. 8—Temporary depth gage is made by wrapping tape around bit.

the final bit is $\frac{1}{4}$ inch or larger.

Drilling out rivets

Lots of components are riveted in modern chassis. Removing the rivets can be a tough job sometimes. One way is to center-punch the head of the rivet and drill it out (Fig. 9-a). This is all right, but it has its drawbacks. A rivet will often come loose and simply spin instead of sitting tight and being drilled out. The easiest way in the long run is to use a small burr or rotary file (Fig. 9-b). For very tiny rivets a miniature burr is better. They can be used in a $\frac{1}{4}$ -inch drill. For even better results in tight places, use one of the small electric drills known as a hand grinder.

For larger rivets, and also for finishing holes which must be made

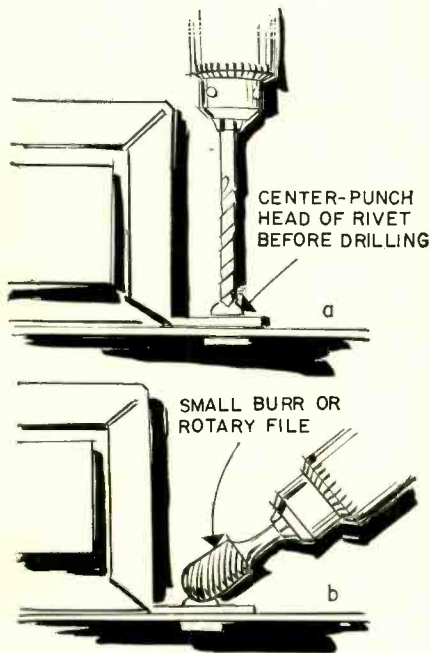

Fig. 9—A small burr is often better than a bit for removing rivets.

slightly larger, the $\frac{1}{4}$ -inch shank rotary files are very handy. They have many other uses, which you'll discover as you go along. (Cleaning rust, paint, etc.)

Small holes

Once in a while you'll have to drill a very small hole. This can be done with a hand drill if you're very careful. Be sure to keep the pressure off the bit as much as possible. Let the weight of the drill take it into the metal. Hold the drill very straight, so that there is no side pressure on the bit. That breaks small bits immediately.

Special tools

You can make holes up to 2 inches in diameter with a $\frac{1}{4}$ -inch drill and the right accessories. You can use either flycutters or holesaws. The fly-cutter gets its name from the fact that the cutter bar, the small diagonal bar seen at an angle across the shank, cuts as it "flies" around the circle. (The same action is found in a lathe.) The holesaw is a circular hacksaw (Fig. 10).

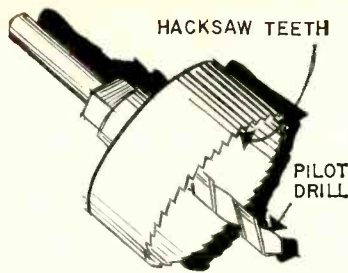

Fig. 10—Holesaw made for use with an electric drill. They are made in a variety of sizes.

Each of these tools uses a $\frac{1}{4}$ -inch pilot bit. It makes the starting hole and holds the cutting tool steady after it has penetrated the surface. When using either of these tools, be sure to keep a very tight grip on the drill and feed the cutter into the work *very* slowly. Watch out for the moment when the cutter goes through the work. Both tools have a tendency to "whip" at this point. Be prepared to cut the power instantly and keep the tool from running wild.

Wood boring bits

Boring holes in wooden walls, making neat holes in phonograph mounting boards and jobs like those have always been a headache for the TV technician. But a set of *electric-drill wood bits* can make things much easier. The bits are actually just flat metal shapings in a special holder, which in turn is chucked in the drill. A nut is tightened to hold them in place. These will cut very smooth holes in any kind of wood, in a fraction of the time needed to make a similar hole with a brace and bit. They're real handy for boring through wooden walls when installing TV lead-ins, intercoms, etc.

Chassis punches

About the final classification would be what I have always called shear punches or chassis punches. These are made in two sections, the anvil and the shear (Fig. 11). In use, a pilot hole is drilled at the center of the larger hole, the punch separated, the bolt passed through the hole, and the shear screwed on it. As the bolt is tightened the two parts are drawn together.

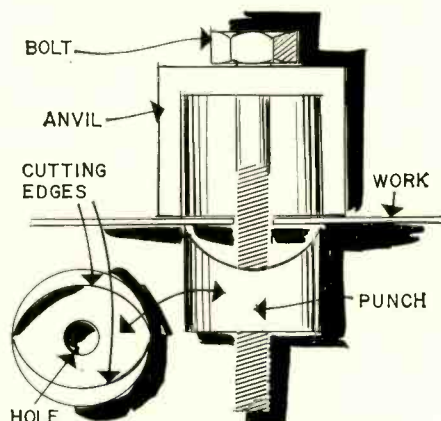

Fig. 11—Chassis punch uses a threaded bolt to pull the punch through the metal to be cut.

The shear has two lips which penetrate the surface of the sheet metal. The anvil is made so that the shear will just slip inside it. When the bolt draws the two halves together, a very neat round hole is punched. They are also made in square, D and keyed types, for making almost any kind of hole needed.

Such punches are much used to make holes for tube sockets and other components in radio and TV work. In two-way radio work, the $\frac{1}{4}$ -inch hole needed for installing a mobile whip antenna can be made very easily with one of these.

Another type of shear punch is shown in Fig. 12. It is actually a set of punches. Matching shears and anvils are selected, placed into the pilot hole and hit with a hammer.

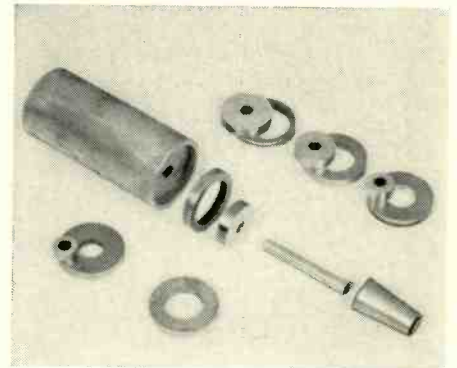
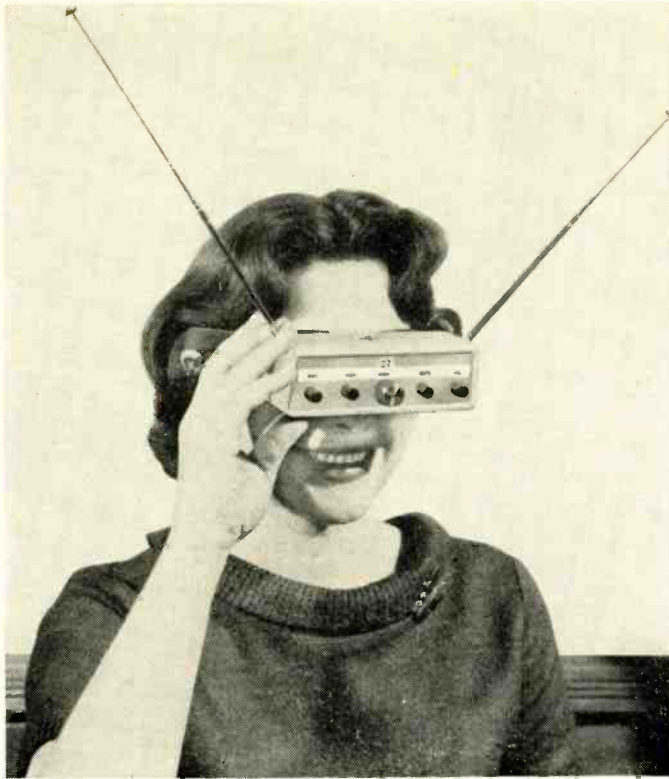

Fig. 12—This chassis punch is hit with a hammer to make chassis holes. It comes with a variety of punches in different sizes.

Masonry bits

Another place the electric drill is handy is with masonry bits. Any antenna technician who has ever spent a miserable afternoon hanging on a ladder while he tried to make holes in a brick or masonry wall with a star drill and hammer will certainly appreciate these. They look just like ordinary drills, but usually have special silicon carbide tips to withstand the terrible punishment of grinding through stone, mortar and bricks. They come in several sizes from $\frac{1}{4}$ inch on up to $\frac{1}{2}$, $\frac{3}{8}$ and so on. While the tips are extremely tough, they can be resharpened by a machine shop with a diamond wheel, used to resharpen lathe tools.

Masonry bits should not be used in a standard $\frac{1}{4}$ -inch drill. These drills rotate too fast for them and will reduce their life. They should be used with a slow-speed $\frac{3}{8}$ - or $\frac{1}{2}$ -inch drill. If you must use a high-speed drill, apply minimum pressure to prolong the life of the bit. When using these bits, be sure to hold the drill perpendicular to the surface you are cutting the hole in. If this is not followed, the silicon carbide tip will wear rapidly and form a bevel on the cutting edge, making it necessary to resharpen the bit before it can be used again. This can happen in a very few minutes, so be extremely careful. END



TELEYEGGLASSES

Worn like spectacles, this set is ready for stereophonic, stereoscopic TV.

By **MOHAMMED ULYSSES FIPS, I.R.E.***

THE IDEA OF TELEVISION EYEGGLASSES IS by no means new. In the October 1936 issue of *Short Wave Craft Magazine*, its editor said:

"... You will use a tiny television receiver placed right on your very nose—a device which I term 'television eyeglasses.' These will be regulation eyeglasses, but instead of having the normal lenses, they will have a small projection of one or two inches which will house the entire television receiver. There will be two such receivers (sound and picture) working in unison."

That was 27 years ago. BT (Before Television) and Before Transistors, when microminiaturization was not even a dream. But the idea was sound, although up to now no one has built a self-contained, battery-operated TV-eyeglass receiver. Then, too, who would be silly enough to wear on his nose a set that requires a picture tube with a 12,000-volt supply that could electrocute him?

But I knew I could build such a receiver which, I was well aware, millions of people would buy.

Look at all its advantages: No more family fights about *what* channel to select. Everybody wears his own set on the nose, tunes in to his own program. The set weighs only 6 ounces, has its own antenna, so you can walk anywhere with it, with the sound turned up, yet no sound is heard on the outside because I use bone-conduction audio back of the ears. Moreover, I have calculated that such sets can be marketed for less than \$100 each, and *much less when made in Japan*.

* Institut Recherché Electroniciens (Paris).

I therefore worked feverishly for nearly 2 years, constructed many models in my spare time, and finally succeeded beyond my fondest dreams. This, then, is a complete report of my labors:

1. I use a standard plastic eyeglass frame that has two bone-conduction receivers, now common on many hearing aids. Hence you hear with both eardrums.

2. The set is all transistor, with microminiature transistors so small that you cannot see them except under a microscope. The transistors need no wiring because they are mostly interconnected films electrodeposited under vacuum.

3. While I experimented with microcathode-ray tubes less than 1 inch long, they still were too big! I wanted something better. I finally had constructed for me a flat CRT of the Aiken-Geer type now used in some military applications, 1 inch square and 1/2 inch thick. (For further information see the article, *Flat TV Tube*, by Eric Leslie,

page 43, March 1957 issue of *RADIO-ELECTRONICS*.) This tube scans as well as or better than a standard 1-inch CRT.

4. Keep in mind that the screen of the tube is less than 3/4 inch from the average eyeball. The actual picture (screen) measures 1/2 inch wide by 3/8 inch high. This is sufficient, because its proximity to the eye gives an exceedingly sharp picture. (If you doubt this, get a pair of binoculars and view a landscape 1 mile away.)

5. Because of the small flat picture tube so close to the eye, we don't need high voltage for the CRT—only about 250 volts, at very low current. It is so weak that if you touch its terminals with your bare fingers you cannot even feel it! Hence the Teleyes are super-safe—no problem here!

6. I use eight standard batteries to activate the set. Two standard dime-size "button" mercury batteries go into the audio bone-conductor "forks" that fit behind the ears.

The main current supply of the set

Closer view of Teleyes glasses. Antenna sections telescope for convenience and optimum tuning. Knobs (left to right) are vertical hold, contrast, channel, brightness, volume. Black wheel protruding from side adjusts focus.



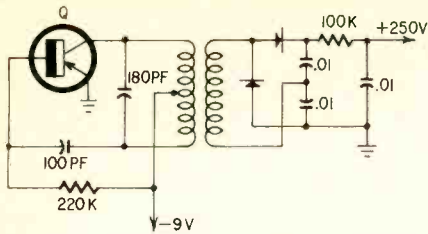

Circuit of hv power supply. Though actual "circuit" uses molecular electronic techniques, standard symbols help show how it works.

is composed of six standard 1.5-volt alkaline batteries (Mallory Mn1500). I constructed a special transistor power supply to boost the 9 volts current to 250 volts for the flat TV tube. (See circuit diagram.) The circuit itself is almost standard TV.

7. The channel selector, on-off switch, brightness control, vertical and horizontal controls, etc., are all standard except for their miniature size.

8. This set differs from other TV receivers in that it has two flat TV tubes, both working in parallel, one for each eye, exactly as the two sound channels.

9. The receiver, as you will note, blocks any outside view for the wearer—normally you can see only the two TV screens. If you want to walk around without stumbling, just push the TV eyeglasses up on your forehead. (A later model, not illustrated, has two prisms which allow you to walk about freely

by shifting your eyes—something like bifocal spectacles.) You will also note the two binocularlike wheels which bring the two viewing screens closer or further from your eyes, for proper focusing.

* * *

I had kept this whole project secret from everyone, including my co-workers at the office, on account of the great commercial value of the receiver. There are also patents pending on certain features not disclosed here.

On the big boss' birthday, I walked into his office, intending to unveil my Teleyeglasses to him as a special surprise and birthday present.

Suffering from an old gout, with his leg propped up on the desk, he was not pleasant to contemplate, with his face contorted in pain. It must have been bad, because he was not even smoking his customary 8-inch cigar. Since the Cuban shindig he had been trying to get a good cigar, but the "Netherlands Dutch Havanas are putrid stinkadores, unfit for even a smokestack," he bel-lowed at his cigar dealer, who then made a hasty exit.

He then observed me wearing my TV glasses, pushed up upon my forehead, antennas extended and all.

He looked mighty surprised when I offered him a second set, but I begged him not to switch it on as yet, but first listen to my sales spiel. This he did with his usual scowling "good" grace.

When I came to the Japan-made lower-price feature, he winced audibly, muttering something unintelligible. This I took to be a sudden gout pain of his.

He then put on the set and turned it on. For a while he looked on and listened in silence.

Suddenly he leaped up like a wounded bull, and because of the set on his nose that blocked any outside view, he couldn't see where he was going. That made him stumble. In the process he collided with his sore gouty foot against a chair. The ensuing bellowing was as awesome as it was horrific.

"Fips, you . . . you infernal tink-er-stinker, you have outdone yourself in stupidity. First you want to foist more Japanese junk on us, so we will lose our own bread-and-butter American advertisers. Then you get up this hellish contraption, that blinds a man so he can't even see your moronitwit map to smash it to a pulp!

"Out! Get out—you televisionary buncomb— you should be televised while frying in Hell!"

With that he hurled his own teleyeglasses at me. He missed, but the glasses smashed a big hole in the glass door.

Departing in haste, I just had a glimpse through my own TV eyeglasses of the newscaster sitting before a large leaf calendar, announcing loudly: Today is the first of the month

APRIL 1



Time constant

Suppose you have two 1-megohm resistors and a 1- μ f 50-vdc capacitor. Using a 100-vdc supply voltage, how can you connect these resistors to provide a time constant of 0.5 second, without exceeding the 50-volt rating of the capacitor?—Earl H. Rogers

Series resistor circuit

In the circuit shown, the vtvm reads

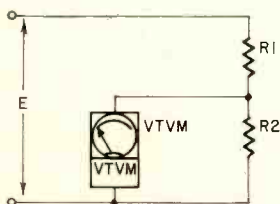

24 volts. A 100-ohm resistor paralleled with R1 raises the voltmeter reading to 40 volts. The same resistor paralleled with R2 reduces the voltmeter reading to 20 volts. What are the ohmages of resistors R1 and R2 and what is voltage E?—L. B. Hedge

A Problem of Resonance

Inductance L and capacitor C form a series-resonant circuit used in a radio command system. The L-C com-

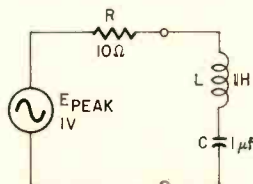

bination is driven by a variable frequency voltage source having a source resistance R and a peak output of 1 volt. What is the minimum permissible capacitor working voltage in such a circuit?—Phil Cutler

How much voltage?

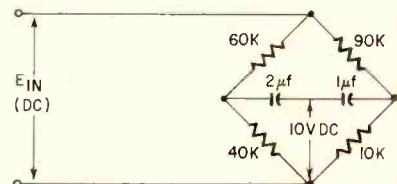

What is the steady-state dc input voltage, E_{in} , in the circuit above?—E. R. Welsh

automated multiplex

When a stereo FM station goes on, your adapter switches in automatically

IF YOU ARE THINKING ABOUT ADDING A multiplex adapter to your hi-fi system, have you figured out where you will put it? It often demands "up front" placement, but have you room for it? Here is a simple, inexpensive, yet effective, solution to the problem—especially if the adapter has a stereo indicator lamp.

To reproduce stereo FM broadcasts, we reinsert the 38-kc subcarrier by a local oscillator synchronized with the received 19-kc pilot frequency. For monaural reception, this signal is not needed or desirable. It can, in fact, be a decided nuisance when listening to monaural broadcasts—especially if the station is also broadcasting SCA store-

push-pull oscillator consisting of both halves of a 12AU7. In addition, the diodes create a negative potential when the 19-kc pilot frequency is received. This negative potential is more than enough to bias the 12AT7 stage to cutoff, raising its plate potential to the full supply voltage. This in turn fires the neon lamp, indicating that stereo is being received.

Changes are simple

Fig. 2 shows the automated circuit. First, the neon lamp is disconnected from the plate of the 12AT7. Then the coil of a sensitive plate relay is made part of the plate load. The total plate-load resistance is reduced to a value

adequate connection. On mono stations (no 19-kc pilot) the unbiased switch tube conducts and the relay is energized, breaking the oscillator circuit. At the same time, if the indicator lamp circuit is included, it is shorted by the normally open contact and extinguished. When a stereo broadcast is received, the 19-kc pilot causes the switch tube to be biased to cutoff, deactivating the relay. This allows the relay armature to drop to its "normal" position, which closes the oscillator cathode circuit (turns it on). At the same time the short is removed from the indicator lamp and it lights.

Continued use of the stereo indicator light is optional since automatic adapter operation lets you place it out

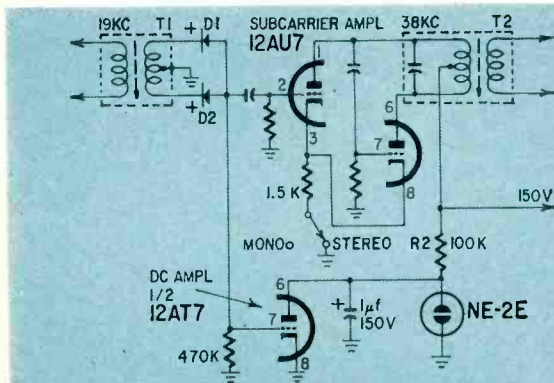

Fig. 1—Partial circuit of the EICO MX-99 stereo adapter.

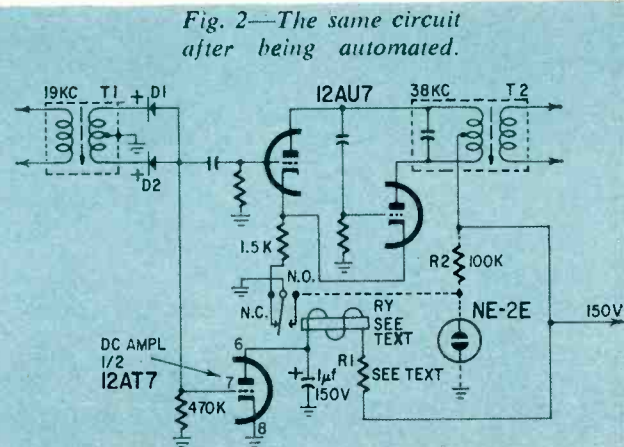

Fig. 2—The same circuit after being automated.

cast on a low subcarrier frequency. This makes the front panel oscillator on-off switch important and prevents placing the unit in an inaccessible position. The separation control is no problem. Once the optimum setting is determined, it seldom requires changing. The power switch is taken care of by simply leaving it "on" and plugging the line cord into a switched outlet on the rear of the tuner or amplifier. So the problem of stashing the adapter behind the scenes and forgetting it boils down to eliminating the oscillator switch.

The 19-kc pilot is a unique feature of the composite FM stereo signal. In some adapters it is used to light a signal lamp. If it does that you can also make it switch on the 38-kc frequency generator!

Fig. 1 is a portion of the EICO MX-99 Autodapter circuit. The isolated and amplified 19-kc pilot frequency is doubled at T1 by the fullwave rectifier consisting of diodes D1 and D2. This 38-kc signal synchronizes the 38-kc

that passes enough current (when the switch tube conducts) to activate the relay. The exact value of R1 depends on the relay selected and the actual supply voltage impressed on the circuit. Suitable relays are the Sigma 11F-9000-G or 41F-10000-S or Potter & Brumfield RS-5D (2.5 ma at 10,000 ohms). I used the Sigma 11F. This relay has 9000 ohms dc resistance and a 2.4-ma pull-in current. With a supply of 135 volts dc, we found 18,000 ohms quite satisfactory for R1. In calculating this resistor, remember that, when there is no 19-kc signal, the negative potential developed by the diodes, due to noise or spurious signals, may still be as much as 0.5 volt or slightly more—so don't count on zero bias for the conducting condition.

The spdt relay contacts replace the manually operated spst switch. The armature of the 11F relay is grounded to the frame and is automatically grounded to the adapter chassis when it is mounted. Use the normally closed (mono) contact for the oscillator cath-

of sight. If you decide you don't need it, leave out the lamp and R2. If you do want it, hook it to the normally open relay contact as shown by the dashed-line circuit. If the adapter power supply uses series resistors instead of a choke in the filter circuit, it may be better to increase R2's resistance and connect the neon lamp circuit to an intermediate point or directly to the rectifier cathode, avoiding an additional voltage drop across the filter resistors. Since the voltage drop across the NE-2E lamp is about 55 volts, R2 should limit current to about 1 ma.

Variations of this circuit may suggest themselves or be required. The essential feature, however, is the use of the 19-kc pilot, which means that it must be amplified to useful levels. Remember that the tube manual states that with a 12AT7 (for instance) the negative grid bias required to reduce the plate current to 10 μ A is -5 volts with 100 volts on the plate, or -12 volts for a plate voltage of 250. END

Improve your TV sound and quality

By DANIEL MARCEK

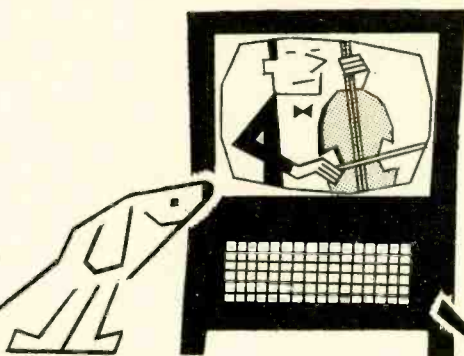

THE PICTURE ON MOST NORMALLY OPERATING TV receivers is good—but is it really *excellent* when you look at it closely? Some detail is missing, sharpness may be lacking, and audio quality is often poor. Why?

The answer is rather simple: Television is a very competitive market and manufacturers must design and build their sets so that they will meet the competition. This means that many ideas cannot be used because they would increase the price of the product and cut the profit margin.

What can the consumer do? One thing is to purchase a custom-designed set. This is too costly for most of us. Therefore, the only answer is to insert a few simple circuits to improve the set we have. I find that adding a few simple ideas (basic and of long standing) to a TV receiver will improve reception and increase more viewing enjoyment.

The first item to be considered is picture focus. Sets that use electrostatic focus have a picture tube with a third (focus) grid. This is usually connected to ground or some fixed B-plus supply point. As a result, optimum focus is not possible and, as various parameters change with age and operating conditions, the picture cannot be refocused easily.

But there is a solution. Disconnect the focus grid lead (Fig. 1). Mount a 2-megohm 2-watt linear potentiometer on

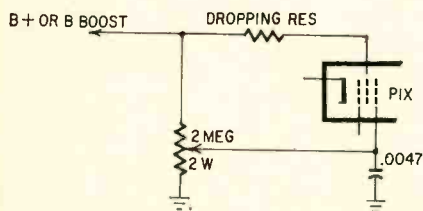

Fig. 1—Electrostatic focus control calls for adding one pot and one capacitor.

the chassis, preferably along the back apron with the other service controls. Now reconnect the focus grid lead to the wiper (center lug) of the potentiometer. Connect one of the other lugs to ground, and the third lug to the end of the dropping resistor away from the accelerating grid (second grid). This resistor may be connected to B-plus or B-boost. Also, insert a .0047- μ f capacitor from the focus grid to ground to stabilize power supply regulation. The voltage rating of this capacitor should be great enough to withstand the highest potential at the end of the accelerating-grid dropping resistor. Now simply rotate the pot to set best focus.

Dc restoration

The next item, one which can greatly improve the video, is adding dc restoration. This circuit was done away with several years ago when one manufacturer placed a stripped set on the market. It was accepted by the average consumer since it met his price. To keep in the competitive market, most manufacturers were forced into deleting the circuit.

Without dc restoration the blacks are usually dirty gray, the grays are lightened and the whites appear washed out. Video information is often coupled from the final video amplifier to the picture tube through a conventional coupling capacitor. This capacitor blocks the video amplifier dc potentials from the picture tube. At the same time, it blocks the necessary dc level of the video information. This results in a continuously variable video signal level. There is nothing to clamp the video signal at any given reference point. Contrast ratios are constantly changing and the only way to correct this problem would be to vary the contrast control 15,750 times per second.

Some of the more recent sets (and

particularly de luxe types) maintain the dc level—usually by dc coupling through from the detector to the picture tube. Older sets which lack dc coupling or de-restoration circuit can be improved by adding dc restoration.

For a set with a cathode-modulated picture tube, use the circuit in Fig. 2. Mount a 12AX7 near the video amplifier or as close as practical. (A 12AX7 is used here since the second section is used later in a cathode-follower circuit. If you decide not to use the cathode-follower circuit, a 6AL5 or similar tube will do instead.) Connect pins 4 and 5 together. Connect these to one heater pin of an adjacent tube. Connect pin 9 to the other heater pin. The resistor from the picture tube cathode to the brightness control should be approximately 100,000 ohms. Change it to 470,000 ohms and connect the rest of the circuitry as in Fig. 2. If you're adding the 6AL5 or 12AX7 dc restorer to a set with series-string heaters, **don't** tie the heater to the nearest tube. You'll have to add a small filament transformer instead. Therefore, with series-string sets, it is often best to use semiconductor diodes for dc restoration.

If the picture tube is grid-modulated, use the circuit of Fig. 3. This time no components have to be changed. A 12AX7 is also used here. Insert a 100,000-ohm and a 1-megohm re-

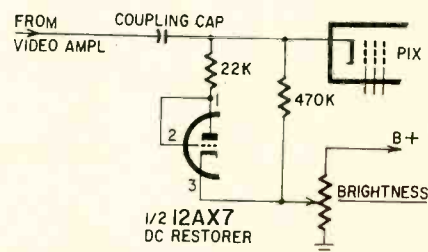
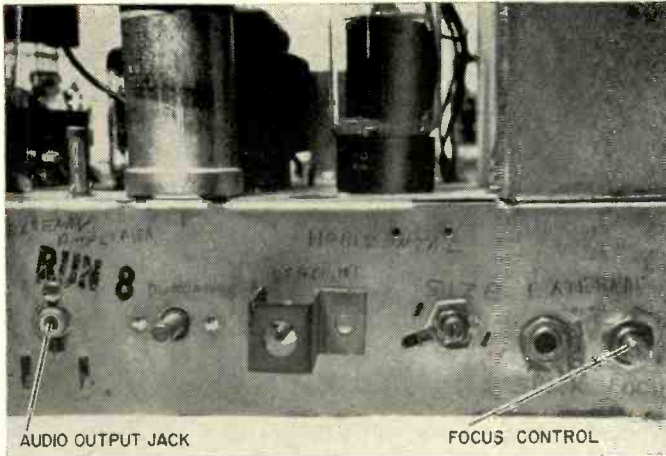

Fig. 2—Dc-restoration circuit for a cathode-modulated CRT.



Focus control and audio output jack for hi-fi amplifier are on rear of chassis.

sistor in series to ground and connect the tube across the 100,000-ohm resistor as shown in the figure.

Audio improvement

With the many good musical programs being televised (symphonies, popular music shows, etc.) TV audio systems leave much to be desired. The TV's FM sound channel can be enjoyed and appreciated as well as conventional FM broadcasts if reproduced through a well designed high-fidelity audio amplifier. The majority of TV audio amplifiers are single-ended single-stage jobs that do not reproduce the full audio spectrum with much fidelity. A good answer to this problem is to feed TV sound to a hi-fi system.

But first the audio signal must be removed from the TV receiver at a point where all audio information is available. To take this signal off at the volume control and feed it through a capacitor directly to an external amplifier, as some may recommend, is not acceptable. Losses are too high (especially high frequencies), hum may be introduced and impedance mismatch is great. Taking the signal off at the TV speaker is also a poor practice since audio reproduction is then limited to the capabilities of the TV audio amplifier. The only proper answer is to insert a cathode follower. With it, the signal is fed to the cathode follower direct from the audio detector. All high-frequency compo-

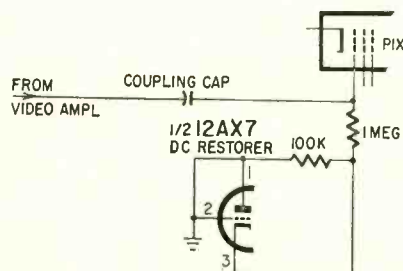
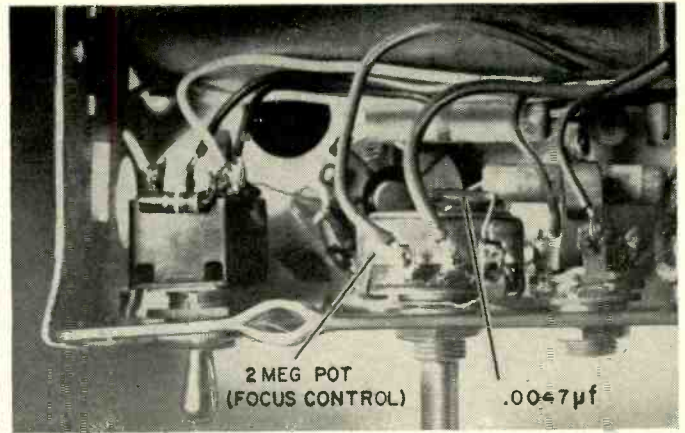
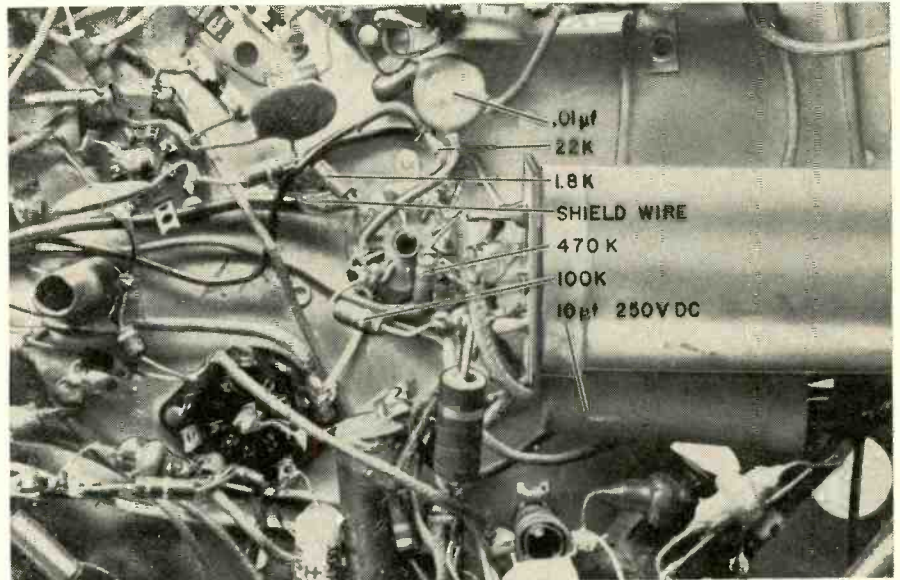

Fig. 3—Dc restoration for a grid-modulated CRT.

APRIL, 1963



How the focus control was added.



Where the cathode-follower was added.

nents are preserved and can be fed directly to an external amplifier or tape recorder.

The second section of the 12AX7 dc restorer is used here (Fig. 4). Connect the input capacitor (0.01- μ f) to the high side of the volume control or any other point which connects directly to the output of the TV audio detector. Connect the resistor of the plate supply low-pass filter to approximately 250 volts dc. The lead to the output jack (mounted in a convenient location such as the back apron) should be shielded wire and grounded only at one end. Keep the shielded wire from the TV

receiver to the external amplifier or tape recorder as short as possible. If your set doesn't have a power transformer, don't try this. Sets minus power transformers often have hot chassis and connecting a shielded cable between the TV and amplifier chassis makes the amplifier chassis hot, creating a shock hazard.

Inserting the circuitry described here may take a little time and cause you to miss few favorite TV programs, but by adding one tube and a few resistors and capacitors, you'll be repaid with improved performance and greater enjoyment.

END

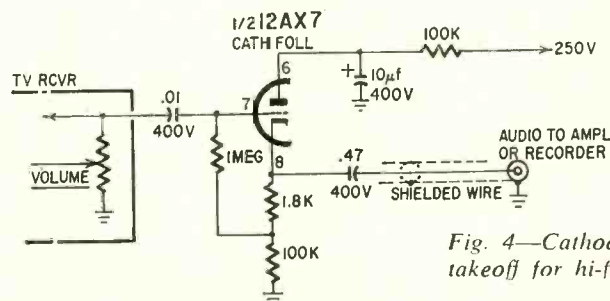

Fig. 4—Cathode follower permits audio takeoff for hi-fi amplifier input.

sensitive Light Meter easy to build

One-day project is simple, useful and accurate

The light-level indicator by Harold Reed (*Radio-Electronics*, June 1961) suggested to me this circuit (Fig. 1) for measuring light levels accurately. A rectifier-type ac milliammeter reads the current flowing through the photoconductive cell. It varies according to the cell's resistance, which varies in relation to the light level. To make it easier to spot small changes in light level, the instrument has three ranges, calibrated in terms of an available photographic exposure meter.

Accuracy is insured by compensating for line-voltage variations with R1. This is done while S3 is depressed,

* Conant Laboratories, Lincoln, Neb.

connecting R8 in place of the photocell on the LO range. Then R3 and R4 are adjusted for full-scale meter readings on the MED and HI ranges.

Construction

I have not attempted to miniaturize, but this is a matter of preference. I used a NSL-5 photocell suggested by Mr. Reed although others can be used. It has two raised glass seals for the leads. They nest neatly in two 3/16-inch holes drilled through one end of the metal box. Clamp the flange of the cell against the box with an Amphenol tube-socket mounting plate with its inner projection filed away (Fig. 2).

filament lamp of approximately 60 candlepower. You must be able to regulate its brightness. I used an old-fashioned dual-filament auto headlamp bulb with both filaments in parallel. Power was from a husky 6-volt transformer, fed from a Variac (Fig. 4). Clean the glass bulb and place some dark, nonreflecting material behind the lamp.

Now mark off a distance scale on the bench top, beginning with the sensitive part of the photocell 3 inches from the lamp filament. The end of the box is a good straightedge for marking the graduations, and makes for more accurate placement of the light meter during calibration. Succeeding scale marks

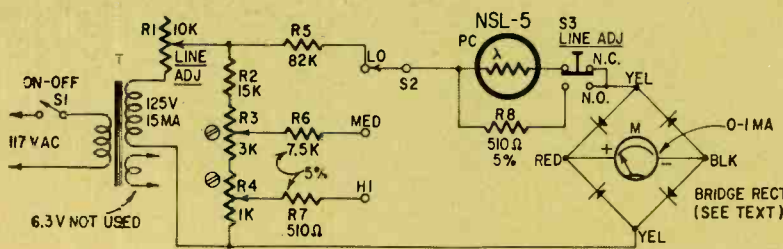
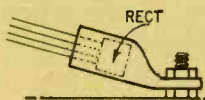
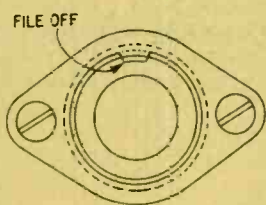

Fig. 1—Circuit of the accurate light meter.

- R1—pot, 10,000 ohms, linear taper
- R2—15,000 ohms, 1/2 watt
- R3—pot, 3,000 ohms, linear taper, screwdriver adjust
- R4—pot, 1,000 ohms, linear taper, screwdriver adjust
- R5—82,000 ohms, 1/2 watt
- R6—7,500 ohms, 1/2 watt, 5%
- R7, R8—510 ohms, 1/2 watt, 5%
- M—0-1 ma, dc

PC—NSL-5, National Semiconductors, Ltd. of Canada photoresistive cell. Available from Harvey Radio Co., 103 W. 43rd St., New York 36, N. Y., and other sources.

- RECT—see text
- S1—spst slide or toggle switch
- S2—single-pole 3-position rotary switch
- S3—spdt pushbutton switch, momentary contact
- T—Power transformer: primary, 117 volts; secondary, 125 volts, 15 ma; 6.3-volt heater winding not used
- Case, to suit
- Miscellaneous hardware



Detail (Fig. 2, left) of the photocell mount and insulated mounting (Fig. 3, right) for the bridge rectifier.

The meter rectifier is a Conant SeB-ERM, but types B, B-C or B-ERM, which are more readily available, will serve a little better. Type B can be mounted directly on the metal chassis, but the others must be insulated. This is conveniently done with a short length of large spaghetti (Fig. 3).

The cadmium sulfide photocell has a considerable time lag, so once the cell is tightly covered to exclude all light, it takes several seconds for the meter reading to drop to a steady reading of about 1 scale division. This is the *dark current*. Balance it out with the meter zero adjustment.

Set up a "point light source" at one end of a table or bench at least 5 feet long. The source can be a concentrated-

increase the distance $\times 1.41$ (the square root of 2), so the distance doubles for each two scale marks. Therefore, the scale marks are at 3, 4.25, 6, 8.485, 12, 16.97, 24, 33.94 and 48 inches. The light reaching the cell decreases 50% as the meter is moved back from one mark to the next.

The cell must be shielded so it receives light through only a small angle for best accuracy. I used a 2 1/4-inch length of phenolic tubing, 7/8-inch ID, with the OD built up with gummed paper tape to match the OD of the cell body. It was painted dull black inside to kill reflection.

It is convenient to calibrate in photographic units, using the same numbers as camera f stops, but in reverse order.

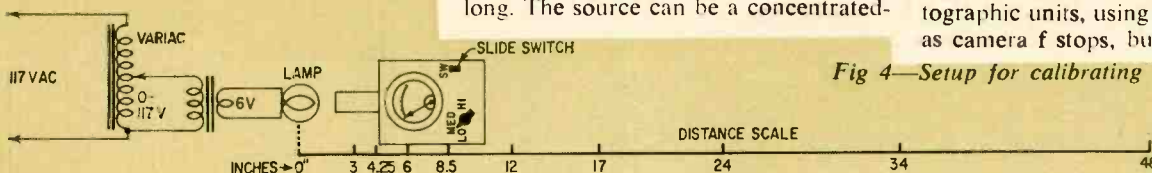
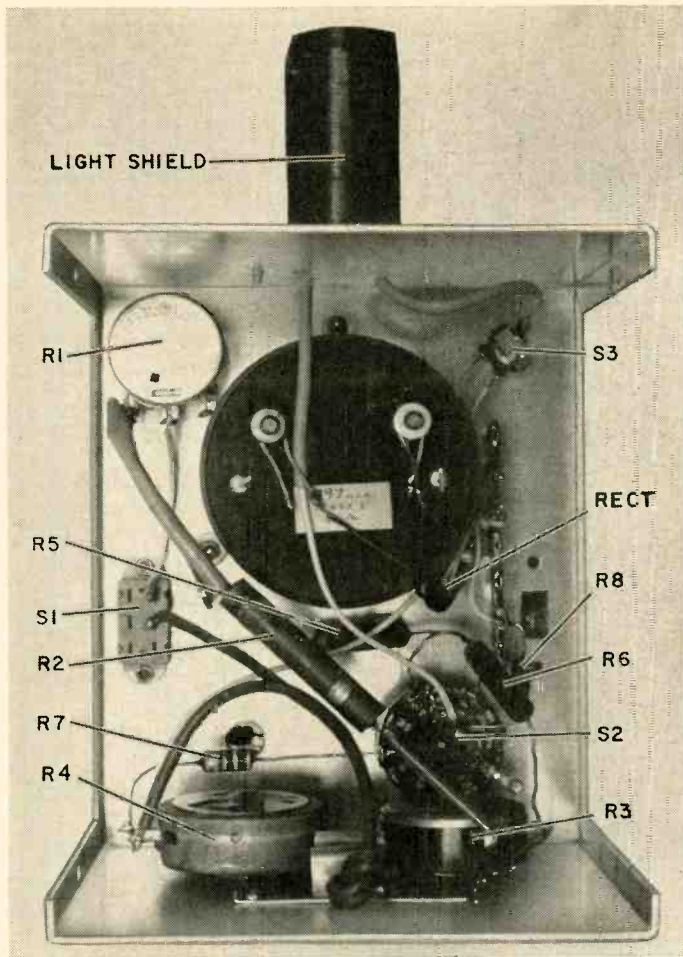

Fig 4—Setup for calibrating the unit.



Closeup shows parts layout inside case. Model shown was powered by external isolation transformer. You may wish to use a larger case and include transformer shown in Fig. 1.

Front-panel view of the completed instrument.

By this system, a typical exposure meter covers a range of 1 to 45, each succeeding graduation increasing roughly as the square root of 2, and representing double the light of the preceding graduation.

For a starting point, take light readings on all three ranges of the light meter, and compare them with the reading of an accurate exposure meter. Do this outdoors in bright sunlight and read the light off a light-colored wall. I got a reading of 22 on the exposure meter.

To cover the next two graduations, 32 and 45, place the light meter at the 6-inch mark of the distance scale, and adjust the lamp filament to give the same reading obtained for a light level of 22. Advancing to the 4.25-inch and then the 3-inch mark gave readings for light levels of 32 and 45, respectively. Then reduce light output to the original reading for 22 with the meter still on the 3-inch mark. Now moving the meter away from the lamp, mark by mark, gives readings for light values of 16, 11, 8, 5.6, 4, 2.8, 2 and 1.4 when the 48-inch mark is reached.

Return the meter to the 3-inch mark, turn down the lamp filament to produce the 1.4 reading and repeat the process to get readings for light levels of 1, 0.7, 0.5, 0.35, 0.25, 0.177 and 0.125. Do this in a dark room, using a small flashlight to find the marks and

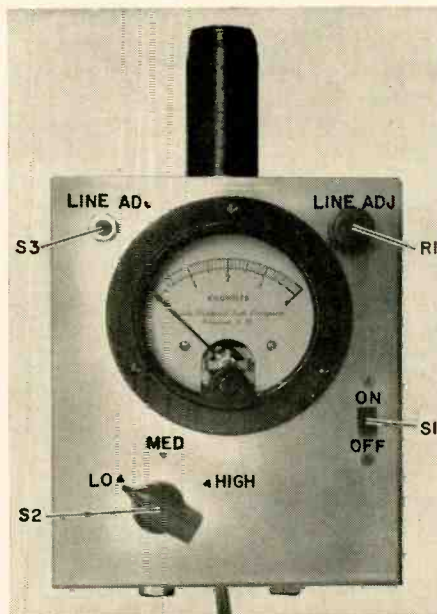

read the meter. Take readings on all three ranges at each point and make up a table with this data.

When using the instrument, for greatest change in meter reading for a given change in light level, use the HI range for light levels of 4 through 45. The MED range is best from 1 through 4, and the LO range for all light levels below 1. At 0.125, which is 1/64 of the minimum detectable on the exposure meter, I got a one scale-division reading on the LO range.

END

Complementary Symmetry Audio Output Circuit

THIS TRANSFORMERLESS OUTPUT CLASS-B circuit is used in the Admiral model 6V3 transistor radio.

When the signal at Q1's base is in its negative half-cycle, Q1 conducts, increasing base bias on Q2 and Q3. Increasing positive base bias increases collector current of an n-p-n transistor and decreases collector current of a p-n-p transistor. So Q2 is cut off and Q3 conducts heavily.

There are two current paths at this time. One, the dc path from B-minus, through the speaker voice coil, R1, D, Q1, and back to B-plus. The other, the signal path, is created by the charging of capacitor C1 through R2 and Q3.

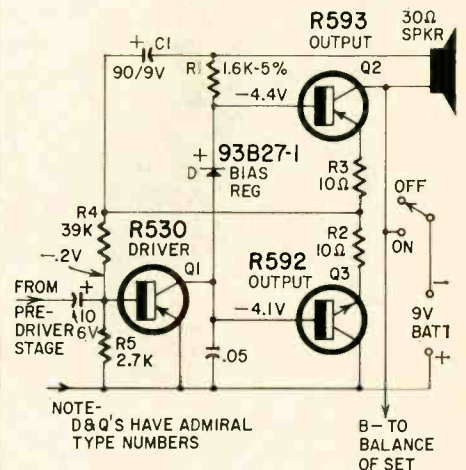

When the signal at Q1's base is in the positive half-cycle, the opposite happens and Q3 is cut off while Q2 conducts. Now the current paths are from B-minus through Q2, R3, R4, R5 and on to B-plus. The signal path is now from C1, discharging through the speaker voice coil, Q2 and R3.

As during both half-cycles, the audio signal appears across the speaker voice coil, the received signal is reproduced.—Warren Roy

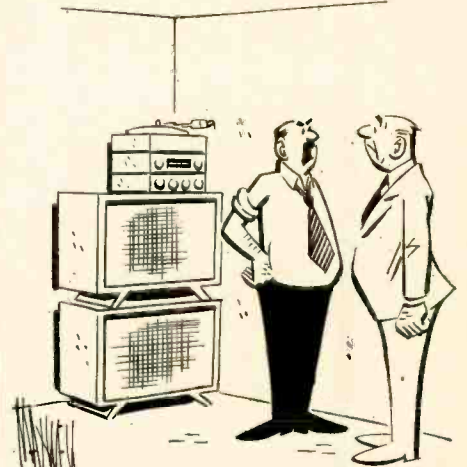

"Oh, yes, I enjoy stereo. On the other hand, my wife loves neatness."

OSCAMP— an ac bridge

By I. QUEEN
EDITORIAL ASSOCIATE

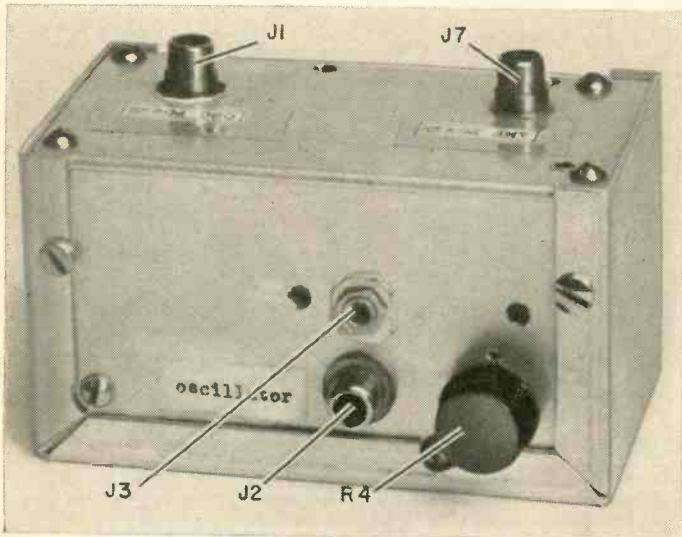

Power supply inputs are on top and oscillator outputs on one side.

AC BRIDGES ARE USED TO MEASURE CAPACITANCE, inductance and other parameters. Often a strong audio signal (from a tube type oscillator) is fed into the bridge, and balance (null) is detected with a pair of headphones. An alternate method is to apply a relatively weak signal across the bridge, and add an amplifier between bridge and headphones to boost sensitivity (Fig. 1).

The Oscamp is a convenient device for making bridge measurements. It combines a sine-wave oscillator with a multistage amplifier. Measuring only 4 x 2 x 2 inches, it weighs less than 9 ounces and is battery-powered. To use

it, simply connect input and output cables to the bridge, and plug in an earpiece. The oscillator and amplifier are independent, so either may be used separately around the shack or shop.

The completed Oscamp can be used to power the minicapacitance bridge (RADIO-ELECTRONICS, March 1960), the percent bridge (December 1959) and others that are energized by an audio signal, including transistor testers, etc. It eliminates the bother of having to connect a bulky line-operated audio generator and provides the convenience of aural detection which can tolerate loud signals yet



Fig. 1—Block diagram shows how the Oscamp is set up.

is highly sensitive to the tiniest output.

The amplifier is a modified PK-544, a five-transistor unit recently announced by Lafayette Radio Electronics. The few changes are easy to make. Snip off the battery plug which is part of the PK-544 and connect the battery leads to a phono jack mounted on the metal box. The outside shell is used as the negative connection. Connect the gain control leads to a 10,000-ohm pot (Fig. 2-a).

The black output lead is grounded to the box, but the black input lead is removed. It must not be grounded since it connects internally to battery positive! The two orange leads are for an on-off switch if you want one. Since the battery may be plugged in, there is no need for a switch and the orange leads are shorted.

A single 1.5-volt cell will power the amplifier, although 9 volts is specified for it. The output impedance of the PK-544 is about 10 ohms, so any low-impedance earpiece may be used.

Fig. 2-b shows the oscillator circuit, a simple Hartley with C1 determining frequency. The larger the capacitor, the lower the frequency, the better the waveform, and the smaller the output. A 0.25- μ f capacitor corresponds to about 800 cycles. Too large a capacitor will prevent oscillation altogether. All oscillator parts except the output control are mounted on an insulated strip about 3/4 by 2 3/4 inches.

Both units fit easily into the 4 x 2 x 2-inch aluminum box. The amplifier is held in place with four threaded spac-

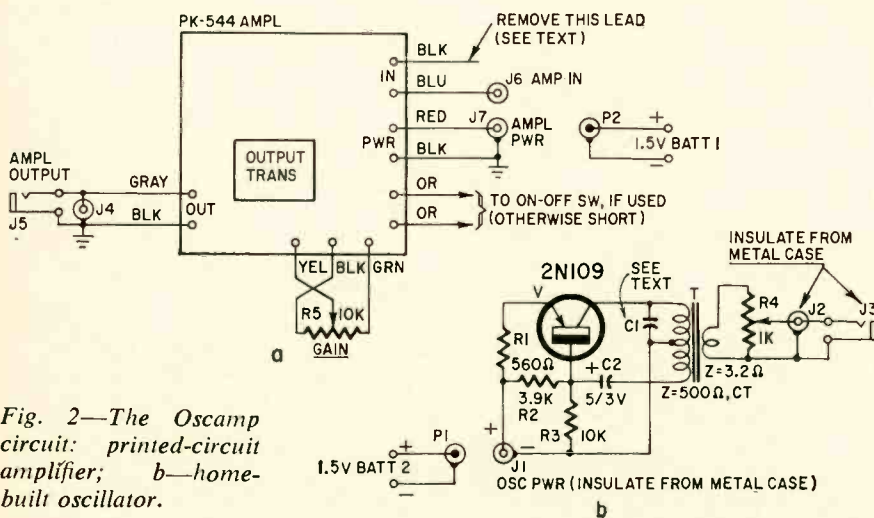
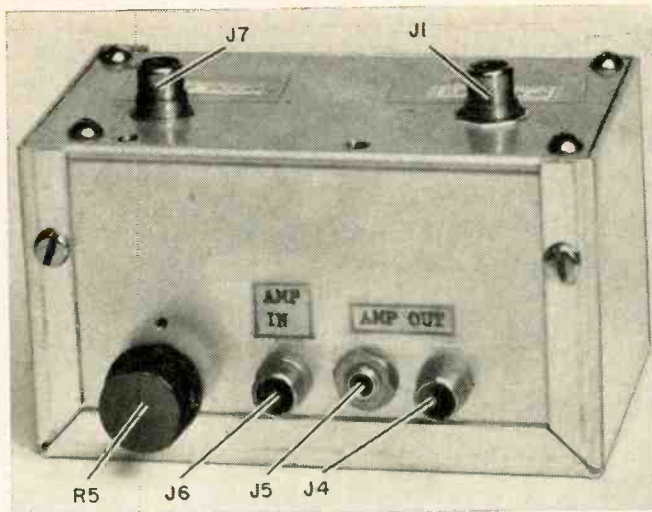
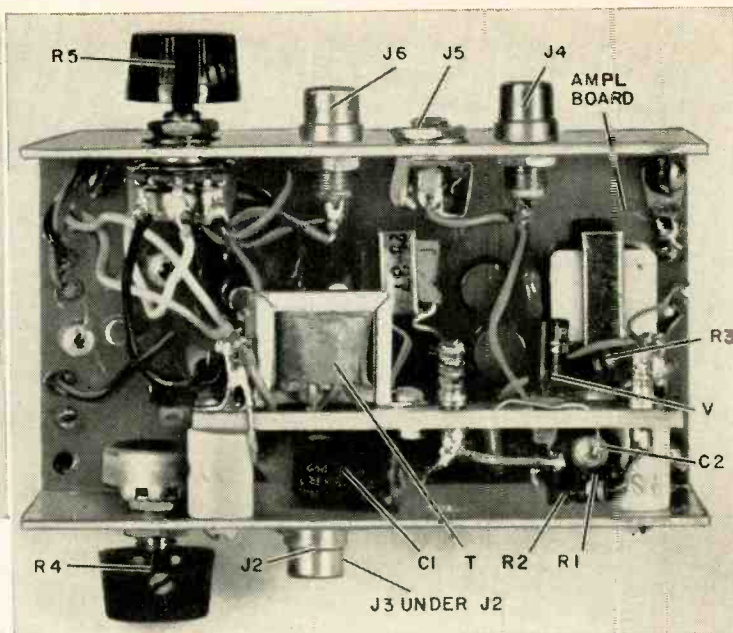

Fig. 2—The Oscamp circuit: printed-circuit amplifier; b—home-built oscillator.

- R1—560 ohms
- R2—3,900 ohms
- R3—10,000 ohms
- R4—pot, 1,000 ohms
- R5—pot, 10,000 ohms
- All resistors 1/2-watt 10%
- C1—see text
- C2—5 μ f, 3 volts, subminiature electrolytic
- BATT 1, BATT 2—1.5 volts
- J1, J2, J4, J6, J7—phono jacks
- J3, J5—phone jacks
- T—output transformer: primary, 500 ohms, ct; secondary, 3.2 ohms (Argonne AR-119 or equivalent)
- V—2N109
- Printed circuit amplifier (Lafayette PK-544 or equivalent)
- Case—4 x 2 x 2 inches
- Transistor socket
- Low-impedance earpiece
- Miscellaneous hardware



Other side reveals amplifier input and output jacks.



Parts arrangement inside the compact case.

ers, and the oscillator with two threaded spacers.

One important point that must be made is: *The input and output of a bridge do not have a common terminal. Since the amplifier output has been grounded (to the box), the oscillator output must not be grounded. Therefore, I insulated the output phono jack of the oscillator from the box. For con-*

venience, I added an *earpiece* jack for the oscillator too, and it must also be insulated.

Tests showed that a small residual tone remained at bridge balance (due to leakage) when a common battery was used for both oscillator and amplifier. To reduce this I use separate power supplies. A single cell is enough for each circuit, but the battery phono jack

for the oscillator should be insulated from the box. This isolates one supply from the other.

The separate oscillator and amplifier circuits are available for general use in tests and measurements. The PK-544, while definitely not a hi-fi amplifier, has high gain and can operate a speaker. For maximum output you can apply up to 9 volts to it. END

Panel Meters Need a Home

By E. C. CARLSON

PROPER CARE OF EVEN SURPLUS PANEL meters is just as important to their accuracy as the gentle handling given to the best multimeter.

For maximum repeatable accuracy, meters should always be held in the same vertical, horizontal or angled position when measurements are taken. When they are mounted in a protective

Fig. 1—Meter case assures repeatable readings (and keeps meter on the bench!)

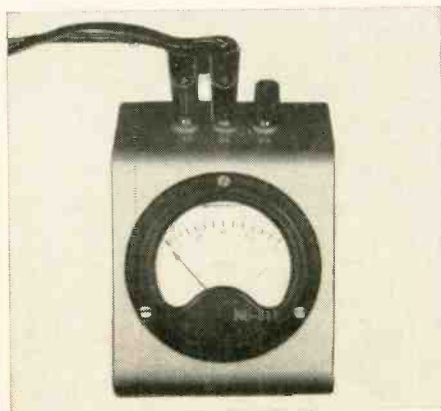

case, the proper angle is assured for repeat measurements (Fig. 1).

Meters marked "calibrated for steel panel" must be mounted in a steel plate to maintain their calibration. The steel plate can be mounted inside the nonmagnetic case front of plastic or aluminum meter boxes.

Special meters that are used infrequently or that must be often carried can be protected from dirt and breakage by mounting them in a file-card box (Fig. 2).

Using five-way binding posts helps eliminate most bad connections. Fig. 1 shows three posts for a 0-15- and 0-150-volt meter. Spaced $\frac{3}{4}$ inch apart, they will accommodate a dual banana plug. Meters with low-range movements and built-in shunts or multipliers can often be modified by bringing out an extra lead from the meter housing to a third terminal on the case. This way you can either bypass the shunt or multiplier and use the sensitive movement directly, or use the meter on its original range.

A word of caution: plastic cases and meter faces often collect an electrostatic charge that completely disrupts meter readings unless an anti-static solu-

tion is used on both sides of the plastic surfaces. Commercially mounted meters have this solution applied at the factory, but it *must* be renewed when the plastic surfaces are cleaned. This anti-static solution can be obtained through parts distributors and from some meter manufacturers. Complete instructions are given in the meter instruction manuals and with the anti-static solution. END

Fig. 2—Seldom used meters can be mounted in covered boxes for protection.

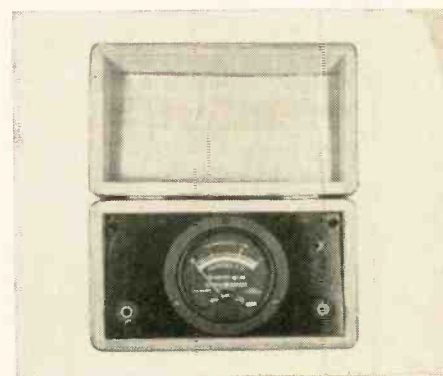

SERVICE CLINIC

Conducted by JACK DARR
SERVICE EDITOR



This column is for your service problems—TV, radio, audio or general and industrial electronics. We answer all questions individually by mail, free of charge, and the more interesting ones will be printed here.

If you're really stuck, write us. We'll do our best to help you. Don't forget to enclose a stamped, self-addressed envelope. Write: Service Editor, Radio-Electronics, 154 West 14th Street, New York 11, N.Y.

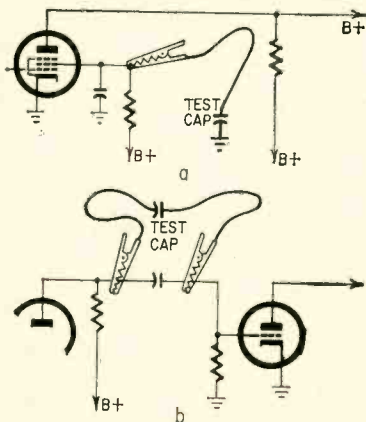

Fig. 1—Jump a known good capacitor across the suspected unit to check for an open.

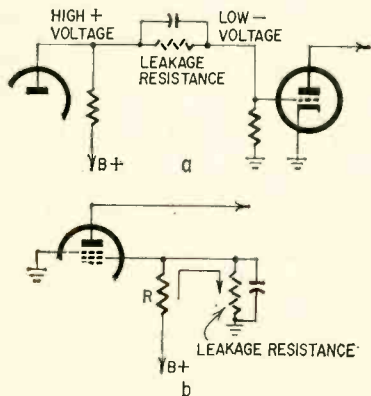

Fig. 2-a—Leakage through capacitor puts high voltage on next grid. b—Leaky bypass causes added voltage drop across R, lowering screen voltage.

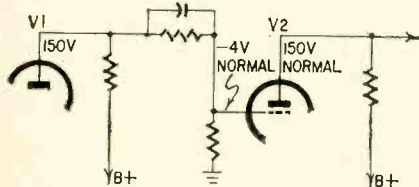

Fig. 3—Coupling capacitor leakage could drop plate volts on V2 to 75, raise a grid, causing distortion; leakage in bypass capacitors, reducing the voltage

WHAT DO WE HAVE TO KNOW ABOUT A CAPACITOR in an electronic circuit? Three things: Is it the right size? Is it open? And is it leaky? We need simple tests that will answer these three questions fast and accurately. You can make many such tests with a vtvm, and you'll find them useful in everyday service work.

Open capacitors

These are the easiest to spot. Just pick up a capacitor somewhere near the right size and connect it across the suspected one (Fig. 1).

If you're checking a capacitor in the middle-size range, say a .05- μ f unit, you can use any size from .01 to 0.1. How? Simple. If the suspected capacitor is open, it's having some effect on the circuit—oscillation, distortion, loss of signal. So if you bridge a good capacitor across an open one, something's going to happen. If it's oscillating, the oscillation will stop, or at least change pitch (lower its frequency) very noticeably. If it's an open coupling capacitor a good capacitor of any size across it will pass signal and you'll get a burst of sound or signal.

Size? So, after this test has shown the old capacitor to be bad, disconnect it and replace it with one of the proper capacitance.

Incidentally, if you're looking around in vhf tuned circuits for open capacitors, try touching suspected points with the blade of a dial screwdriver, about 3 to 4 inches long. This will make a fairly good substitute for capacitors in the 3-to-5 pf (μ mf) range!

Leakage testing

This is almost as fast. You want to know if there is enough dc leakage through this capacitor to upset the circuit. For example, plate voltage leaking through a coupling capacitor to a grid, causing distortion; leakage in bypass capacitors, reducing the voltage

across the circuit, and so on. Fig. 2 shows some examples.

To check, simply disconnect the ground- or low-voltage end of the capacitor. Connect your vtvm to the voltage point and turn the set back on. Now touch the open end of the capacitor to ground. If the dc voltage drops, it's leaking.

If the plate voltage on a tube is mysteriously low, although the supply voltage is OK and the tube is good, look out for a very small dc leakage in coupling capacitors (Fig. 3). A voltage difference of even 1 or 2 volts is enough to upset grid bias and cause a tube to draw far higher plate current than it is supposed to!

Almost all coupling capacitors are connected between a plate (with high positive voltage) and a grid (with negative voltage). Quick test? Disconnect the grid end of the capacitor and connect your vtvm to it (Fig. 4). If you get a permanent reading, the capacitor is leaking. Double-check. Ground the end of the capacitor, with the meter probe still connected. This discharges the capacitor. If the voltage reading comes right back, you know it's leaking.

Check all suspected coupling capacitors this way. For example, the one used in the diode circuits of horizontal afc circuits. But, you say, there is no high dc voltage in that circuit to make this check. So, take the capacitor completely out of the circuit, and touch one end to a source of high dc voltage, while the meter is still connected to the other end. A small alligator clip is very useful for this test. There are several types that will clip to the end of your vtvm probe (Fig. 5). By the way, you can also use this test to see if small capacitors are open. Discharge the capacitor by touching the open end to ground. Then

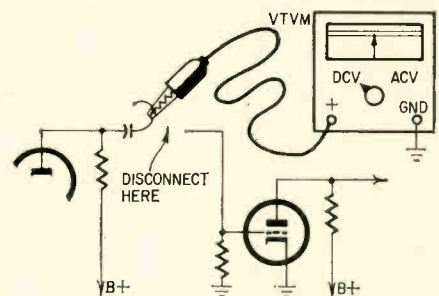

Fig. 4—Lift one end of suspected capacitor and measure the dc voltage on it to check for leakage.

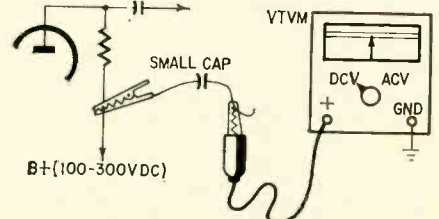

Fig. 5—Permanent dc voltage on open end of capacitor indicates leakage.

*no question
about it —*

the **JFD**
LPV $\frac{L(n+1)}{L_n} \cdot \tau$
IS A WINNER

**“6 db BETTER
THAN THE BEST!”**

If you are installing JFD Log Periodic LPV's, no doubt you will agree with this report from R. L. Monroe, a leading TV antenna service-dealer of Charleston, West Virginia—a problem reception area.

“It beats all, it beats everything that I have ever seen. Not only that, but this antenna is better than 6 db better than the best that I have installed. It pulled in a consistently clear picture from Columbus, over 130 miles away.

**** ** * ** * “It's just great on color —turns browns into real reds, faded bluish greens into brilliant greens, and completely eliminates the chronic ghost problems we have been suffering from in this area.”*

****I have been in this business since 1948, which is a considerable time, particularly in the valley, and have yet to see any antenna, even near to this log periodic antenna in performance of the things I have wanted.”*

Why the JFD Log Periodic LPV Outperforms Every TV Antenna Ever Made!

The log-periodic LPV blows the whistle on cumbersome antennas with their “Chinese puzzle” combinations of collectors, directors and reflectors. Now a single precisely-engineered antenna—the first based on a geometrically-derived *logarithmic* scale—actually *tunes* itself to the desired channel for unprecedented performance in crisp black and white or stunning color—plus FM STEREO. Is it any wonder that never before have so many installers and techni-

cians so quickly acclaimed a TV antenna?

We would like to tell you more about the LPV, and how its *frequency independent* characteristics, have broken through distance, ghost and interference barriers to bring clear, steady pictures into previously “impossible” areas. Write today for your log periodic LPV Sales Kit. Better yet, call your JFD distributor and try one with our money-back guarantee of a better picture. You will prove it to yourself.

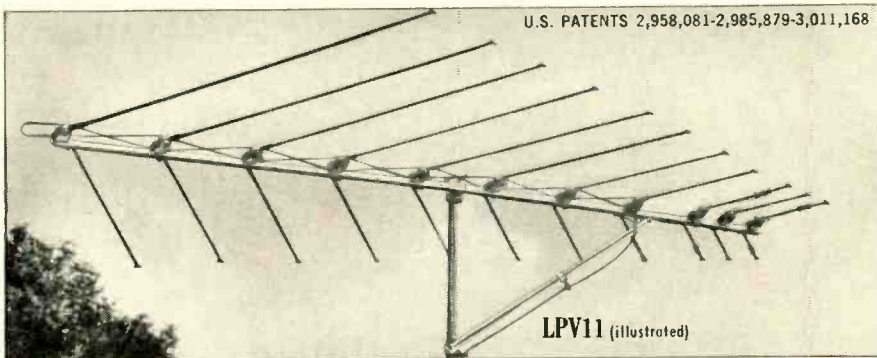

Developed by the University of Illinois Antenna Laboratory—Now Serving in Satellite Telemetry—Adopted to TV by JFD! **THE LOG PERIODIC LPV ENDS THE ERA OF ANTENNA COMPROMISE! FOR THE FIRST TIME ONE SCIENTIFICALLY FORMULATED ANTENNA CONFIGURATION SATISFIES ANY LOCATION DEMAND:**

Harmonically resonant V-element operate on the Log-Periodic Cellular Principle in the Fundamental and Third Harmonic Modes for unprecedented performance—in color—in black and white—plus FM STEREO

LPV17:	18 Active Cell and Director System—up to 175 miles	\$59.95, list
LPV14:	15 Active Cell and Director System—up to 150 miles	\$49.95, list
LPV11:	11 Active Cell and Director System—up to 125 miles	\$39.95, list
LPV8:	8 Active Cell and Director System—up to 100 miles	\$29.95, list
LPV6:	6 Active Cell System—up to 75 miles	\$21.95, list
LPV4:	4 Active Cell System—up to 50 miles	\$14.95, list



JFD **ELECTRONICS**
CORPORATION

15th Avenue at 62nd Street, Brooklyn 19, N.Y.
JFD Electronics-Southern Inc., Oxford, North Carolina
JFD International, 15 Moore Street, New York, N.Y.
JFD Canada, Ltd., 51 McCormack Street, Toronto, Ontario, Canada
401-144 W. Hastings Street, Vancouver 3, B.C.

Now...build your own TOP QUALITY TV SET

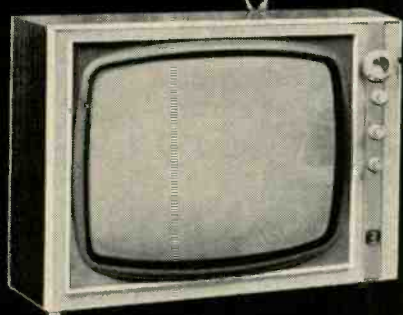

- Assemble America's First COMPLETE TV SET KIT
- Enjoy a new sense of accomplishment
- PERFORMANCE GUARANTEED

You don't have to know Electronics to build Conar's "Custom 70." All you need is a screwdriver, pliers and a soldering pencil. A fascinating, practical project that rewards you with years of superb viewing from this professional, compact, attractive receiver. Conar's "Custom 70" kit includes everything you need—chassis, tubes, "slim-line" cabinet, parts, latest model 19" aluminized picture tube with 206 sq. in. of viewing area, complete instructions and picture diagrams for easy assembly. Every part of highest quality. MONEY BACK GUARANTEE from NRI, with a record of nearly 50 years of pioneering in Electronics. Mail coupon.

SEND \$2.00 For ASSEMBLY MANUAL (Credited to your order)

CONAR Division of National Radio Institute

CONAR DC3C
3939 Wisconsin Avenue, Washington 16, D. C.

- Enclosed is \$135.00. Ship complete TV Set Kit at once. I will pay shipping costs upon receipt. I understand the prices include 10% U. S. tax.
- Enclosed is \$2.00 for Assembly Manual. Send me facts about monthly payment plan and "Custom 70" booklet.
- Send me facts about monthly payment plan and "Custom 70" booklet.

Name.....

Address.....

City.....Zone.....State.....

touch the B-plus. If the capacitor is not open, you'll get a small kick reading from the charging current.

Vertical roll

I've a Motorola 21T57 TV on the bench. When it is first turned on, it rolls vertically. As it warms up, it gets better. The vertical hold control runs at almost its maximum position. It still rolls at times when operating. Also, the other adjustments, such as vertical size and linearity, affect the vertical hold. How can this be stopped?—K. J. D., Kingsville, Tex.

First, resetting vertical adjustment controls always affects the hold. By al-

voltage readings you gave, I'd say that your main trouble is in the horizontal oscillator circuit.

This could be a bad yoke, which would upset the boost voltage, and I note that you show the damper tube plate and cathode as exactly the same voltage. This is a sure indication of boost troubles. Try disconnecting the yoke and temporarily substituting the horizontal section of a similar yoke to see if this brings the boost voltage back up. The horizontal oscillator is fed from the boost in this set.

Flyback failures

I'm beginning to get pretty sore at ——. I've been using them for

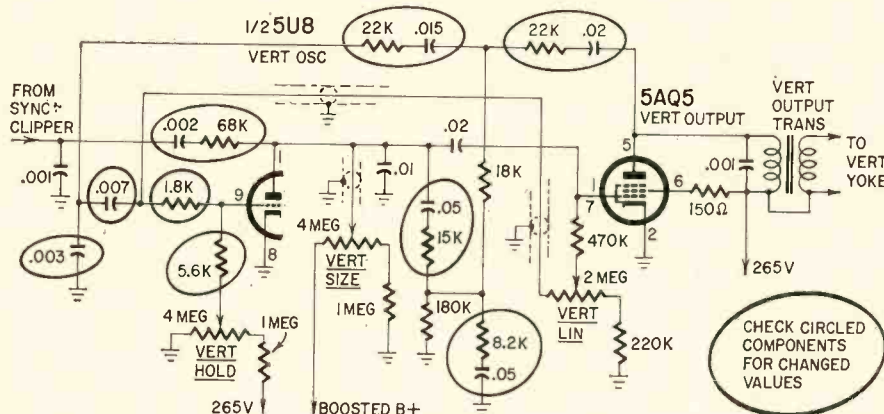

Fig. 6—Changed resistance and capacitance values in vertical oscillator output stages is likely to cause vertical roll.

tering the waveshape of the vertical oscillator, they can make it difficult for the sync to trigger the oscillator at the proper time. So, when checking for this, always set the size and linearity controls for a correctly proportioned raster first. This should be about 1/2-inch overscan at top and bottom of the screen.

Second, weak tubes are the most common cause. After this comes defective resistors or capacitors. From your statement that the hold control is at the end of its range, a defective component is the most likely thing. Check all the R-C combinations in the oscillator circuit; one of them has changed (Fig. 6).

No high voltage and boost

I have an Admiral 21D1 which has turned into a tough dog. Sound, no picture, no raster. The cathode resistor (47 ohms) is burning up, there's no drive on the grid of the 6BQ6, and I have no boost voltage. I accidentally connected the boost filter capacitor to the horizontal phase comparator 6AL5. Do you think I damaged the yoke by doing this?—V. I. A., Ozone Park, N. Y.

I wouldn't think that any damage was done by this temporary misconnection as you would have to go through the 12,000-ohm shaper resistor to get to the tube. From the symptoms and the

quite a while, and I've had several of them burn up. They arc to the shield, flash over to anything in the vicinity, including me, and don't last more than 2 or 3 weeks. They run hot, too. What do you think about this situation?—H.S., Comstock, Mich.

Like yourself, I have used — (a very well known brand of flyback transformers) for many years now, and I have never had the trouble you describe. From the symptoms you gave, including the fact that all of the troublesome sets were within a mile or so of the river, I'd be tempted to say that this was mainly a humidity problem.

Notice that most of the troubles seem to originate in flashovers, and that you say all are running hot. One thing which *must* be checked when replacing a flyback is the operating temperature. Check horizontal output tube plate current, screen dissipation and so on. If a flyback is run above normal operating temperatures, it will be prone to softening of the wax and flashover trouble. This can happen to any flyback under these circumstances.

So my recommendation would be to check the replacements for temperature very closely, before returning them to their homes by the river. Also, it would be a very good idea to give them a little help in the form of additional insulation. Try spraying about three coats of Krylon or a similar acryl-

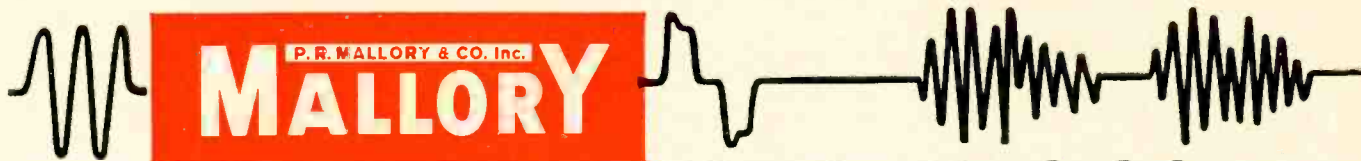

Tins for Technicians

Mallory Distributor Products Company
 P. O. Box 1558, Indianapolis 6, Indiana
 a division of P. R. Mallory & Co. Inc.

The new generation of batteries ... how to use them

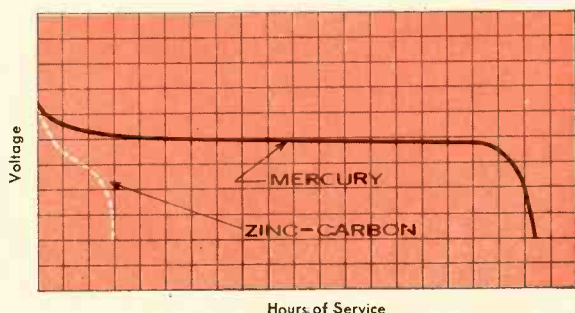
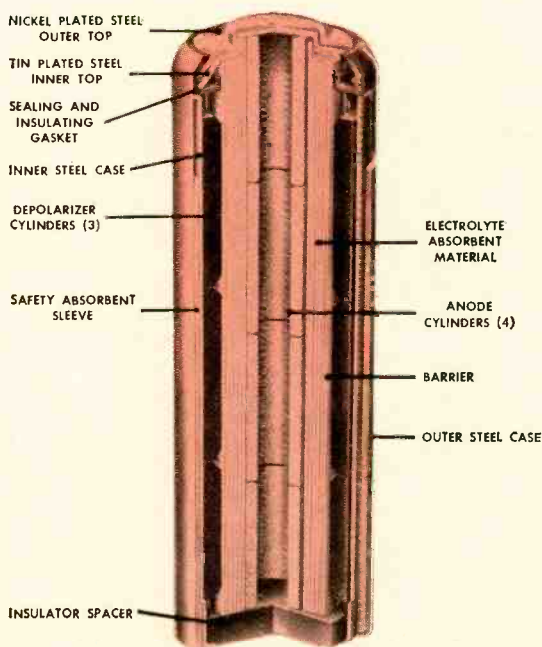

You may not realize it, but dry batteries used in modern electronic circuits are as different from old style dry cells as 1962 autos are from the Model T.

Of primary interest to you as a technician is the mercury battery. Instead of the ordinary combination of zinc, carbon, and electrolytic compounds, Mercury batteries use mercuric oxide and a zinc amalgam in combination with an alkaline electrolyte. This chemical system produces a dry battery uniquely matched to solid-state electronic circuits. For example, Mercury batteries have about four times the milliampere-hour capacity of ordinary batteries of the same physical size.

Not only do mercury batteries contain more actual power, they hold this power for long periods of time. Ordinary batteries start to lose power from the instant they are assembled *whether used or not*. On the other hand the storage life of a mercury battery is amazing. We've had some on storage test for more than nine years . . . AND THEY'RE STILL ALIVE.

Perhaps the best thing about mercury batteries is their steady output voltage. It stays nearly constant throughout the entire life of the battery (see chart). Ordinary battery voltage drops steadily. Constant voltage is important in solid state circuits . . . it means constant gain and linearity.

Terminal voltage on a mercury cell is 1.35 volts $\pm 1/2\%$! This is so accurate there's a special multi-voltage reference battery (Pt. No. 303113) that's widely used as a secondary voltage standard. It's excellent for setting scopes, meters, etc., and all sorts of lab work. We'll be happy to send complete information. Just ask.

Mercury batteries are a Mallory development. We like to think we're experts on them. But we know there are jobs a mercury battery shouldn't do. Jobs where very high surge drains or continuous heavy drains are required . . . flash cameras, flashlights, movie cameras, etc. So we developed the Mallory Manganese Battery. It's the king of heavy drain batteries . . . with excellent storage life and moderate price.

There are literally dozens of other battery systems available from Mallory. We simply don't have space to go into them here. But if you're interested in rechargeable batteries, or ultra low temperature types, or extreme low or high voltage types, or other exotic types, write to Dept. 762. We'll send the information.

Meanwhile, when you need a battery for a grid bias circuit, or a portable instrument, or a transistor radio, use a Mallory Mercury Battery. For flashlights and similar applications use Mallory Manganese Batteries. You can get them from your Mallory Distributor. He's the man to see for Mallory capacitors, controls, switches, semiconductors, and vibrators . . . and for all your electronic requirements.

NEW SAMS BOOKS

Test Equipment Circuit Manual

by Robert G. Middleton. Here's the publication long-awaited by technicians! This big 8½ x 11" manual contains complete schematics, descriptions, and specifications for 90 of the most popular test instruments in current use. Covers scopes, tube testers, VOM's, VTVM's, capacitance testers, sweep and signal generators, transistor testers, color-bar and crosshatch generators, and circuit analyzers made by Arkay, B & K, Eico, EMC, Heath, Hickok, Jackson, Knight, Mercury, Paco, Precision, Precision, RCA, Seco, Sencore, Simpson, Sprague, and Triplett. Nothing else like it—invaluable—a terrific value! 192 pages; 8½ x 11". Order TEC-1, only. \$4.95

Diode Circuits Handbook

by Rufus P. Turner. Here are 96 tested-and-proved small-signal diode circuits, exciting build-your-own electronic gadgetry to thrill the hobbyist, ham, experimenter, or student. Includes complete diagrams and descriptions for 20 different receiver circuits, 9 transmitter circuits, 6 audio circuits, 10 power supply circuits, 10 computer circuits, and 8 miscellaneous application circuits. Serves also as a useful diode circuit reference guide for technicians and engineers. 112 pages; 5½ x 8½". Order DIT-1, only. \$2.50

Servicing FM-Stereo Receivers

by Edward M. Noll. Only book of its kind—for the professional technician expanding into this booming new service area. Fact-packed chapters explain stereo system principles and basic receiver and multiplex adapter circuits; troubleshooting stereo receivers and adapters; antenna systems—basic types, gain and range; directivity problems, installation, system checkout. 182 pages; 5½ x 8½". Order SRN-1, only. \$2.50

So You Want To Be a Ham (3rd Edition)

by Robert Hertzberg, W2DJJ. Completely updated edition of this all-time favorite of newly-licensed and novice ticket aspirants. More valuable than ever—to help beginning amateurs get off to a good start. Gives latest license requirements and regulations, helpful suggestions for learning the code, advice on selecting equipment, and how to become a good operator. Includes new chapters on kit-building and antenna systems. 192 pages; 5½ x 8½". Order HAM-3, only. \$2.95

SAVE Servicing Transistor Radios

95¢ Three brand-new volumes (TSM-21, 22, and 23) in a single money-saving vinyl-wrapped package. Complete PHOTOFACT® service data for 115 current model sets, including Airline, Americana, Arvin, Bulova, Channel Master, Continental, Coronado, Emerson, Ever-Play, Futura, GE, Global, Harpers, Hitachi, Honey Tone, IIT, Lafayette, Maco, Magnavox, Matsushita, Motorola, Nordmende, Olympic, Panasonic, J. C. Penney, Philco, RCA, Realltone, Seminole, Silver-tone, Sony, Sylvania, Toshiba, Truetone, Webcor, Westinghouse, Zenith. 3 Volumes, 160 pp. each; 8½ x 11". Order TSM-52, only. \$7.95
Individual Volumes, each \$2.95

Principles & Applications of Tensor Analysis

by Matthew S. Smith. The ability to understand and apply tensor theory is a definite advantage in analytical engineering. This new text explains and demonstrates the theory and application of tensor analysis. Begins with basic theory, including Christoffel symbols and covariant derivatives; progresses into Riemann-Christoffel Tensors and differential geometry topics; presents important concepts of classical and relativistic mechanics in tensor form, including LaGrange's equations of motion, the classical solution and Geodesic equations for the two-body problem, Minkowski space-time and Lorentz Transformations, and Einstein's Gravitational Equations for the general theory of relativity. Includes full bibliography and subject index. 128 pp., \$6.95
5½ x 8½"; hardbound. Order TAS-1, only.

Replacement Guide for TV & Auto Radio Controls

Vol. 5. Bigger and better than ever—covers over 32,000 TV and 1300 auto radio models. Lists recommended replacement controls made by Centralab, Clarostat, CTS-IRC, and Mallory. 144 pages; \$10.00
8½ x 11". Order RGC-5, still only.

HOWARD W. SAMS & CO., INC.

Order from your Sams Distributor today, or mail to Howard W. Sams & Co., Inc., Dept. D-23
4300 W. 62nd Street, Indianapolis 6, Ind.

Send me the following books:

TEC-1 SRN-1 TSM-52 RGC-5
 DIT-1 HAM-3 TAS-1

\$_____ enclosed. Send FREE Booklist

Name _____

Address _____

City _____ Zone _____ State _____

IN CANADA: A. C. Simmonds & Sons, Ltd., Toronto 7

ic plastic into the flyback cage, letting each coat dry for at least 2 hours. Apply extra insulation, such as Colman's High-Voltage Putty, to points where arcing is apt to show up—the high-voltage rectifier socket wiring, the tire, core and so on.

You could write to the manufacturer and give him the same story. If there is anything defective in these transformers, as there *could* be, he will be happy to take care of it. I enclose his address.

Agc making trouble

In a G-E 14T009 TV, the grid of the first video if reads 0.1 volt instead of -0.5 volt, and the rf amplifier is the same. Other voltages are tolerable. Oh, for the good old days when there was

the vertical oscillator by disconnecting the sync. See if it will run close enough to the right frequency to allow a picture to be held on the screen with the vertical hold control only. If not, change some of the resistance values, or the capacitors, until it will free-wheel at the proper frequency. This will make it easier for the sync to hold.

If this doesn't work, check the amplitude of the vertical sync. I have a feeling that this is your trouble. Check the sync separator, integrator network and sync circuits.

CRT life too short

Are there any factory modifications that could be used to prolong the life of picture tubes in a 21-inch RCA chassis KCS-96B? It's gone through

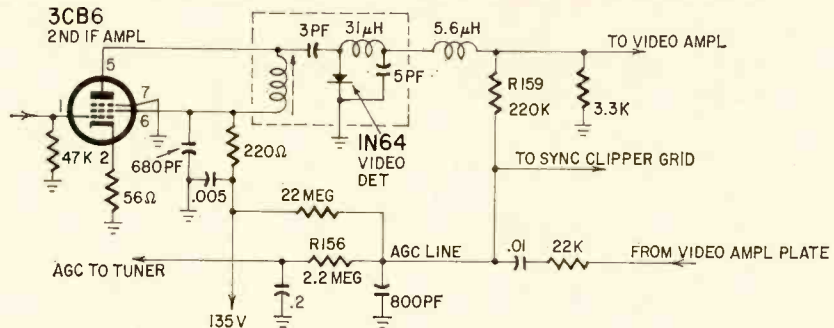

Fig. 7—Agc circuit in the G-E 14T009.

room to work in a TV set.—C. W., Rio Vista, Calif.

I suppose we all sigh for the good old days when there was more room to work in TV sets. I know I do. This circuit takes the agc voltage directly from the video detector, through R159, 220,000 ohms and R156, 2.2 megohms (Fig. 7). A 0.2-µf and an 800-pf capacitor are used for filtering.

I'd suggest checking the video detector crystal, by replacement, measuring the value of the agc filter resistors and checking the filter capacitors for leakage. You might also check the .01-µf coupling capacitor between the sync clipper grid and the video output plate for leakage. This could be bucking out some of your agc voltage if any positive voltage was leaking through here. The correct voltage on the 6AU8 sync clipper plate is -2.8 volts. If this is incorrect, that capacitor is probably leaky.

Vertical trouble

Though all resistance and voltage readings check ok, I've still got vertical troubles in a Muntz 721TS TV. It rolls when first turned on, then holds for a while, then rolls again. I've heated the resistors with a soldering iron and checked all the capacitors and tubes.—A. G., Cleveland, Ohio.

You've certainly done all the right things so far! Ordinarily, you would have caught it. So the trouble must be somewhere else. First, try free-wheeling

two picture tubes in less than 3 years. The third (rebuilt) tube is already using a booster.

The chassis is working normally, since I can get a perfect picture every time I put a new picture tube in it.—J. M. K., Aiea, Hawaii.

You're making an unwarranted assumption that the chassis is OK because it gives a good picture with a new CRT. Many things could be responsible for this trouble: high ac line voltage at the user's home, excessively high voltage on the tube, misset ion trap, etc. If I were you, I'd measure the heater voltage, also check the rest of the operating voltages.

If the filament voltage on the CRT is too high, try installing a small resistor to hold it down to about 6 volts.

To the best of my knowledge there are no factory modifications on this chassis dealing with CRT life. If all the operating voltages are OK, we have had very good life on this chassis.

I'd suggest using either a new CRT or a guaranteed factory-rebuilt tube the next time. Don't use off-brand rebuilds.

Video washout

We have an Admiral 20A7 in the shop that has all the symptoms of a bad CRT. But when we put a check tube on the set, we get the same symptoms! People's faces have patches of silvery light on foreheads, shirt fronts

Find it and Fix it in 1/2 the time!

EASILY SOLVES "TOUGH DOGS"... INTERMITTENTS... ANY TV TROUBLE



MODEL
1076

TELEVISION
BLACK & WHITE AND COLOR

ANALYST

By Easy Point-to-Point Signal Injection, You see the Trouble on the TV Screen and Correct it—Twice as Fast and Easy!

Simplified technique stops lost hours never recovered on "tough dogs", intermittents, and general TV troubleshooting. This one instrument, with its complete, accurate diagnosis, enables any serviceman to cut servicing time in half... service more TV sets in less time... satisfy more customers... and make more money.

With the Analyst, you inject your own TV signals at any time, at any point, while you watch the generated test pattern on the picture tube of the television set itself. This makes it quick and easy to isolate, pinpoint, and correct TV trouble in any stage throughout the video, audio, r.f., i.f., sync and sweep sections of black & white and color television sets—including intermittents. No external scope or waveform interpretation is needed. Checks any and all circuits—solves any performance problem. Gives you today's most valuable instrument in TV servicing—proved by thousands of professional servicemen everywhere.

Available on Budget Terms. As low as \$30.00 down.

Net, \$329.95

SIMPLIFIES COLOR TV SERVICING, TOO



Enables you to troubleshoot and signal trace color circuits in color TV sets, or facilitate installation.

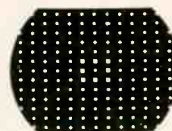

Generates white dot, crosshatch and color bar patterns on the TV screen for color TV convergence adjustments.

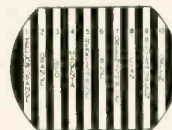

Generates full color rainbow display and color bar pattern to test color sync circuits, check range of hue control, align color demodulators. Demonstrates to customers correct color values.

Time-Saving, Money-Making Instruments Used by Professional Servicemen Everywhere



Model 960 Transistor
Radio Analyst



Model 360 V O Matic
Automatic VOM



Model 375 Dynamatic
Automatic VTVM



Model 700 Dyna-Quik
Tube Tester



Model 440 CRT
Rejuvenator Tester

See Your B&K Distributor
or Write for Catalog AP20-E



B & K MANUFACTURING CO.

Division of DYNASCAN CORPORATION

1801 W. BELLE PLAINE AVE. • CHICAGO 13, ILL.

Canada: Atlas Radio Corp., 50 Wingold, Toronto 19, Ont.

Export: Empire Exporters, 253 Broadway, New York 7, U.S.A.

and highlights; no detail at all in these places. The more the brightness and contrast are increased, the more this spreads.—W. R., Oak Harbor, Ohio.

This is video trouble! I wasted a good deal of time on a Philco with exactly the same symptoms not too long ago—loss of focus, washout of highlights. I replaced the video amplifier tube, which checked perfectly good, and the symptoms disappeared.

This effect, I'm sure, is due to gas in the tube. You're getting upper-knee saturation of the tube, at a much lower level than you should. This *could* be due to trouble in the plate circuit, but seems to be caused mostly by gassy tubes. Check the peak-to-peak amplitude of the video signal at the input of the picture tube. Compare the waveform you get here with that on the grid and you'll see what is happening. I expect you'll find a definite flattening of the video, not clipping but flattening from the white side. END

Technical Publication on Phonograph Record

"MUSIC FROM MATHEMATICS" IS THE name of a new record (Decca DL9103) which, its authors state, "constitutes a publication of several years of work carried out at the Bell Telephone Laboratories." The authors are J. R. Pierce, director of research of the laboratory's Communications Principles Div., M. V. Mathews and N. Guttman. The record is the result of work on the constitution of sound waves, undertaken with the help of an IBM 7090 computer and digital-to-analog output equipment, to change the digital sequences to musical sounds. The selections on the computer vary from pure experiment with various shapes of waves to arrangements of well known musical pieces and, in one case, an English song. The piece "Bicycle Built for Two," arranged by M. V. Mathews, illustrates how far synthesis of human speech has progressed since the Voder of the '30's. The words of the chorus could be mistaken for those of a human voice by anyone not aware of the nature of the record. The larger number of pieces are composed or arranged by Pierce or Mathews, with one by Guttman and others by three outside composers.

Reversing the usual "technical paper", in which a report is read and then supplemented by a demonstration, this "publication" is supported by a paper of some 15 pages entitled "Musical Sounds from Digital Computers." This, however, does not reach purchasers of the record, who do get a shorter report printed on the back of the record jacket. END

Puzzled about Hum-m?

By ANTHONY PRASIL

THE ARTICLE "PUZZLED ABOUT HUM" BY Norman H. Crowhurst which appeared in the January 1961 issue is excellent. It especially interests me because for many years I have been designing and building very-low-noise preamplifiers, both vacuum-tube and transistor types. Since these are required to amplify signals as small as the Johnson noise of the input resistance (between 1 and 10 μv , depending on the system bandwidth), the slightest amount of hum pickup is very obvious and must be eradicated. Doing this sort of work, one soon learns the many pitfalls which may be encountered and the way to cure the trouble at hand. You also learn to avoid the same mistakes in future designs.

One point which Mr. Crowhurst did not mention is important to those who may be building transistor preamps for magnetic phonograph pickups, microphone inputs or other low-level inputs. These must be hum-free, but may be mounted near a turntable motor or a power supply transformer or choke in a 60-cycle magnetic field which induces excessive hum in the signal circuits.

A vacuum tube is a high-impedance voltage-operated device. It is susceptible to pickup from electric fields which can induce voltages in high-impedance circuits. This type of pickup can be eliminated. Simply place conductive metallic shielding between the source of the disturbing field and the place where the voltage is induced in the signal circuit.

Transistors are current-operated devices used with low-impedance components and circuits. Electric fields have little effect in producing hum pickup. Magnetic fields, however, can produce hum currents in these circuits. The lower the impedance, the greater the hum. Unfortunately, electrostatic shielding does not attenuate a 60-cycle magnetic field. Magnetic shielding of high-permeability iron is not available to the average experimenter and does not completely eliminate the trouble anyway. It merely reduces it.

The typical symptom of 60-cycle magnetic field pickup is a transistor preamp that picks up hum even when it is completely enclosed in a metal box. The hum magnitude changes as the

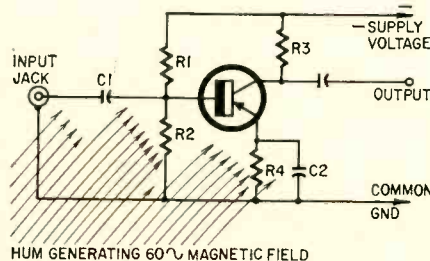

Fig. 1—This wiring arrangement is no good if you are trying to keep magnetic hum to a minimum.

preamp is moved or turned about so that it changes its orientation in the ever-present stray magnetic field. There will be some orientation that gives minimum or zero hum pickup. Invariably, it will be at an angle that makes it impossible to mount the preamp.

The next question is: How can an amplifier be designed so it is immune to the magnetic hum field, or, if we have an amplifier that is plagued by this trouble, how can we cure it?

The amount of pickup is proportional to the amount of magnetic flux enclosed by the critical loops in the circuit. The most critical part of any circuit is generally the input circuit, where any disturbance is amplified by all of the amplifier stages. The loop formed by the signal input lead to the transistor, from the transistor to ground and the ground back to the input, is the most critical and the wiring should be laid out so that it encloses the least area and con-

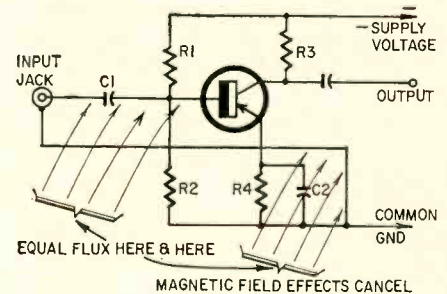

Fig. 2—Slight change in wiring makes circuit relatively hum free.

sequently the least amount of magnetic flux. Fig. 1 shows the right and Fig. 2 the wrong way to lay out wiring for minimum hum pickup.

The input loop shown in the illustration consists of input coupling capacitor C1, the base-to-emitter conductance of the transistor, and emitter bypass capacitor C2. Base-bias resistors R1 and R2 and emitter-bias resistor R4 are not a part of the loop. Their resistance is considerably higher than the capacitors' reactances. In the "wrong" circuit configuration, a great many magnetic flux lines are enclosed in the loop, causing hum. In the "right" configuration, there are fewer lines of flux within the loop, and there are also an equal number of flux lines on each side of the point where the ground wire to the input connector crosses the emitter lead. Because of this crossover, the induced hum on one side is in the opposite polarity to that induced on the other side, and, if the areas on either side are equal, the two hum components being equal and opposite will cancel.

Thus for nothing more than careful attention to wiring layout, the finished product can be made immune to the effects of 60-cycle fields ordinarily encountered. END

THE SECRET'S IN THE CIRCUIT

BLONDER-TONGUE TV/FM COUPLERS

You can't tell a coupler by its case. However, a view of what's inside can tell you why a coupler will deliver clean, interference-free signals to a multi-set installation. Examine the circuitry of Blonder-Tongue couplers. Compare them with ordinary units. It's easy to see why they are the best selling quality couplers on the market.

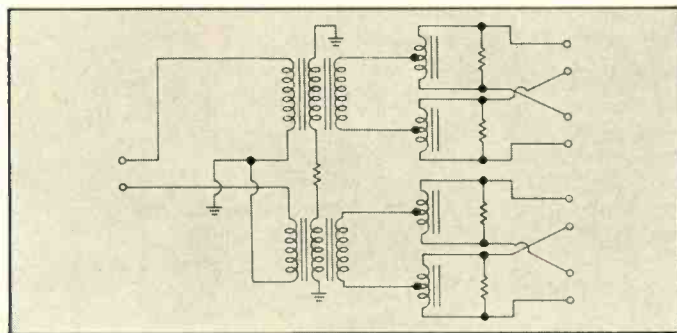
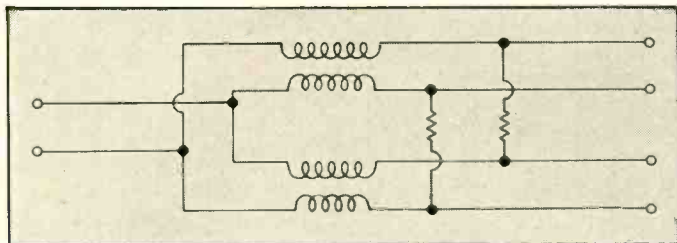

THE TIME TESTED BLONDER-TONGUE A-102

This is the champion performer among all 2-set couplers judged on the basis of its popularity with technicians and TV viewers. The A-102 offers 12 db isolation *with only 3 db insertion loss*—half the insertion loss of the average 2-set coupler! Designed for both TV and FM, it is especially effective in weak signal areas. For FM stereo, this low loss hybrid type unit is the answer. A look at its circuitry will tell you why.

- patented bifilar transformers
- backmatched for precise impedance match
- heavy conductors end burnouts. List \$3.20

NEW COLOR-ENGINEERED COLOR-4

Where a color TV set is one of the sets receiving signals from a single antenna, the Color-4 is the only answer. This super deluxe 4-set coupler offers maximum interset isolation (16 to 24 db), excellent impedance match and only a 6.5 db insertion loss. The Color-4 uses ferrite broadband transformers in balanced bridge design and it has a voltage standing wave ratio of less than 1.5. Result: Lower inherent insertion loss, less smear and ghosts, sharper pictures than any other 4-set coupler.

- Ferrite broadband transformers in balanced bridge design
- VSWR of outputs and inputs no greater than 1.5.
- Backmatched

List \$9.95

BLONDER-TONGUE TV & ANTENNA COUPLERS

NEW BLONDER-TONGUE ALL CHANNEL SET-2. The SET-2 is one of the few couplers available today that can deliver full power signals to two UHF, or a VHF and UHF receivers operating from the same antenna. Effective straightforward resistive circuit provides 12 db interset isolation with 6 db loss. While it's effective on VHF and FM, the low loss A-102 is a better choice for FM stereo. List \$3.20

BLONDER-TONGUE A-104 FOUR SET COUPLER. Inductive — resistive coupler for VHF and FM. Feeds 4 VHF receivers from one antenna, or mixes 4 antennas into one line. Isolation: 12-20 db. Loss: 7.5 db. List \$4.50

BLONDER-TONGUE A-105-HI-LO COUPLER. Combines low and high band VHF antennas and provides separate low and high outputs from a common line or antenna. Less than 0.5 db loss. List \$4.10

BLONDER-TONGUE A-107 UHF-VHF ANTENNA COUPLER. The choice in UHF areas throughout the country. It combines VHF and UHF antennas, or provides separate VHF and UHF outputs from a common line or antenna. Less than 1.0 db loss. List \$4.75



INDOORS OR OUTDOOR. Blonder-Tongue couplers are the easiest to install. Patented strippless connectors assure rapid, positive installation—no stripping, no splicing twinlead. Weatherproof, *non-breakable* case permits installation indoor or outdoors.



For the right coupler at the right price, contact your Blonder-Tongue parts distributor or write Dept. RE-4
engineered and manufactured by

BLONDER-TONGUE
9 Alling St., Newark, 2 N. J.

Canadian Div: Benco Television Assoc., Ltd., Tor., Ont.
home TV accessories • closed circuit TV systems
UHF converters • master TV systems

EQUIPMENT REPORT

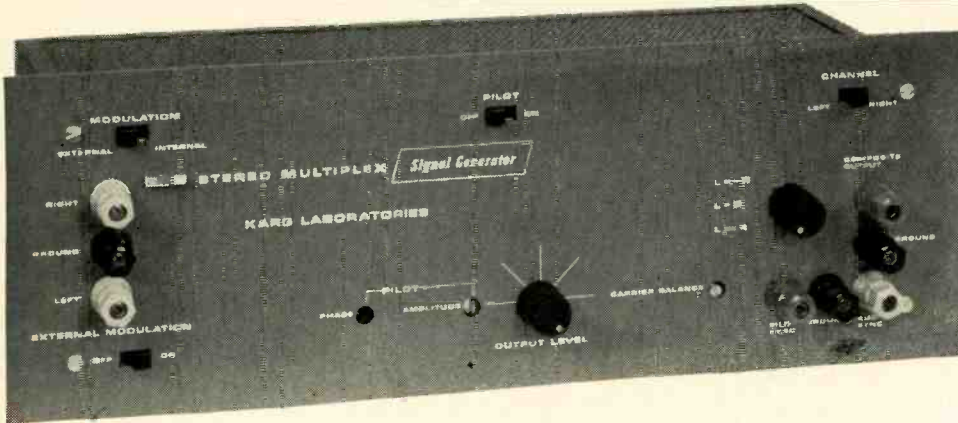

Ideal for the service technician who plans to work on FM stereo receivers

By GEORGE MORDWINKIN*

NEW LOW-COST FM STEREO GENERATOR

SERVICING FM STEREO ADAPTERS AND tuners is rapidly becoming a new field for the service technician. With the proper test equipment, such work can be handled easily and accurately. But the cost of such equipment, running from \$400 to \$1,000, is high.

To help to solve this problem, Karg Laboratories Inc. has produced the MX-1G Generator at a lower cost (approx-

* Associate engineer, Hancock Telecontrol Corp.

mately \$250). It does everything the technician needs, but uses simpler circuitry.

The MX-1G produces a composite waveform similar to the modulating signal of stereo broadcasting stations (thus such a generator can also be used as a stereo modulator for closed-circuit broadcasting in a showroom demonstration). The composite waveform consists of the audio signal sampled at 38 kc and

the 19-kc pilot signal at an amplitude 10% that of the total signal.

The generated signal can be applied in three ways:

1. *Right or left channels only.* This signal is the one most important to the service technician, because it allows him to adjust for maximum separation between channels.

2. *Right and left channels fed simultaneously with the audio signal at the same phase ($R = L$).* This condition simulates a monaural signal.

3. *Right and left channels fed simultaneously with audio signals at 180° ($R = -L$).* This signal is usually used to check the balance of both channels.

The amplitude of the 19-kc pilot is usually 10% of the composite signal, but can be decreased to determine the minimum pilot-signal level that will sync the local oscillator. The stability of the local 19-kc oscillator can be checked after alignment by switching off the 19-kc pilot from the generator.

A block diagram of the multiplex generator is shown in Fig. 1. The 19-kc oscillator is a conventional crystal-controlled type. As you can see from the schematic (Fig. 2), it uses a twin triode (V2). The primary of transformer T2 is connected to the plate circuit of the second triode and tuned to 19 kc by capacitor C2. Its core is adjusted for maximum amplitude.

T2's secondary feeds a phase-shift network which produces variable (0° to 90°) phase shift. This network is varied by potentiometer R7.

When switch S4 is OFF, it disconnects the 19-kc pilot from the composite output waveform. When it is ON, the 19-kc pilot feeds the cathode-follower stage, where R9 controls the amount of

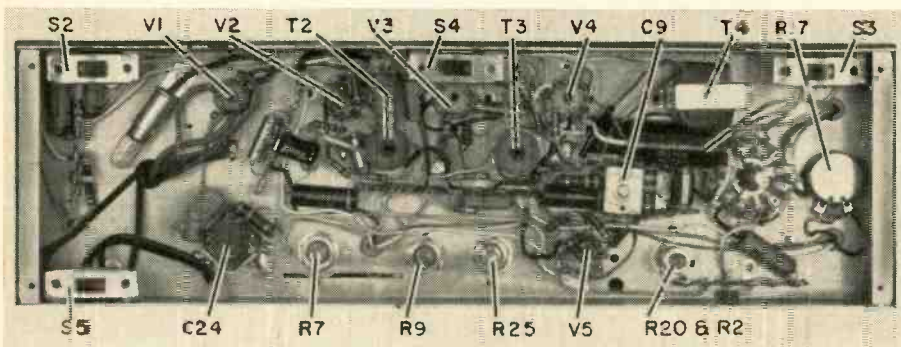

Removing front panel reveals bottom of chassis.

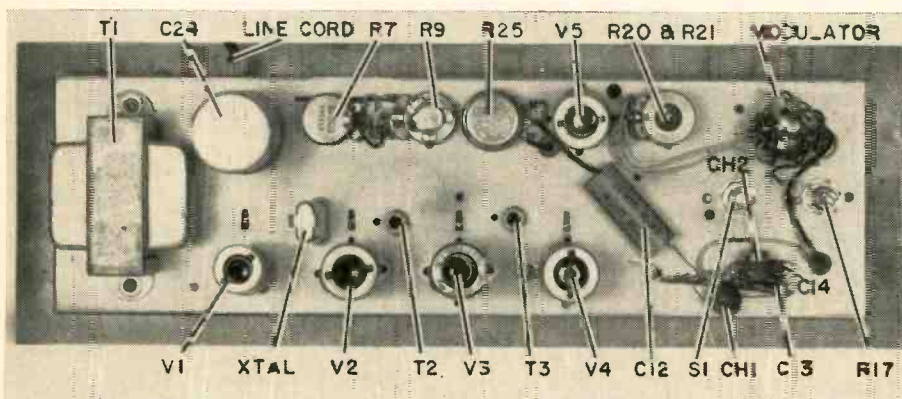

Top of chassis with major components identified.

pilot signal in the output signal (relation of the 19-kc amplitude to the composite signal amplitude).

V3-b, the audio oscillator (approximately 1 kc), produces the audio frequency for modulation purposes. It is a phase-shift oscillator using a plate transformer. The secondary of this transformer delivers split-phase balanced output. The two phases are then applied to the cathode followers (V4) to match the low impedance of the modulator.

If frequencies other than the internal 1-kc tone are desired for testing, connect an external audio oscillator to the EXTERNAL MODULATION terminals on the front panel. S2 disconnects the internal audio source and connects the terminals for the external audio into the circuit. The same terminals are used to modulate the generator with stereo program material.

Outputs from cathode followers V4 are applied to S1, the MODE SELECTOR. In position 1, S1 in combination with S3 feeds right or left channels of the modulator. In position 2, S1 feeds both channels the same signal in the same phase. In position 3, S1 feeds both channels the same signal, but 180° out of phase.

The modulator is basically an eight-

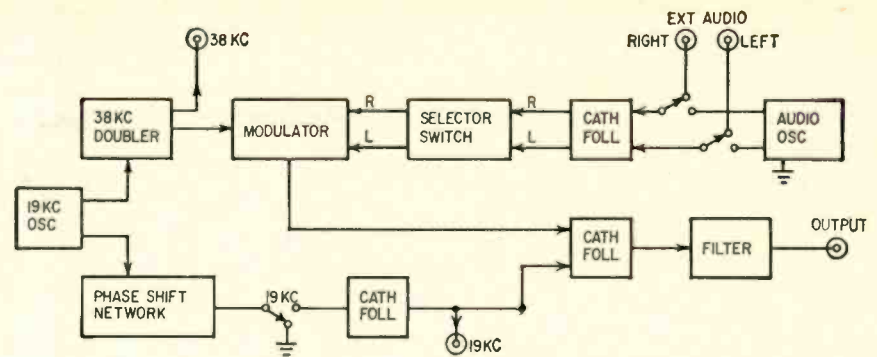

Fig. 1—Block diagram of the stereo generator.

diode gate. The audio signals are sliced at 38 kc and then mixed into one composite signal. The dual potentiometer (R20-R21) controls the dc level of the both channels to correct the symmetry of the waveform.

The 38-kc subcarrier is applied to the modulator from T3's secondary. C8 tunes T3's primary to 38 kc and this tank circuit is connected to V3-a's plate.

The grid of this doubler tube is connected through C7 to T2's secondary, which feeds the 19 kc. For synchronizing a scope, there are two test jacks on the front panel—one for audio

and the other for the 19-kc pilot frequency.

The output circuit consists of a cathode-follower stage and filter. The output signal level is controlled by R25, which serves as partial cathode resistor of the output stage. C9 takes care of phase compensation for the high-frequency signal component. R17 in the modulator circuit is used to balance the 38-kc signal.

The 19-kc (PILOT SYNC) test jack can also be used to inject the SCA carrier. When SCA carrier is applied, S4 should be OFF, so the 19-kc pilot does not appear in the output waveform. END

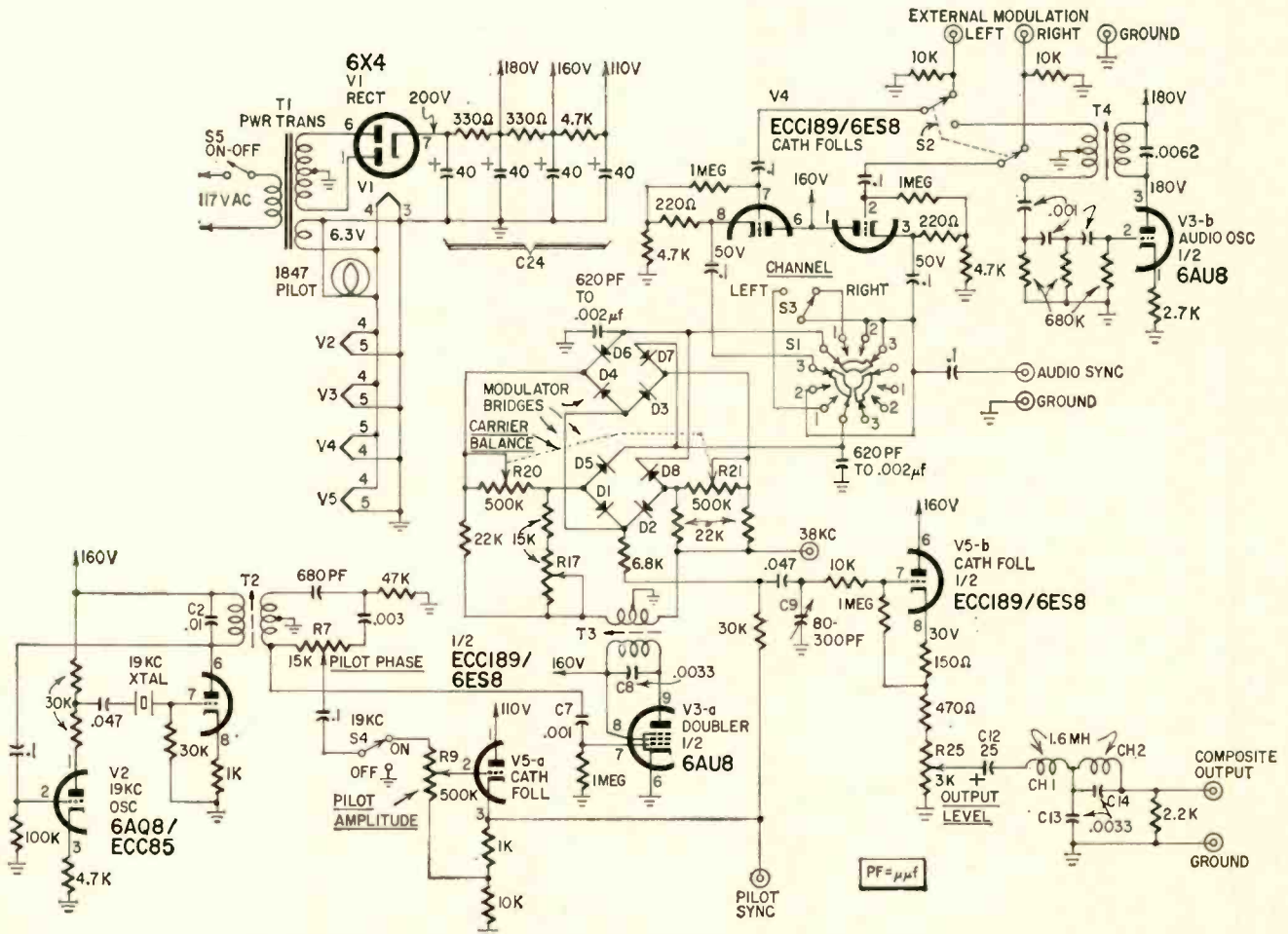

Fig. 2—Circuit of the Karg Labs MX-1G FM stereo generator.

Only Sylvania receiving tubes



LIFE-BOOST* CATHODE...a big bonus in tube quality

Sylvania's exclusive LIFE-BOOST Cathode is putting new life into tubes—and sales. This latest evidence of Sylvania leadership in tube technology offers benefits you can really sell: it virtually eliminates performance slump, a major cause of profit-stealing callbacks. Besides stability, it produces significantly better tube life and uniformity. More than 90 types already have LIFE-BOOST, with more on the way...and it's being heavily promoted in national magazines and by mail. *Trademark

give you these 2 big bonuses:

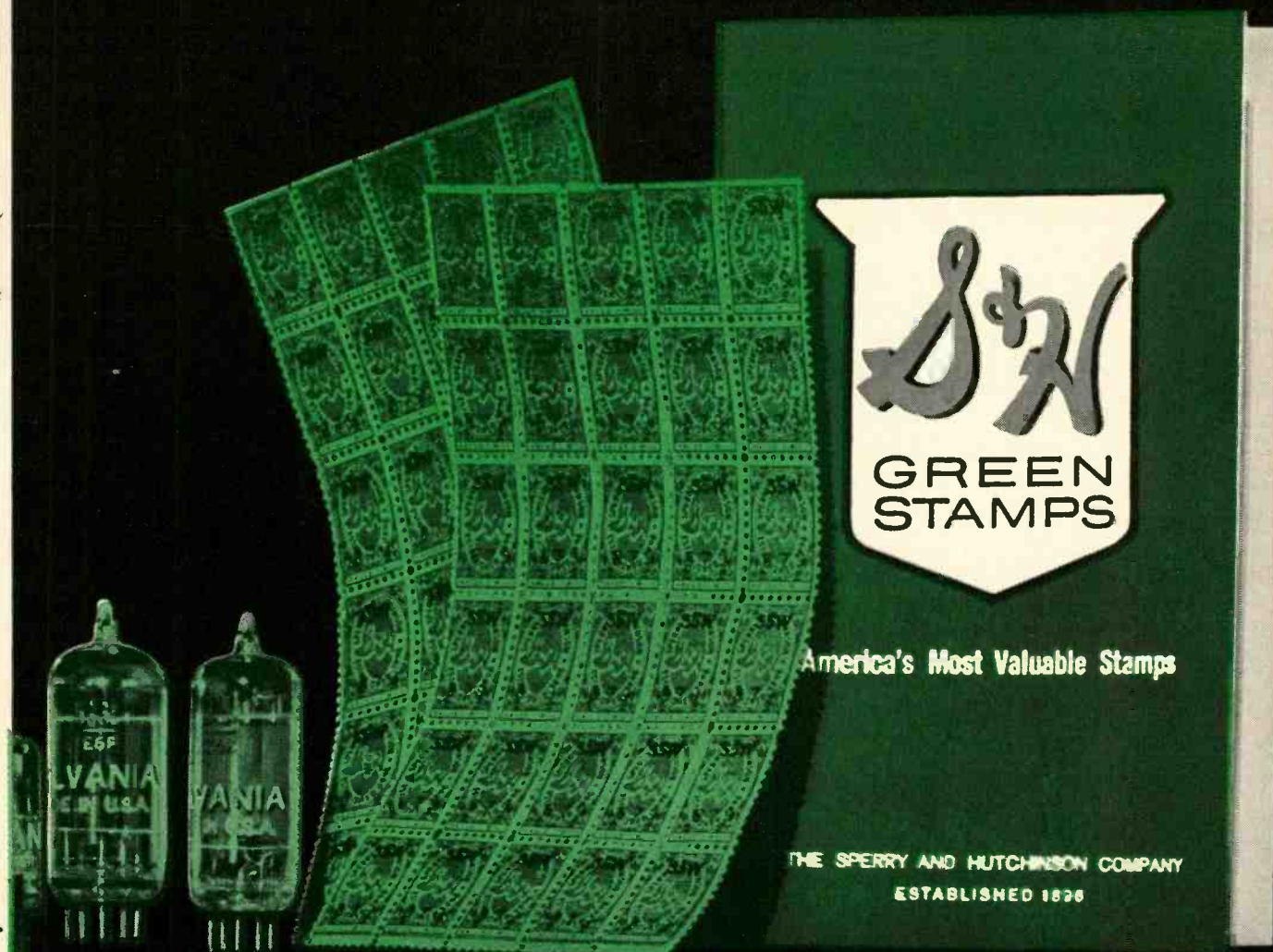

S&H GREEN STAMPS...with the Service 'n Save Plan

Here's another big reason to go with Sylvania. S&H Green Stamps, exclusive with participating Sylvania Distributors, are given free to dealers with the purchase of Sylvania receiving tubes. They add up fast, especially when they're combined with stamps from the grocer and other merchants who give S&H Green Stamps. And the family can select gifts from a 144-page S&H Catalog full of everything from home furnishings to furs.

GO WITH SYLVANIA—TO PROFIT!

SYLVANIA

SUBSIDIARY OF

GENERAL TELEPHONE & ELECTRONICS



KEEP Your Scope LINEAR... if it isn't,

it can lead to errors in TV servicing

By WM. DARRAGH

I've received several questions lately about horizontal nonlinearity in oscilloscopes. This can be annoying and sometimes causes trouble diagnosing faults.

Fortunately, nonlinearity is pretty easy to check, with only the simplest equipment. Just put a signal known to be linear on the scope and set the horizontal sweep to show about four cycles on the screen. Set the horizontal gain so that the pattern just touches both edges of the screen.

A 400-cycle audio signal from an rf signal generator, or a square wave from an audio generator, or four frames of a TV signal, taken from the video detector or video amplifier circuit are suitable (Fig. 1). If the horizontal amplifier is nonlinear, it'll promptly tell you. You'll spot crowding at one side of the pattern when it should be exactly the same all the way across. If you step back 4 or 5 feet, nonlinearity will become more apparent than if you're very close to the screen.

If the scope isn't linear, what do

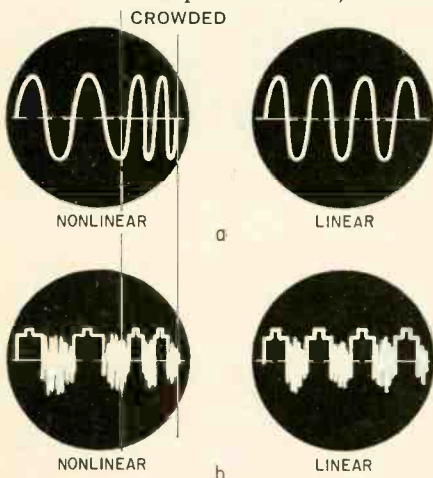

Fig. 1—*a*—Nonlinear and linear waveforms of sine-wave patterns. *b*—Nonlinear and linear waveforms of composite video patterns.

we do about it? This trouble is always caused by a fault in the scope's horizontal amplifier or oscillator. Since a scope CRT always uses electrostatic deflection, the horizontal sweep must generate a perfect voltage sawtooth and not the familiar trapezoidal waveforms of TV (Fig. 2).

Obviously, if there is anything in the scope amplifiers that will distort the voltage sawtooth, the electron beam will not be deflected at the same rate as it passes across the screen, and we'll have nonlinearity (Fig. 3). With a perfect sawtooth, the beam travels across

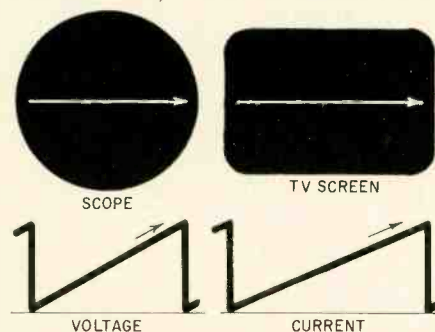

Fig. 2—Perfect sweep waveforms for scope or TV. Sawtooth voltage on scope (electrostatic) or current wave on TV (electromagnetic) deflection makes electron beam travel all the way across the screen at a constant speed.

the screen at a constant speed. With a distorted sawtooth, flattened or peaked, the speed is not the same all the way across and we've got nonlinearity.

Older scopes used single-ended horizontal and vertical deflection amplifiers, while the later and more expensive models use push-pull deflection (Fig. 4). Most of the troubles seem to be in this amplifier stage, although there is always the possibility that they're in the oscillator, so don't overlook it.

You've undoubtedly had many cases of trouble in TV sets with vertical nonlinearity. We've got the same trouble here. If you find that characteristic

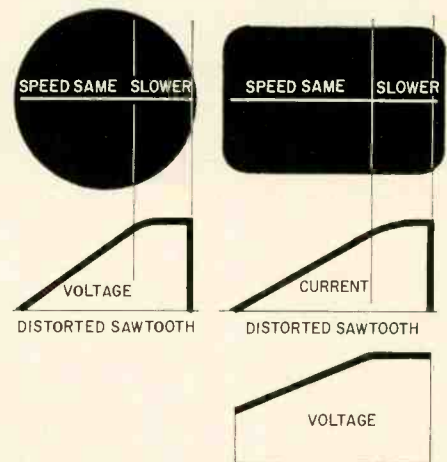

Fig. 3—Any defect that causes the sawtooth to change shape will cause nonlinearity. Flattening of the top, shown here, causes a nonlinear sweep.

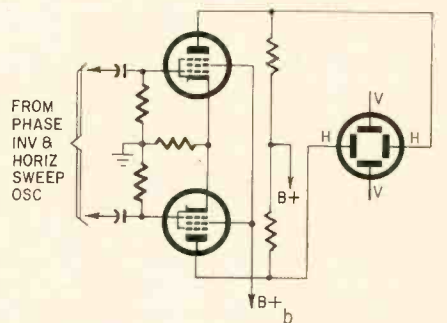
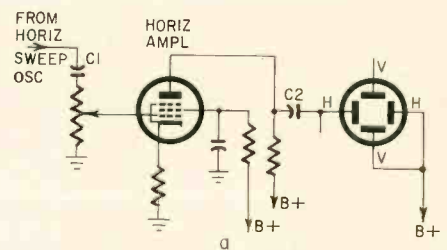
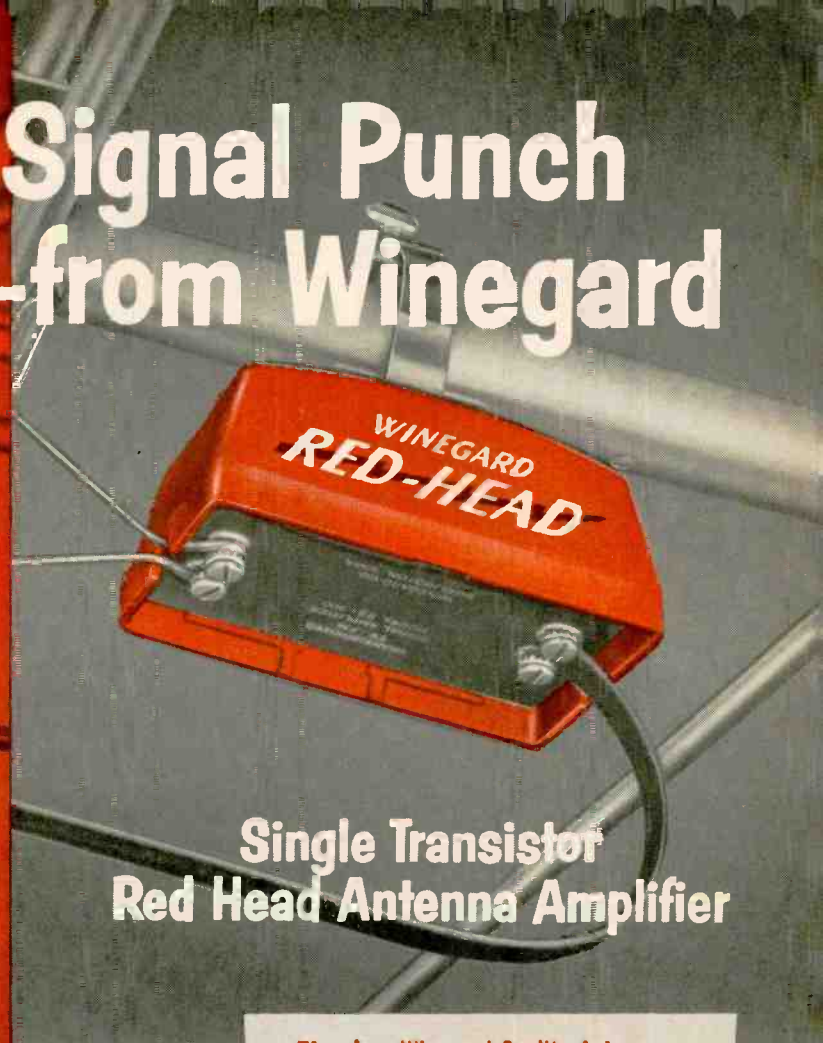

Fig. 4—*a*—Single-ended horizontal deflection stage in typical scope. *b*—Push-pull horizontal deflection stage in typical scope.

Greatest 1-2 Signal Punch in the Industry—from Winegard



**Winegard's 2-Nuvistor
Colortron Antenna Amplifiers**



**Single Transistor
Red Head Antenna Amplifier**

Take your choice of Winegard's 2-nuvistor Colortron or single-transistor Red Head antenna amplifiers—both great—both trouble-free! Both work with any TV or FM antenna. Here's the story!

COLORTRON ANTENNA AMPLIFIER . . . ONLY \$39.95 • EXCELLENT FOR COLOR • WON'T OVERLOAD • TAKES UP TO 400,000 MICROVOLTS OF SIGNAL

FINEST ANTENNA AMPLIFIER MADE . . . Because the COLORTRON amplifier takes up to 400,000 microvolts of signal input, strong local signals won't overload and cause interference on distant fringe stations. It takes 20 times more signal input than any transistor antenna amplifier and without compromising its ultra low noise ability to pull weak signals out of the snow.

A special "lifesaver" circuit gives the 2 nuvistor an expected life of 5 to 8 years. It's the only amplifier that's completely weather-proof—nothing exposed, even terminals are protected. Install it and forget it! Fits any TV or FM antenna.

Colortron Amplifiers are Available in 2 Models for TV

FORTV—Model AP-200N—twin nuvistor, takes up to 400,000 microvolts, input 300 ohm, output 300 ohm, \$39.95 list.

FOR TV—Model AP-275, twin nuvistor, takes up to 400,000 microvolts, input 300 ohm, output 75 ohm, \$44.95 list.

RED HEAD TRANSISTOR MODEL . . . ONLY \$29.95 • FOR COLOR AND BLACK & WHITE • MOST RELIABLE TRANSISTOR ANTENNA AMPLIFIER EVER MADE.

With the Red Head, you won't have transistor "pop-out" because of its special advanced circuit that protects against lightning flashes, precipitation static and power line surges. Has high pass interference filter, 2-set coupler, fully AC—no polarity problems. Tremendously effective in remote areas where all signals are less than 20,000 microvolts. Uses latest low noise MADT transistor. Bright red amplifier housing gives lasting product identification. The Red Head supersedes Winegard's famous MA-300 amplifier.

For TV or FM—Model No. RD-300, single transistor, takes up to 20,000 microvolts, 300 ohm input and output, \$29.95 list.

Stereotron Amplifiers are Available in 2 Models for FM

FOR FM—Model AP-320, twin nuvistor, takes up to 200,000 microvolts, input 300 ohm, output 300 ohm, \$39.95 list.

FOR FM—Model AP-375, twin nuvistor, takes up to 200,000 microvolts, input 300 ohm, output 75 ohm, \$44.95 list.

Write for technical data or ask your Winegard distributor.

**There's a Winegard Quality Antenna
for Every Reception Need**

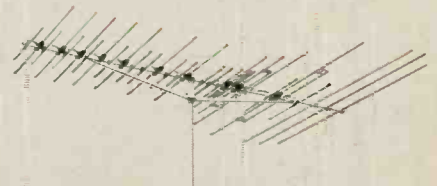

**COLORTRON ANTENNA
Model C-44 • Gold Anodized • \$64.95**

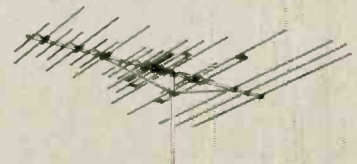

**COLORTRON ANTENNA
Model C-43 • Gold Anodized • \$51.90**

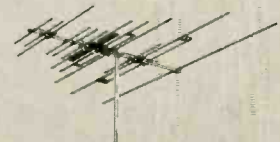

**COLORTRON ANTENNA
Model C-42 • Gold Anodized • \$34.95**

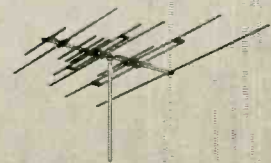

**COLORTRON ANTENNA
Model C-41 • Gold Anodized • \$24.95**



YOU GET AN EXTRA BONUS OF QUALITY AND VALUE FROM WINEGARD

Winegard ANTENNA SYSTEMS

WINEGARD COMPANY • 3013-4 KIRKWOOD BLVD. • BURLINGTON, IOWA

ALL NEW!



EMC advances in Audio and Test Equipment — by far the Best Values obtainable in Wired or Kit form.

EMC Model 801 RC Bridge and In-Circuit Capacity Checker

A new comprehensive resistance and capacity checker. It measures condensers for actual value, leakage, and power factor. In addition it measures condensers while still connected in their original circuits for opens, shorts or intermittents.



Model 801 Wired\$38.95 — Model 801 Kit\$24.95

EMC Model 802 Signal Tracer and Generator

Generates its own audio, IF and RF signal for tracing. Uses both a magic eye tube and a speaker for signal detection. Checks noisy components. Checks and compares magnetic, ceramic and crystal cartridges. Supplied with two shielded audio probes and RF crystal demodulator probe.



Model 802 Wired\$38.95
Model 802 Kit\$24.95

EMC Model 107A Peak to Peak Vacuum Tube Volt-Ohm Capacity Meter

6" meter cannot burn out — entirely electronic. Measures peak to peak AC voltages to 2800 volts in 6 ranges. Measures capacity in 6 ranges from 50 mmfd to 5000 mfd. Measures resistance in 6 ranges from .2 ohm to 1000 megs. Measures DC volts to 1000 volts in 6 ranges. Input resistance 16.5 megs.



Model 107A Wired\$51.40 — Model 107A Kit\$36.50

EMC Model 214 Stereo Amplifier

A compact, highly attractive dual 14W amplifier with built in preamplifiers having 56 watts peak power output. Has rumble filter and contour control switch. Extremely low distortion and noise level. It can be used as a 28 watts (56 watts peak) monaural amplifier or as a monaural amplifier so arranged that one pre-amplifier is used to drive the internal amplifier while the other preamplifier is used to drive any existing monaural amplifier.

Model 214 Wired\$106.80 — Model 214 Kit\$68.90

Yes, tell me more, send me **FREE** a detailed catalog of the Complete EMC Line. Dept. RE-463

NAME
STREET
CITY STATE

EMC Electronic Measurements Corp.
625 B'way, New York 12, N. Y.
Ex. Dept., Pan-Mar Corp., 1270 B'way, New York 1, N. Y.

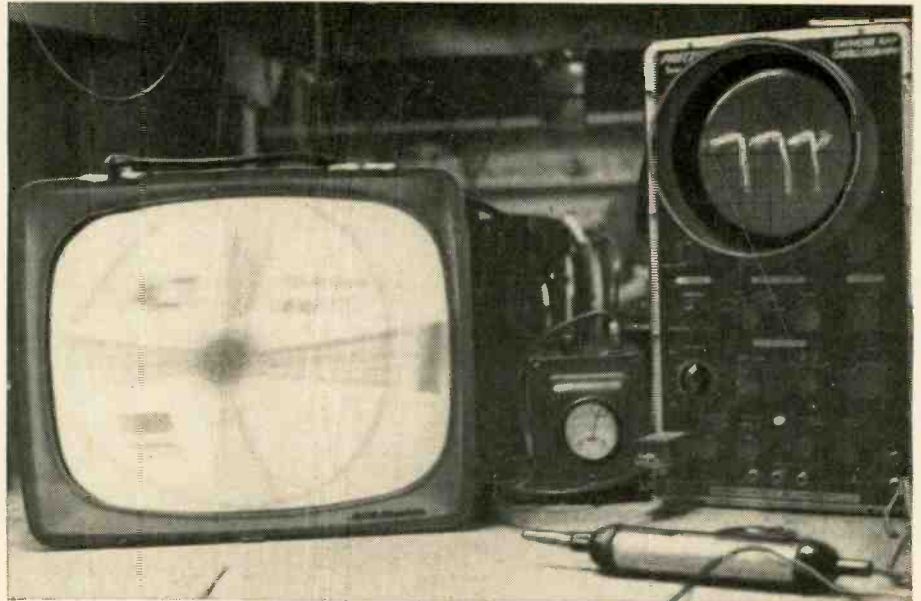

The scope on this bench is displaying a square wave with severe compression on the right edge of the screen.

flattening of the top of the sawtooth, there is the cause of your nonlinearity. So check the same things—plate load resistors for a change in value, especially in push-pull stages. If a load resistor changes too much, our tube won't be operating on the linear portion of its E_p/E_c curve, and our "saw" gets very dull. Even the slightest dc leakage through a coupling capacitor will throw the stage off the proper place on the curve. Bias voltages are very important too. They determine the operating point of the stage. Therefore, check all resistors and capacitors for leakage and value. In most commercial circuits you won't normally find the cathode bypasses used in TV sets; but you might, so check the schematic carefully. A defective cathode bypass would be an excellent place to find linearity troubles.

While the relaxation oscillators

used in most commercial scopes, especially the older models, do not seem to cause too much of this kind of trouble, it's a good idea to check them while you've got the instrument out of the case! There isn't too much to the circuit: a plate load resistor; grid resistor, sometimes two, and the cathode resistor with its bypass capacitor. Check the grid resistors and cathode resistor closely for any signs of increase in value. This would cause an increase in grid bias, and increasing the bias above "normal" is one of the easiest ways to make this type of oscillator get very highly nonlinear!

Also, in difficult cases, check the supply voltages. Be sure they are very close to what the schematic calls for. If the supply voltage to a relaxation oscillator is below normal, the first result is nonlinearity. Since we're trying



Trying to service with a scope waveform like this is impossible. It is so badly distorted that the technician won't be able to tell whether there really is a fault in the TV or not.

to deal with scopes in general here, rather than one specific model, we can't give definite voltages. However, they will always be found in the instruction book.

If another scope is available, waveforms can be checked at each point in the circuit, beginning with the horizontal oscillator. However, this is not essential. The pattern on the screen will give you all the information you need.

Oh, you did check the tubes, didn't you? If not, you certainly should have. A weak tube will cause this kind of trouble very quickly. If it isn't able to put out its full normal output, the curve will definitely be flattened on top. It's a good idea to try one or more tubes in this circuit, even though they are all

new ones. We just avoided a long and tedious service job on one occasion by substituting a second new tube. It seems that there was something wrong with the first new one.

If a square-wave generator is on hand, check the vertical circuits at the same time. Watch for tilt, high- and low-frequency response and things like that, as well as nonlinearity. In fact, while you've got the thing out of the box, it would be a good idea to go over it thoroughly. Check power supplies, tubes, clean controls with a spray cleaner, look for signs of corrosion on the high-voltage rectifier socket, and give it a "going over" in general. There is nothing quite so annoying as a service instrument that doesn't work just right! END

These are the answers.
Puzzles are on page 44.

WHAT'S YOUR EQ?

Time constant

The maximum voltage the capacitor sees is the steady-state dc voltage of 50 across R2. Using Thevenin's theorem, the resistance that the capacitor sees is between points A and B, looking back into the circuit with the source shorted,

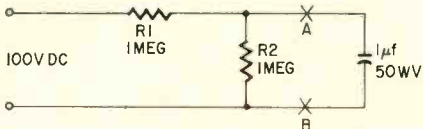

or the equivalent of R1 and R2 in parallel, or 500,000. Note the circuit is broken at points A and B when determining the Thevenin equivalent resistance.

How much voltage?

1. E across the two capacitors = $0.9E_{in} - 0.6E_{in}$
2. E across the 1-μf capacitor = $2/3(0.9E_{in} - 0.6E_{in})$
3. E across the 10,000-ohm resistor = $0.1E_{in}$
4. $2/3(0.3E_{in}) - 0.1E_{in} = 10$
Therefore, $E_{in} = 100$ volts dc.

That Resonant Problem

The capacitor voltage is maximum at resonance and equal to Q times the input voltage, E. The resonant frequency is $0.159/\sqrt{LC} = 159$ cycles. The inductive reactance at resonance is $2\pi fL = 1,000$ ohms. The circuit Q at resonance is $Q_r = X_L/R = 100$. There-

fore the peak voltage the capacitor must withstand is $QE = 100$ volts.

Series resistor circuit

The solution is:

$$(A) \frac{E \times R_2}{R_1 + R_2} = 24$$

$$(B) \frac{E \times R_2}{R_2 + \frac{100 \times R_1}{R_1 + 100}} = 40$$

$$(C) \frac{E \frac{100 \times R_2}{R_2 + 100}}{R_1 + \frac{100 \times R_2}{R_2 + 100}} = 20$$

$$(2C = B) \rightarrow 200R_2E = 100R_2E + R_1R_2E \rightarrow R_1 = 100 \text{ ohms.}$$

$$(A) \rightarrow R_2E = 24R_2 + 2,400$$

$$(B) \rightarrow R_2E = 40R_2 + 2000$$

$$24 \times R_2 + 2,400 = 40R_2 + 2,000 \rightarrow R_2 = 25 \text{ ohms.}$$

$$(A) \rightarrow 25E = 2,400 + 600 \rightarrow E = 120v.$$



Gesundheit!

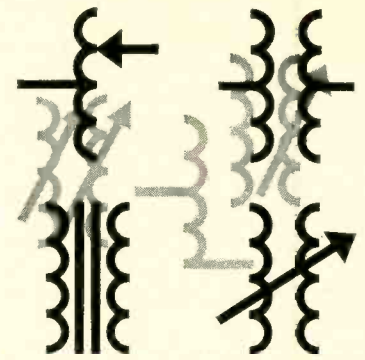

TRIAD THE COMPLETE LINE OF QUALITY TRANSFORMERS

Triad makes transformers of all types for home, laboratory, or service shop. Industrial and amateur types include audio, chokes, filament, instrumentation, modulation, output, and transistor. For television replacement needs, there are yokes, flybacks, and powers to fit nearly every make and model. Specifications and prices are listed in Triad's Industrial Transformer Catalog and Replacement Transformer Catalog. To obtain a copy of either one, see your distributor or write Triad Distributor Division, 305 North Briant Street, Huntington, Indiana.

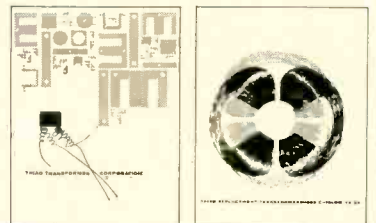

T TRIAD DISTRIBUTOR DIVISION
A DIVISION OF LITTON INDUSTRIES

NOW! PHOTOFACT®—BETTER THAN EVER—

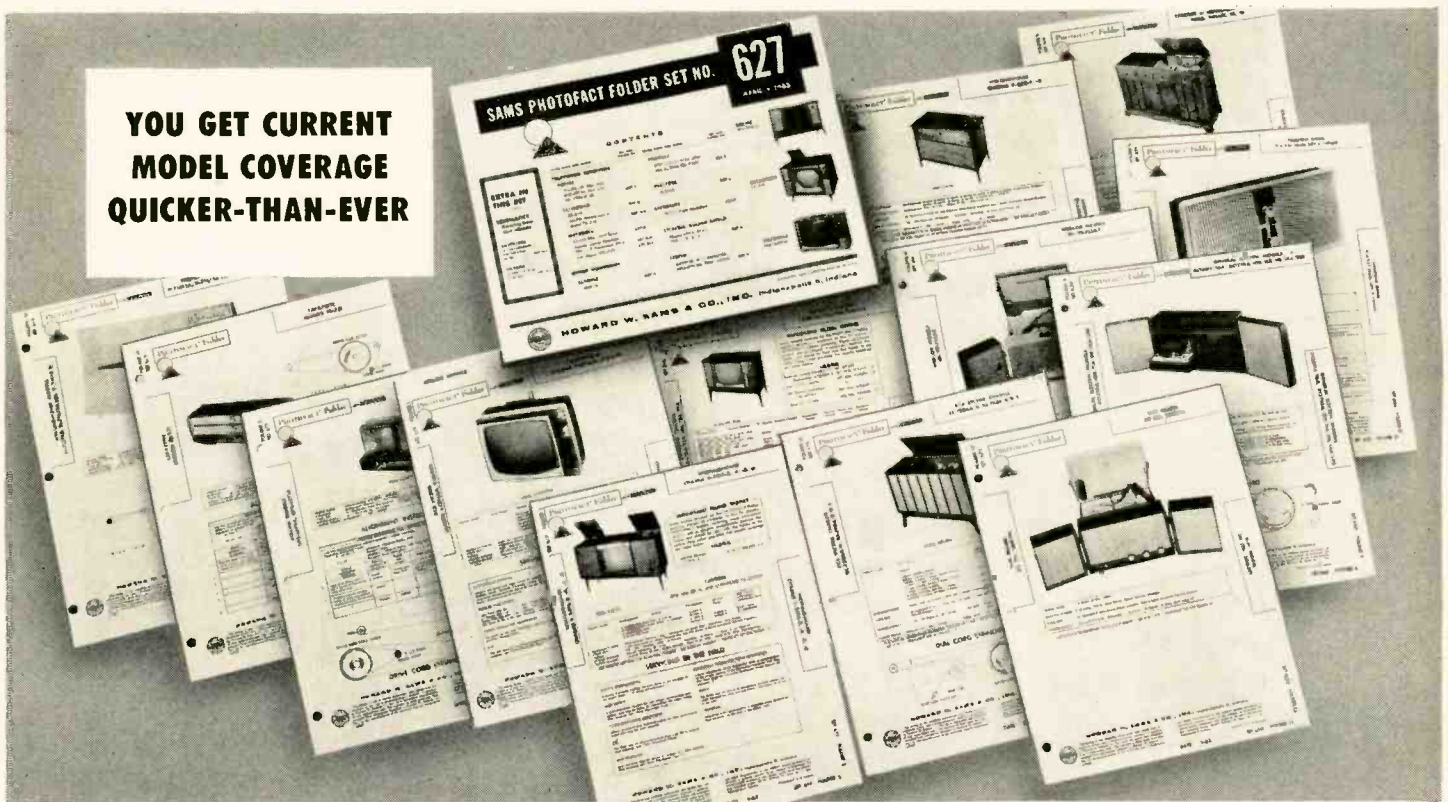

**YOU GET CURRENT
MODEL COVERAGE
QUICKER-THAN-EVER**

Now! More TV Coverage in Every PHOTOFACT Set More coverage of the type of equipment you service most!

- MORE TV COVERAGE
- MORE AC-DC COVERAGE
- MORE AM-FM COVERAGE
- MORE HI-FI COMBINATIONS
- MORE RECORD CHANGER COVERAGE
- MORE PHONOGRAPH COVERAGE

**SEND
COUPON**

HOWARD W. SAMS & CO., INC.

Howard W. Sams & Co., Inc., Dept. 6-D3A
4300 W. 62nd St., Indianapolis 6, Indiana

- Enter my Photofact Standing Order Subscription
 Send full information on money-saving Easy-Buy Plan

My Distributor is: _____

Shop Name _____

Attn. _____

Address _____

City _____ Zone _____ State _____

UP-TO-THE-MINUTE COVERAGE KEEPS YOU AHEAD

Here it is—beginning with April releases—quicker service data coverage for more of the kind of equipment you most frequently repair. And it's the same famous PHOTOFACT time-saving, troubleshooting help—*everything* you need to earn more daily. You get: Exclusive Standard Notation Schematics packed with all the service details you need; full photo coverage of all chassis views; complete replacement parts lists, tube placement diagrams; actual waveform photos; CircuiTrace® for printed boards; alternate tuner data; terminal identification and connections; disassembly instructions; field servicing notes; dial cord stringing diagrams—plus dozens of other great features. Take the *right* step to time-saving, profit-building servicing—see your Sams Distributor for details on an Easy-Buy PHOTOFACT Library and Standing Order Subscription—or send coupon today!

**SAVE 30¢
PER SET!**

SIGN UP TODAY FOR A MONEY-SAVING PHOTOFACT STANDING ORDER SUBSCRIPTION!

With a Standing Order Subscription to receive PHOTOFACT regularly each month as issued, you pay only \$1.95 per Set instead of the regular \$2.25 price. You save 30¢ per Set—and you keep right up with the rapidly-increasing current model output! You enjoy the same 30¢ per Set savings when you purchase an Easy-Buy PHOTOFACT Library. Take advantage of substantial savings—sign up for a Standing Order Subscription or Easy-Buy Library with your Sams Distributor, or send coupon now for full details.

SAVE WITH A STANDING ORDER SUBSCRIPTION!

WITH ALL THE DATA COVERAGE YOU WANT!

NEW PHOTOFACT SERIES FOR SPECIALIZED SERVICING

Here's timely service data coverage on specialized equipment—complete, uniform, authoritative PHOTOFACT service data now available only in handy bound-volume form. Take advantage of our money-saving Standing Order Subscription offer for any of the Specialized PHOTOFACT Series described below.



New Auto Radio Series

Six to eight of these bound volumes issued each year, to bring you complete PHOTOFACT service data coverage of Auto Radios. Each volume covers 40-50 popular late models. Regular price per volume, \$2.95—only \$2.65 when purchased on a Standing Order Subscription—you save 30¢ per volume!



New Transistor Radio Series

Twelve to fifteen of these volumes issued each year—complete PHOTOFACT coverage of Transistor Radios. Each volume covers 40-50 popular late models. Regular price per volume, \$2.95—only \$2.65 when purchased on a Standing Order Subscription—you save 30¢ per volume!



New Tape Recorder Series

Two volumes issued yearly, to bring you complete PHOTOFACT coverage of all important, late model Tape Recorders. Regular price per volume, \$4.95—only \$4.65 when purchased on a Standing Order Subscription—you save 30¢ per volume!



New CB Radio Series

Two to three volumes issued yearly—complete PHOTOFACT coverage of all popular CB Radio models. Regular price per volume, \$2.95—only \$2.65 when purchased on a Standing Order Subscription—you save 30¢ per volume!

SEND COUPON

SAVE 30¢ PER VOLUME

SIGN UP TODAY FOR A STANDING ORDER SUBSCRIPTION TO THE PHOTOFACT SPECIALIZED SERIES

With a Standing Order Subscription to receive the new PHOTOFACT Specialized Series of your choice as issued, you pay only \$2.65 for the Auto Radio, Transistor Radio and CB Radio Series, instead of the regular \$2.95 price; only \$4.65 for the Tape Recorder Series, instead of the regular \$4.95 price! Get the world's finest specialized servicing data and enjoy extra savings with a Standing Order Subscription. Sign up with your Sams Distributor, or send coupon now.

SAVE WITH A STANDING ORDER SUBSCRIPTION!

HOWARD W. SAMS & CO., INC.

Howard W. Sams & Co., Inc., Dept. 6-D3B
4300 W. 62nd St., Indianapolis 6, Indiana

Enter my Standing Order Subscription for the following:

Auto Radio Series CB Radio Series
 Transistor Radio Series Tape Recorder Series

My Distributor is: _____

Shop Name _____

Attn. _____

Address _____

City _____ Zone _____ State _____

**OUTSELLS, OUTLASTS,
OUTHEATS
THEM ALL**

Model 250—standard of the electronics industry. Choose from 4 models—100 watt to 250 watt. All heat in 2½ to 5 seconds. Built-in spotlights focus on work. \$5.95 to \$15.95.

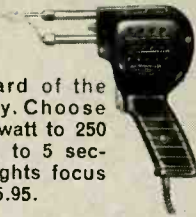

**WORLD'S FIRST
PROFESSIONAL
ELECTRIC PLANE
UNDER \$50**



Model 930

\$44⁹⁵

**NEWEST IN
THE WEN FAMILY
OF FINE TOOLS**

For edge and surface work. Souped up ½ HP motor drives cutters 14,500 RPM.



**Model 909
"All Saw"**
America's fastest selling saw.

Model 808 Drill
2-speeds plus
⅜" Jacobs chuck.

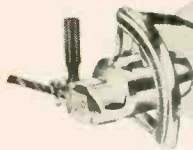
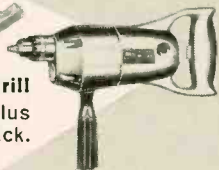

**Model 920
"Zipp Saw"**
Great on the job and for awkward cuts.

**Model 202
Sander**
For fine finishing in wood, plaster.

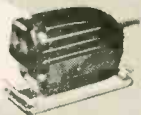

**Model 910
Belt Sander**
For any sanding job.

WEN

PRODUCTS, INC.
5810 Northwest Highway,
Chicago 31, Illinois

NEW PRODUCTS

SOLID-STATE LINEAR SAWTOOTH GEN.

Model L35G generates time variable sawtooth voltage function with constant slope, linear to .1% over voltage rise. Seven selectable full-scale time periods 100 μsec-100 seconds. Each full scale period has vernier adjustment for 1,000 discrete divisions. *Model L35G-1* provides for any single full-scale time period 100 μsec-100 seconds, 1,000-division vernier. Both units self-compensating, stable periods and slope linearity for temperature and line voltage variations. Mode selector switch pro-



vides free-running repetitive sweep or external triggered sweep. Voltage swing 0 to +10; temperature -20°C to +70°C; period resolution 1 part in 1,000 min. period on lowest range 10 μsec; power requirements +25 v ±10%, 50 ma, -5 v ±10% 10 ma. Output impedance 100,000 ohms.—Waddell Dynamics, Inc., 5841 Mission Gorge Rd., San Diego 20, Calif.

CONSTANT VOLTAGE DC POWER SUPPLY, Model RPS-5. Continuously variable, delivers any voltage to 30 vdc. For applications up to 4 watts. Zener-regulated transistorized circuit maintains constant voltage with no overshoot over wide load variation. Panel light indicates short circuit. Reads output in ranges 0-1.5, 0-15, 0-30 v;



reads load current in 0-30, 0-150 ma ranges. Current metering does not affect output impedance. Special bias taps 0-1.5 and 0-7.5 v provided for simultaneous use with main supply. Regulation .5% average (1% max.) to load, .5% to line. Output impedance 1 ohm; meter accuracy 2% full scale; response time 2 μsec.—Seco Electronics, Inc., Dept. 164, 1201 S. Clover Dr., Minneapolis 20, Minn.

ELECTRONIC REMOTE CONTROL SYSTEM, Atomaid. Allows remote operation of any appliance from any other place in house, basement or garage, by plugging "T" and "R" units

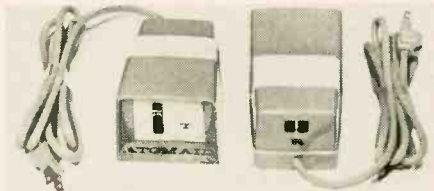

into 110 volt outlets. No additional wiring. Power handling capacity 1 kva.—Gentronics, 3224 16th Ave. W., Seattle 99, Wash.

VIBRATION PICKUP, Model 61CP. Withstands temperatures -40°F-180°F, 0-100% humidity. Lead zirconate titanate generating element

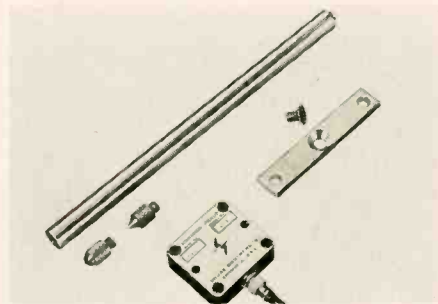
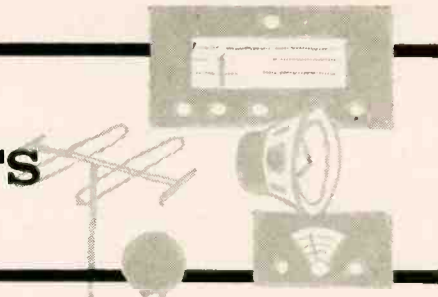

inertially actuated. May be permanently mounted or hand-held, using probe to transmit vibration. Use of probe allows measurement in temperatures above 180°F. Supplied with complete set of adapters, 8-inch extension rod, ball tip, point tip, conductor cable and mounting bracket. Output voltage directly proportional to acceleration due to vibration throughout linear range. Signal proportional to velocity from R-C integrator. Normal sensitivity on axis: 85 mv/g ±2.0 db. Cross-axis sensitivity less than 7% of on-axis sensitivity. Internal impedance 9,000 pf. Linear frequency range to 1,000 cycles. Resonant frequency 3,000 cycles ±15%. Dynamic range 100 g.—Shure Bros., Inc., 222 Hartrey Ave., Evanston, Ill.

MINIATURE TRIMMER CAPACITORS, Plus-C. Panel mount capacitors have modified anti-backlash adjustment mechanism, may be used as

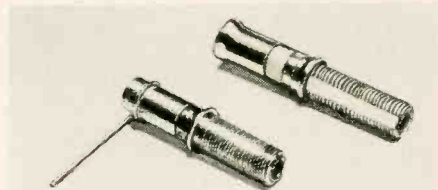

replacements for older components of corresponding part number. Gradual multi-turn adjustment, 500-cycle adjustment life. Special units available with capacitance range to 180 pf.—JFD Electronics Corp., 6101 16th Ave., Brooklyn 4, N. Y.

CONSTANT VOLTAGE AMPLIFIER, Series 9120. May be fed any frequency 20-20,000 cycles via external audio sig gen; max. continuous duty power capability 60 watts (60 volt-amps). Outputs: 120 vac at 60 watts, 28 vac at 60 watts.



Regulation 1% to 5 kc, 3% to 20 kc. Distortion at full output less than 1/10% at mid frequencies, less than 1/2% at 20 cycles and 20 kc. Response -1 db at 50 kc, -3 db at 100 kc. Drives small shaker tables, varies speed of small synchronous motors, tests aircraft instruments and equipment requiring line-voltage frequency other than 60 cycles. Power requirements 105-125 vac, 50/60 cycles.—Marantz Co., Inc., 25-14 Broadway, Long Island City 6, N. Y.

HIFI TAPE RECORDER, Model 660. 3-channel, portable unit has ac bias circuit for record, playback, erase heads. Remote control mike, earphone, batteries, cartridge, roll of tape and take-up reel. Ac adapter available as accessory. Two hours playing time; can be operated inside (Continued on page 76)



LOWER THE COST OF FUN WITH VERSATILE TARZIAN TAPE



Make a Priceless Family Heirloom—The Easy Tarzian Way

Next time the family gets together for a special occasion... and everytime a high point comes along in the lives of the children and grandchildren... be sure to record the events on long-lasting Mylar*-base Tarzian Tape. The tape will last indefinitely—and so will your pleasure—with a priceless heritage of voices and events unique to your family. Such moments can seldom be repeated, but thanks to Tarzian Tape they can always be remembered.

Double Your Pleasure With an Extra ¼ Inch

Here's good news for owners of battery-operated tape recorders. If you feel restricted by the standard 3-inch reel capacity, try the new Tarzian 3¼ inch reel for ½-mil "tensitized" Mylar* tape. Tape footage and available recording time are doubled. You get 600 feet of Tarzian Tape and one full hour of recording at 3¾ i.p.s.—compared to 300 feet and 30 minutes with the old-fashioned 3-inch reel.



Video Plus Audio

Tape recorders and Tarzian Tape pep up your movie and slide shows just as Rodgers worked with Hammerstein—good separately, outstanding together. In addition to straight commentary and music, other voices and sounds can be taped from radio and TV for use as needed—applause, traffic, etc. Speaking of taping from radio and TV, if you use a microphone try wrapping it lightly in a handkerchief to cut down on unwanted outside noise. You're even better off to eliminate the microphone. Obtain a recorder accessory cord with input plug on one end, and alligator clips on the other. The clips can be attached directly to the speaker voice coil.

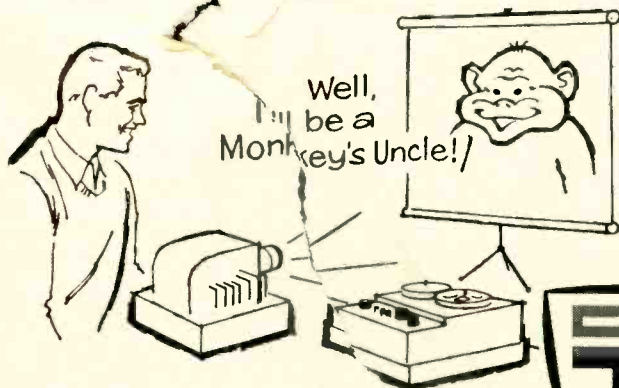

This Is Tarzian's New Tape Booklet

"Lower the Cost of Fun." It is free, useful, and distills a wealth of information on recorder and tape use and care—into 32 interesting pages. Send for your copy today, or ask for one from your local camera, high fidelity, or tape recorder dealer. Meanwhile, depend on Tarzian Tape to capture every sound with professional fidelity. Available in 1½ and 1-mil acetate, 1-mil and ½-mil Mylar—on 3, 3¼, 5, and 7-inch reels to meet every recording requirement. The price is competitive...the quality is unchallenged.

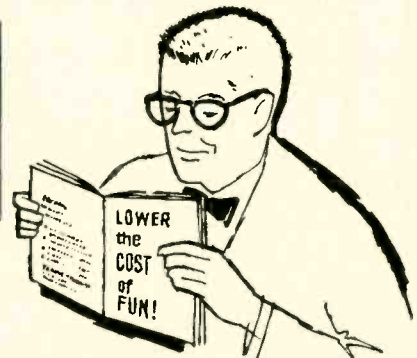

SARKES TARZIAN, Inc.

World's Leading Manufacturers of TV and FM Tuners • Closed Circuit TV Systems • Broadcast Equipment • Air Trimmers • FM Radios • Magnetic Recording Tape • Semiconductor Devices
MAGNETIC TAPE DIVISION • BLOOMINGTON, INDIANA
Export: Ad Auriema, Inc., N.Y. • Canada: E. J. Piggott Enterprises Ltd., Toronto, Ont.

RCA Training Can Be The Smartest Investment You Ever Made!



If you're considering a future in electronics, investigate the courses offered by RCA Institutes Home Study School. In the rapidly expanding world of electronics, good basic training in Electronic Theory and Practice is most important. And you can be sure of the very finest when you enroll at RCA Institutes.

Founded in 1909, RCA Institutes is one of the largest technical schools in the United States de-

voted exclusively to electronics. The very name "RCA" means dependability, integrity and scientific advance.

The courses offered by RCA Institutes are many and varied. A complete program of integrated courses for beginners and advanced students is available. They include: Electronic Fundamentals, Transistors, Television Servicing, Color Television, Electronics for Automation. Each one

is especially tailored to your needs, designed to prepare you for a profitable future in the ever-expanding world of electronics. And once you become an RCA Institutes graduate, you are assured of top recognition by leading companies everywhere.

Investigate the superb facilities for technical instruction at the RCA Institutes today. It can be the smartest move you ever made.

HOME STUDY COURSES

*in Electronic Fundamentals • TV Servicing • Color TV
Communications Electronics • FCC License Preparation
Mobile Communications • Automation Electronics
Computer Programming • Transistors • Electronic Drafting*

Voluntary Tuition Plan. All RCA Institutes Home Study courses are available under the Voluntary Tuition Plan. This plan affords you the most economical possible method of home study training. You pay for lessons only as you order them. If, for any reason, you should wish to interrupt your training, you can do so and you will not owe a cent until you resume the course. No other obligations! No installment payments required.

RCA Personal Instruction. With RCA Home Study training you set your own pace in keeping with your own ability, finances, and time. RCA Institutes allows you ample time to complete the course. Your lesson assignments are individually graded by technically trained personnel, and helpful comments are added where required. You get theory, experiment, and service practice beginning with the very first lesson. All lessons are profusely illustrated. You get a complete training package throughout the entire course.



You Get Prime Quality Equipment. All kits furnished with the course are complete in every respect, and the equipment is top grade. You keep all the equipment furnished to you for actual use on the job . . . and you never have to take apart one piece to build another.

RESIDENT SCHOOLS

*in Los Angeles and New York City—
You can study electronics in the city of your choice.*

No Previous Technical Training Required For Admission. You Are Eligible Even If You Haven't Completed High School. RCA Institutes Resident Schools in Los Angeles and New York City offer training that will prepare you to work in rewarding positions on research and production projects in fields such as automation, transistors, communications, technical writing, television, computers, and other industrial and advanced electronics applications. If you did not complete high school, RCA will prepare you for such training with

SEND POSTCARD FOR FREE ILLUSTRATED BOOK TODAY! SPECIFY HOME STUDY OR NEW YORK OR LOS ANGELES RESIDENT SCHOOL

courses specially designed to provide the basic math and physics required for a career in electronics.

Free Placement Service. RCA Institutes graduates are now employed in important jobs at military installations with important companies such as IBM, Bell Telephone Labs, General Electric, RCA, and in radio and TV stations all over the country. Many other graduates have opened their own businesses. A recent New York Resident School class had 93% of the graduates who used the FREE Placement Service accepted by important electronics companies . . . and had their jobs waiting for them on the day they graduated!

Coeducational Day and Evening Courses. Day and Evening Courses are available at Resident Schools in New York City and Los Angeles. You can prepare for a career in electronics while continuing your normal full-time or part-time employment. Regular classes start four times each year.



3 NEW LOCATIONS

In addition to RCA Institutes Inc. courses, Radio Corporation of America offers a limited selection of basic Resident School Courses in Electronics at three new locations . . . Chicago, Philadelphia, and Cherry Hill, N. J., (near Camden). For complete information, write the city of your preference next to your name on the attached postcard.

RCA INSTITUTES, INC. DEPT. RE-43 A SERVICE OF RADIO CORPORATION OF AMERICA, 350 WEST 4TH ST., NEW YORK 14, N. Y.
PACIFIC ELECTRIC BLDG., 610 S. MAIN ST., LOS ANGELES 14, CALIF.



The Most Trusted Name in Electronics

HOW TO CONVERT SURPLUS RADIO GEAR INTO AMATEUR AND C.B. EQUIPMENT

A wealth of conversion data in 3 volumes shows you how.

Data includes instructions, photos, and diagrams . . . covers the most commonly available surplus items. Each conversion shown yields a practical piece of equipment — proved by testing.

Items covered are listed below:

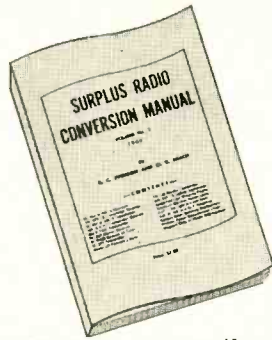

SURPLUS RADIO CONVERSION MANUALS — 3 Volumes — \$3.00* ea.

VOLUME I — ARC-5; BC-221, 224, 312, 342, 348, 412, 453/455, 457/459, 624/625, 645, 696, 946B, 1068A/1161A; PE-103A; SCR-211, 268/271, 274N, 522, 542, TBY; Electronic Surplus Index; Cross Index of A/N V.T. and Commercial Tubes. Book #315

VOLUME II — AIC; AM-26; APS-13; ARB (Schematic only); ARC-5; ART-13; ATC; AVT-112A; BC-191, 357, 375, 454, 455, 457/459, 946B, 1206; GO-9; LM; R-26-27/ARC-5; R-28/ARC-5; SCR-274N; TA-12B/12C; TBW; T-23/ARC-5; Selenium-Rectifier Power Units; Simplified Coil-Winding Data; Surplus Beam Rotating Mechanisms. Book #32C

VOLUME III — APN-1; ARC-5; ART-13; BC-191, 312, 342, 348, 375, 442, 453, 455, 456 to 459, 603, 624, 696, 1066, 1253; GBY-52000 series; GOL-43065; CRC-7; DM-34D; DY-8 or DY-2A/ARR-2; FT-241A; LM; MBF; MD-7/ARC-5; RM-52, 53; R-9/APN-4; R-28/ARC-5; RT-19/ARC-4; RT-159; SCR-274N series; SCR-508, 522, 528, 538; T-15 to T-23/ARC-5; URC-4; WE-701-A. Schematics only; APA-10; APT-2; APT-5; ARR-2; ASB-5; BC-659, 1335A; CPR-46ACJ. Book #33M

THE SURPLUS HANDBOOK (Receivers and Transceivers) — \$3.00* ea.

VOLUME I — Schematic Diagrams and large photographs only — APN-1; APS-13; ARB; ARC-4; ARC-5 (L.F.); ARC-5 (V.H.F.); ARN-5; ARR-2; ASB-7; BC-222, 312, 314, 342, 344, 348, 603, 611, 624, 652, 654, 659, 669, 683, 728, 745, 764, 779, 794, 923, 1000, 1004, 1066, 1206, 1306, 1335; BC-AR-231; CRC-7; DAK-3; GF-11; Mark II; MN-26; RAK-5; RAL-5; RAX-1; SCR-522; Super Pro; TBY; TCS; Resistor and Capacitor Color Codes; Cross Index of A/N V.T. and Commercial Tubes. Book #51H

Every Electronic Tube in the World Listed — 3 Volumes

WORLD'S RADIO TUBES (Brans' Radio Tubes Vade Mecum). World's most complete and authoritative book of v.t. characteristics. Book #47B **\$8.00***

WORLD'S EQUIVALENT TUBES (Brans' Equivalent Tubes Vade Mecum). Over 43,900 comparisons and replacements (#46W) **\$6.00***

WORLD'S TELEVISION TUBES (Brans' Television Tubes Vade Mecum). Characteristics of all TV picture and cathode ray tubes . . . also special purpose electronic tubes (#45P) **\$6.00***

NEW (16TH EDITION) RADIO HANDBOOK — the comprehensive reference source



\$9.50* Book #16R

Gives simplified theory on practically every phase of radio. Tells how to design, build, and operate the latest standard types of radio transmitting and receiving equipment. More "How-To-Build" articles than any book in the field. All data is original, up-to-date, and complete . . . clearly indexed, between hard covers. 805 pages — all text.



RADIOTELEPHONE LICENSE MANUAL

\$5.75* Book #03L

Helps you prepare for all U.S.A. commercial radiotelephone operator's license exams. Provides complete study-guide questions and answers in a single volume. Helps you understand every subject needed to obtain an operator's license.

*Order from your favorite electronic parts distributor. If he cannot supply, send us his name and your remittance, and we will supply; foreign, add 10%.

EDITORS and ENGINEERS, Ltd.

Summerland 5, California
Dealers: Electronic distributors, order from us. Bookstores, libraries, newsdealers order from Baker & Taylor, Hillside, N. J. Export (exc. Canada), order from H. M. Snyder Co., 440 Park Ave. So., N.Y. 16.



(Continued from page 70)

case.—Citroen Electronics Corp., 729 N. Highland Ave., Los Angeles 38, Calif.

GADGET GAUGE. For do-it-yourself record-player testing. Perforated card with assembly instructions forms tools to test tracking force, bearing friction, turntable level, arm set-down, stack

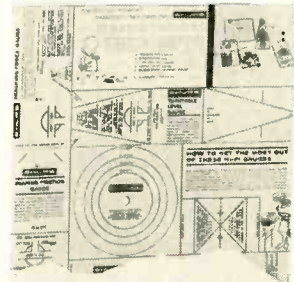

clearance, stroboscopic disc.—Shure Bros., Inc., 222 Hartrey Ave., Evanston, Ill.

STYLUS GAGE, Model SG-2. Measures tracking force any stylus/cartridge assembly 8 grams to 1/2 gram. Calibrated in 1/2-gram increments, works

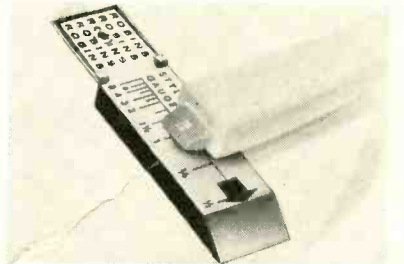

on balance principle with permanently placed counterbalance weights.—Robins Industries Corp., 15-28 127 St., Flushing 56, N. Y.

22-TRANSISTOR STEREO AMP—KIT, Model KT-900WX. Music power output 120 watts into 8 ohms, 60 watts per channel; 76 watts into 4 and 16 ohms, 38 watts per channel. Response 10–25,000 cycles ±1 db, .5% harmonic distortion at rated output. IM distortion less than 1%. Hum and

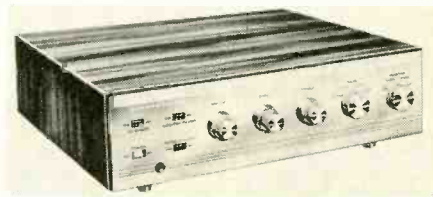

noise —68 db. Front panel controls: separate concentric bass, treble, volume; 4-position input selector, rumble filter switch, loudness control, scratch filter switch. Two ac outlets in rear. For 105–120 volts, 50/60 cycles ac.—Lafayette Radio Electronics Corp., 111 Jericho Turnpike, Syosset, N. Y.

CERAMIC MICROPHONE, Model C47D Hot Head. For CB, amateur, marine, commercial, other communications applications. Average output level —48 db over 300–4,000-cycle range. Polar pick-up pattern, differential to 600 cycles, cardi-



oid 600–4,000 cycles. Dpdt push-to-talk switch can be rewired for special applications; 3-conductor

MERCURY TV TUNER SERVICE

890-2 River Ave., Bronx 51, N.Y.

"Largest in the East"

VHF-UHF TUNERS

1 Year Warranty
Price Includes All Parts Except Tubes

ALL MAKES ONE PRICE!

\$9.50

When Shipping Tuner: Include Tubes, Shields and Damaged Parts. Give Model Number and State Complaint. PACK WELL AND INSURE. 24 HOURS ON POPULAR TYPES

Heathkit® *multiple choice test-match your hobby to a HEATHKIT*

stereo
hi-fi

Whether you are an audiophile who demands perfection or just like good music, you'll appreciate the vast selection of Heathkit stereo/hi-fi components—from source to sound—of top quality, great versatility, and big do-it-yourself savings!



ACOUSTIC SUSPENSION SPEAKER Kit version of the AR, Inc. AR-2A with genuine AR-2A speakers; 10" woofer, two 5" mid-range, 1 1/8" super tweeter. AS-2A, from \$89.95

home
entertainment

More fun, better living for your family with Heathkit intercoms, table radios, portables, garage door openers, electronic organs, TV sets, educational kits, tape recorders, automotive accessories, all at 50% savings!

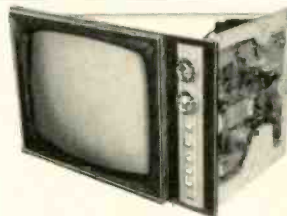

23" CUSTOM TV SET High fidelity picture and high fidelity sound to build into a wall, custom cabinet or Heathkit matching cabinet. GR-22, from \$169.95

boating

For the complete mariner, a host of marine electronic equipment for better, safer boating. Choose factory built or money-saving do-it-yourself depth sounders, direction finders, radiotelephones, tachometers, or converters by Heathkit.



25-WATT RADIOTELEPHONE for outboards! 4-channels; all-transistor receiver, 3-tube transmitter. Complete package for owner installing, with antenna and accessories, ready for 12v. battery. MWW-13-S, \$189.95

citizen's
band

For your personal two-way radio communications, Heathkit offers the world's largest selection of C-B equipment. Choose base stations, mobile stations, walkie-talkies, selective-calling sets, antennas, crystals, microphones, in all price ranges.



1-WATT WALKIE-TALKIE Range: five miles or more! Deluxe features. Best buy! Price includes \$20 rechargeable 5000 hour nickel-cadmium battery. GW-52, \$74.95 ea., \$139.95 pair

amateur
radio

Amateur radio operators around the world prefer Heathkit equipment for quality with economy. Biggest selection—transmitters, receivers, (mobile and fixed base), transceivers, plus a complete accessory line for all operation modes and all budgets.



6-METER SSB TRANSMITTER Upper or lower slide-band, AM, CW; 50-54mc in 1mc segments; 10 watts PEP; built-in VFO, VOX; easy assembly. HX-30, \$189.95

test
and
lab

Hobbyists, service technicians, and industrial users rely on Heathkit test equipment for accuracy, versatility, and economy. Choose from a complete line of meters, signal generators, oscilloscopes, tube testers, and accessories.



6" SERVICE BENCH VTVM Gimbal mount under bench, shelf, wall; 200 ua meter tilts to any angle; 7 AC/DC/Ohms ranges; universal probe. 1M-13, \$32.95

Prices & specifications subject to change without notice; dealer & export prices slightly higher

HEATHKIT

a subsidiary of Daystrom

HEATH COMPANY
BENTON HARBOR 20, MICHIGAN

Please Send My Free Heathkit Catalog

Name _____

Address _____

City _____ Zone _____ State _____



FREE 1963 HEATHKIT CATALOG
100 pages, over 250 easy-to-build kits to fit your hobby, to give you better equipment at 50% savings. Send for your free copy today.

the most noise-free recordings you have ever heard

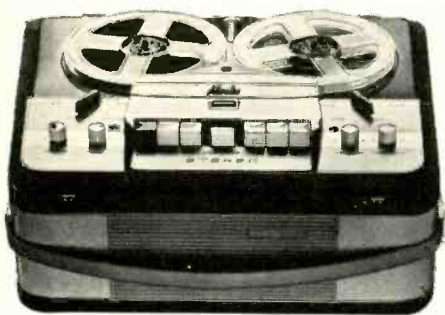

will be made on the new all-transistorized Norelco Continental '401' Stereo Tape Recorder, the only recorder using the newly developed AC107 transistors in its two preamplifiers. The AC107 is the only transistor specifically designed for magnetic tape head preamplifiers utilizing specially purified germanium to achieve the extraordinary low noise figure of 3 db, measured over the entire audio band (rather than the usual single frequency). This noise figure remains stable over large collector-emitter voltage swings and despite large variations in source resistance.

Hear the new transistorized Norelco Continental '401' • 4-track stereo/mono record and playback • 4 speeds: 7½, 3¾, 1½ and the new 4th speed of ¾ ips which provides 32 hours of recording on a single 7" reel • fully self-contained with dynamic stereo microphone, two speakers (one in the removable cover for stereo separation), dual preamps and dual recording and playback amplifiers • self-contained PA system • mixing facilities • can also play through external hi-fi system • multiplay facilities.

Specifications: Frequency response: 60-16,000 cps at 7½ ips. Head gap: 0.00012". Signal-to-noise ratio: better than -48 db. Wow and flutter: less than 0.14% at 7½ ips. Recording level indicator: one-meter type. Program indicator: built-in, 4-digit adjustable. Inputs: for stereo microphone (1 two-channel); for phono, radio or tuner (2). Foot pedal facilities (1). Outputs: for external speakers (2), for external amplifiers (1 two-channel); headphone (1). Recording standby. Transistor complement: AC 107 (4), OC75 (6), OC74 (2), OC44 (2), 2N1314 (2), OC79 (1). Line voltage: 117 volts AC at 60 cycles. Power consumption: 65 watts. Dimensions: 18½" x 15" x 10". Weight: 38 lbs. Accessories: Monitoring headset and dual microphone adapter.

For a pleasant demonstration, visit your favorite hi-fi dealer or camera shop. Write for Brochure F-4. North American Philips Company, Inc., High Fidelity Products Division, 230 Duffy Avenue, Hicksville, Long Island, New York.

Norelco®

In Canada and throughout the free world, Norelco is known as 'the Philips.'

neoprene coil cord, spring hang-up clip.—Euphonia Corp., Guaynabo, Puerto Rico.

MICROPHONE SHOCK MOUNT, Model VM-1. Has male and female ⅝-inch 27 thread for insertion between mike and stand. Made of die



castings, brass turnings, chrome finish. 4¾ x 1 in. diam.—Atlas Sound Div., American Trading & Production Corp., 1419-51 39 St., Brooklyn 18, N. Y.

CB MIKES. Response 80-7,000 cycles, output -54 db. Model 356C has hanger button and standard dash mounting bracket; 11-inch retracted, 5-foot extended coil cord, wired for relay operation. Model 254C (illus). Desk type ceramic



mike for CB base station use. Extra set of contacts allows wiring into any amateur or CB set. Touch-bar and lever-lock on-off switch.—Turner Microphone Co., 901 17 St. N.E., Cedar Rapids, Iowa.

WOOFER, Model G12P. Heavy cone stock in parabolic shape. Directional-grained, dual-diameter Alnico V magnet produces flux density equal to 21.5 oz. Alnico V as used in conven-



tional magnetic circuit. 1½-in. diam. voice coil, 4-way terminals. Response 25-1,500 cycles, peak power handling capacity 30 watts. For use with 8-ohm, 600-cycle crossover.—Utah Electronics Corp., 1124 E. Franklin St., Huntington, Ind.

8-INCH, DUAL-CONE LOUDSPEAKER, Model C-835. Profile depth 2 13/16 in. Supplementary apex radiating element integrated with primary radiating diaphragm (cone) and driving coil. SYNTAX-6 ceramic magnet. Optional 70.7- or 25-volt factory-installed transformer, KWIKON



instant connectors for input and power tap adjustment. Power rating 10 watts, response 35-18,000 cycles, 95 degree coverage angle, sound pressure level 84 db at 10 ft. for 1-watt input. Nominal impedance 8 ohms, resonant frequency 70 cycles.—Commercial Sound Products Dept., Jensen Mfg. Co., 6601 S. Laramie Ave., Chicago 38, Ill.

LAVALIER MICROPHONE, Model 560. Dual-impedance, dynamic mike may be used handheld, on floor or desk, with Model A25B Swivel Adapter. Impedance changes made by pinjack-

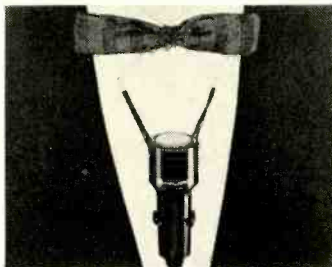

terminal setup inside case. Response 40-10,000 cycles, rising characteristics to 4,500 cycles. Omnidirectional polar pattern. Impedance: high and 150-250 ohms. Non-detachable 18 ft, 2-conductor shielded cable. Wt. 5 oz.—Shure Bros., Inc., 222 Hartrey Ave., Evanston, Ill.

PRE-WIRED WALL AND CEILING BAF- FLES. Any of manufacturer's baffles available with factory-installed speaker, matching trans-

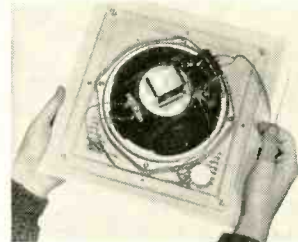

former, L-pad, on-off switch, volume control, etc. Selection of Jensen and Oaktron speakers.—Wald, Inc., 119 Prospect Ave., Burbank, Calif.

MOBILE TEACHING LAB, Vocalette. For small classes. Study groups. 12 noise-cancelling headphone/mike units for individual student use.

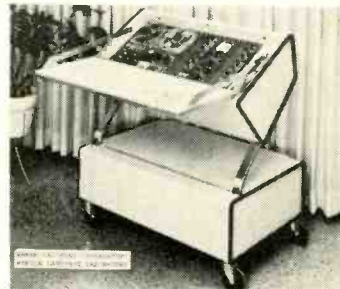

Console-type instructor's control panel has tape recorder, switch panel, student switches for 12 stations. Teacher can monitor, record and correct student practice.—Rheem Califone Corp., 5922 Bowcroft St., Los Angeles 16, Calif.

BATTERY-OPERATED STEREO TAPE RECORDER, Series 314. Portable unit for field use. Two channels for stereo recordings, independent gain adjustment. Recordings fed into any dual-channel amplifier for stereo loudspeaker playback. For single channel recording and playback, or 2-

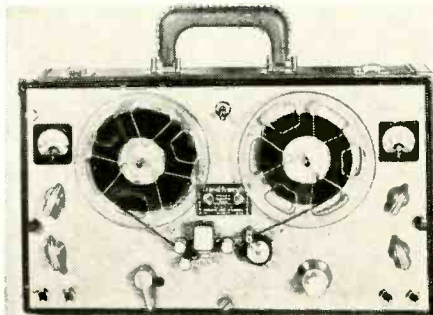

channel stereo recordings may be played non-stereo on any half-track recorder. Electric motor operates from small dry replaceable or rechargeable batteries. 22 transistors, 2 diodes, 2 isolated inputs. Separate VU meters. Multiple-shielded motor uses special auxiliary noise suppressors. Single and multi-speed models.—Amplifier Corp. of America, 398 Broadway, New York 13, N. Y.

AUTOMATIC DEMAGNETIZER for manufacturer's tape recorders, Models 997 and 1057.



Self-contained head demagnetizer used once a week eliminates residual magnetism.—Roberts Electronics, Inc. 5920 Bowcroft St., Los Angeles, Calif.

50-WATT PA AMPLIFIER, Model KN-3050. Full mixing of 4 mikes, remote mixing facilities, sockets for plug-in low-impedance mike transformers, calibrated sound level meter, separate bass and treble controls, master gain control. Balance controls for output tubes and hum; boost and cut-type tone controls; anti-feedback control, pilot light. Output jack for simultaneous recording.

Now in stock at your distributor

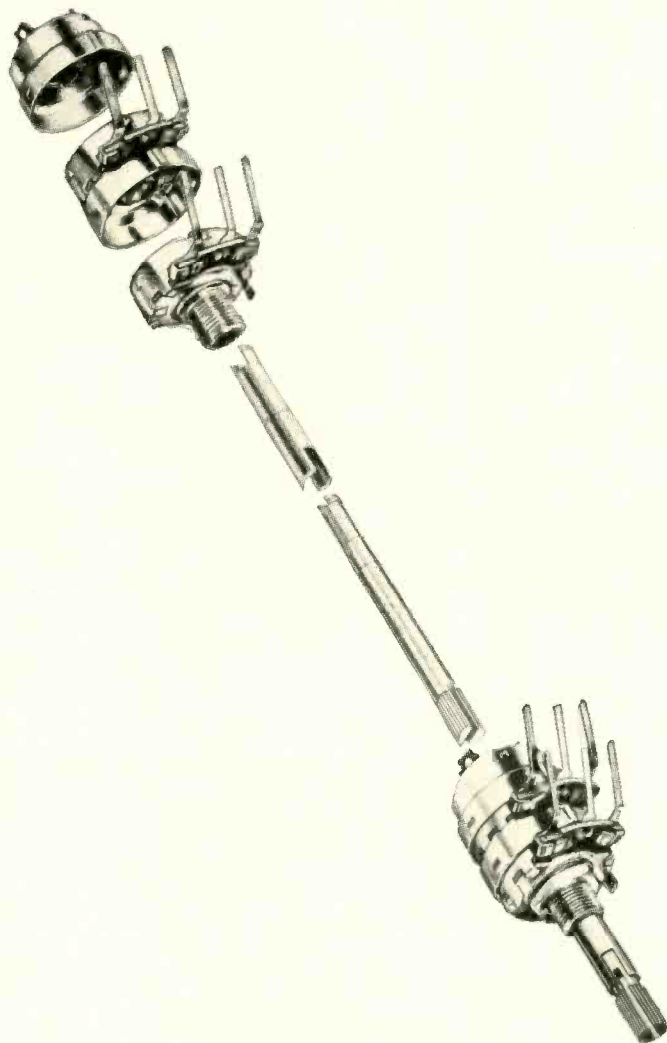

THE NEW FASTATCH® II

FROM CENTRALAB
GIVES YOU *complete instant exact replacement control coverage for dual concentric, single, and matched twin controls.*

Fastatch II gives you convenient and simple control assembly. Any control can be permanently assembled in seconds—no shaft cutting—no complicated alignment—no twisting. Just snap together and install. Your Fastatch II product will be identical to the manufacturer's original control. Check these FASTATCH II features:

- No shaft cutting . . . Exact replacement shafts are available for every application regardless of length or termination.
- Shaft won't loosen or pull out—permanent locking construction.
- Universal terminals replace all three types of printed circuit, wire-wrap and hole type terminals.
- No backlash on duals and twins.



NEW FASTATCH® II FRK-100 KIT

Everything needed to assemble an infinite variety of controls in seconds.

- 36 assorted front and rear controls in the 27 most popular resistance values
- 40 universal shafts
- 8 switches
- Current cross-reference guide
- Heavy-gauge steel cabinet.

B6308

Centralab

THE ELECTRONICS DIVISION OF GLOBE-UNION INC.
922B East Keefe Avenue • Milwaukee 1, Wisconsin
In Canada: Centralab Canada Ltd., P. O. Box 400, Ajax, Ontario

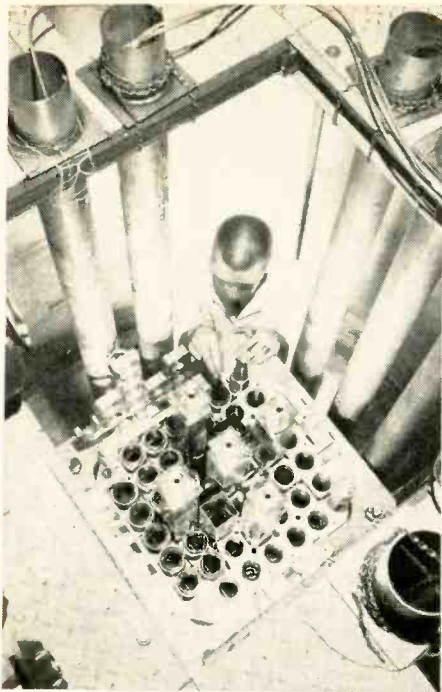

CREI can open new career opportunities for you in ATOMIC ENERGY

Exciting applications of isotopes and atomic power are creating unlimited opportunities for qualified technical personnel—particularly in such areas as nuclear instrumentation, reactor technology and health physics. CREI's free 58-page book describes these career opportunities and tells you how you can prepare to take advantage of them through a unique home study program developed by CREI.

YOU CAN QUALIFY if you have a technical background and are a high school graduate. For details, mail coupon or write: CREI, Dept. X1804-A, 3224 Sixteenth St., N.W., Washington 10, D. C.

FREE BOOK

CREI ATOMICS

A Div. of The Capitol Radio Engineering Institute
Dept. X1804-A, 3224 Sixteenth St., N.W.
Washington 10, D. C.

Please send me details of CREI Home Study Programs and Free Book, "Your Future in Electronics and Nuclear Engineering Technology." I have a technical background and a high school education.

Name _____ Age _____
Address _____
City _____ Zone _____ State _____

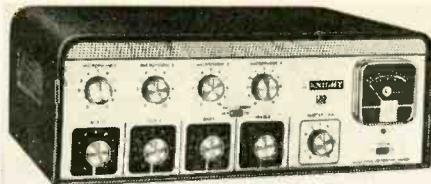

Response ± 1 db, 30–20,000 cycles at rated output. Hum and noise 75 db below rated output. Input required for rated output: mike .006 v; auxiliary .25 v; mag phono .012 v. Outputs 4, 8, 16 ohms; 25 and 70.7 volts; tape recording output. Power consumption 160 watts at 120 volts, 60 cycle ac.—**Allied Radio Corp.**, 100 N. Western Ave., Chicago.

MINIATURE HI-FI SPEAKER SYSTEM, Kit AS-81U unfinished, Kit AS-81W walnut. Kit AS-81M mahogany. Response ± 6 db 65–14,500 cycles. 6-inch woofer has mass-loaded cone, 10-oz.



Syntox magnet, 3-inch tweeter. Power-handling capacity 6 watts peak. 8-ohm impedance. 10 $\frac{3}{4}$ x 6 $\frac{1}{2}$ x 6 $\frac{3}{8}$ in.—**Heath Co.**, Benton Harbor, Mich.

FM/AM POLICE RECEIVERS, Model HE-51, 30–50 mc, crystal-controlled and tunable. Model HE-52, 145–175 mc, tunable only. 3-stage



i.f., built-in squelch circuit. 4-in. speaker can be cut out with slide switch for headphone operation.—**Lafayette Radio Electronics Corp.**, 111 Jericho Turnpike, Syosset, N. Y.

FM/FM MULTIPLEX TUNER, Model A-12. Receives mono FM and FM multiplex stereo. Built-in FM multiplex converter on circuit board, stereo indicator light, stereo phase control, adjustable afc, bar-type "eye" tuning indicator, edge-

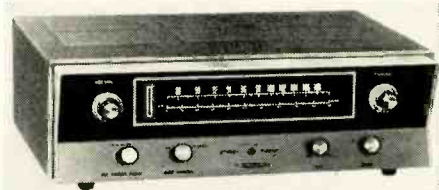

lighted slide-rule tuning dial, flywheel tuning mechanism. Each output filtered to eliminate interacting beatnotes for off-the-air stereo tape recording. Front end of tuner factory assembled and aligned. Unit matches AA-151 stereo ampl.—**Heath Co.**, Benton Harbor, Mich.

TRANSISTORIZED CB RADIO, Model CB-5. For auto installation. 6-channel coverage.



5-watt input, battery drain 1.9 amps. Transistorized superhet receiver, noise limiter, push-to-talk mike, self-contained speaker, agc, squelch circuit. Transmitter uses 3 instant-heating miniature tubes.—**Hallcrafters Co.**, 4401 W. 5th Ave., Chicago 24.

6-CHANNEL MOBILE CB TRANSCEIVER, Drake M-506. 8 x 3 x 9-in. unit can be converted to 23 channels with manufacturer's all-channel

switch. Rear-lighted channel indicator. Transistor dc power supply may be mounted in any location in vehicle. 5-watt plate power input, 3.5-watt power output to antenna. Harmonic suppression 50 db down, frequency stability .005%, receiver



sensitivity 0.4 μ v for 10-db signal-to-noise ratio. Selectivity 5 kc at 6 db, adjacent channel 60 db down, Mike and one crystal included.—**Browning Labs, Inc.**, 100 Union Ave., Laconia, N. H.

5-WATT CB RADIO, Model 515. Transistor, modular construction. Five crystal-controlled channels, miniature crystals available for any of 23 channels. Dual-conversion superhet receiver with tuned ceramic filters, built-in dual power supply 12 vdc/110–220 vac. Audio frequency response 300–3,000 cycles ± 3 db. Built-in speech

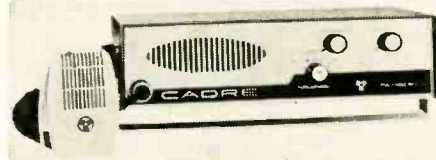

limiting, squelch, agc, noise limiting. Miniature jack for earphones or external speaker. Complete with ac and dc power cords, mounting bracket, dynamic mike. Separate matching rechargeable battery pack adapts unit to lightweight portable transceiver.—**Cadre Industries Corp.**, Commercial Products Div., 20 Valley St., Endicott, N. Y.

CB RADIO, Mark VIII. 27-mc 2-way radio operates on 115-vac power supply. Separate dc power supplies available for 6- or 12-volt mobile operation. Nine crystal-controlled transmit and receive channels; continuously tunable receiver

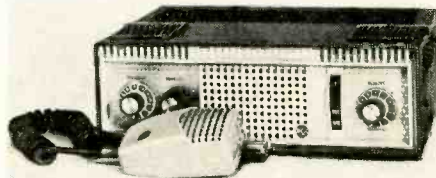

picks up all 23 CB channels; tuning dial shows both channel number and frequency. Max. transmit power 5 watts plate input, 3 watts output. May be mounted on dashboard.—**RCA Electron Tube Div.**, Harrison, N. J.

STEREO FM TUNER, Model 314A Emperor Royale. Front panel controls for afc, interstation squelch, multiplex, noise filter, ac power. Inertia-type flywheel, edge-lighted dial, horizontal tuning indicator for on-frequency tuning and signal strength indication. Mono audio output jack permits all material to be supplied to separate mono amplifier for remote or outdoor locations. FM



sensitivity 1.2 μ v, 20 db quieting. 300-ohm antenna, built-in multiplex. Separation 30 db, 50–15,000 cycles.—**Altec Lansing Corp.**, 1515 S. Manchester Ave., Anaheim, Calif.

EXPANDED-RANGE CB TRANSCEIVER, Range Gain. 23 crystal-controlled transmit and receive channels; 4-way illuminated meter with two scales; illuminated channel selector; antenna-matching adjustment for resistive antenna loads 30–75 ohms; 4 function switch settings for power checks; plate tuning for final amplifier, adjustable squelch. Delta tuning, ± 5 kc channel center frequency, brings in stations slightly off frequency due to crystal tolerance. Speaker terminals for external speaker use with or without internal speaker. Built-in power switch activates universal

RAD-TEL

You Get MORE For Your Money!

RAD-TEL'S QUALITY BRAND NEW TUBES

FOR TV, RADIO AND HI-FI 1-YEAR GUARANTEE

75% OFF

1-DAY SERVICE · Over 500 Types in Stock

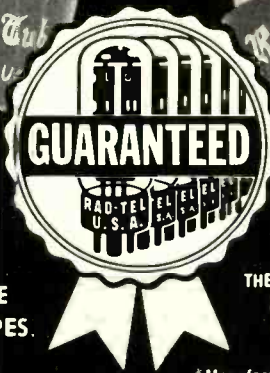

SERVICEMEN: RAD-TEL HAS THE LATEST TUBE TYPES.

THE SIGN OF RAD-TEL'S RELIABILITY FOR OVER 15 YEARS

*Manufacturers Suggested List Price

FREE! Send For New Tube & Parts Catalog
Send For Trouble Shooting Guide



Be your own TELEVISION REPAIRMAN

The Original NOW YOU CAN FIX YOUR OWN TV SET BOOK

You can fix your own TV if you have TV Fixit Book . . . because 80% of troubles are caused by tubes. This book explains, illustrates trouble and what tubes cause this trouble. Pinpoints in over 3000 layouts by model number, position and type tube causing trouble.

\$1.00

No. 170



CHEATER CORD

6 ft., No. 154 29¢ ea. Lots of 3 - 25¢ ea.

Easy to work on set while panel is off.



RAD-TEL TUBE CO. TV, RADIO AND HI-FI

DEPT. RE-4 55 CHAMBERS STREET, NEWARK 5, NEW JERSEY

TERMS: 25% deposit must accompany all orders, balance C.O.D. Orders under \$5: add \$1 handling charge plus postage. Orders over \$5: plus postage. Approx. 8 tubes per 1 lb. Subject to prior sale. No C.O.D.'s outside continental U.S.A.

EACH TUBE ATTRACTIVELY BOXED & BRANDED RAD-TEL

Qty.	Type	Price	Qty.	Type	Price	Qty.	Type	Price	Qty.	Type	Price
—	0Z4	.79	—	6AU8	.87	—	6K6	.63	—	12CU5	.58
—	1AX2	.62	—	6AV6	.41	—	6S4	.52	—	12CU6	1.06
—	1B3	.79	—	6AW8	.90	—	6SA7GT	.99	—	12CX6	.54
—	1DN5	.55	—	6AX4	.66	—	6SH7	1.02	—	12D4	.69
—	1G3	.79	—	6AX5	.74	—	6SJ7	.88	—	12DE8	.83
—	1J3	.79	—	6BA6	.50	—	6SK7GT	.95	—	12DL8	.88
—	1K3	.79	—	6BC5	.61	—	6SL7GT	.84	—	12DQ6	1.04
—	1R5	.77	—	6BC8	1.04	—	6SN7	.65	—	12DS7	.84
—	1S5	.75	—	6BE6	.55	—	6SQ7GT	.94	—	12DT5	.76
—	1T4	.72	—	6BF5	.90	—	6T4	.99	—	12DT7	.79
—	1U5	.65	—	6BF6	.44	—	6T8	.85	—	12DT8	.78
—	1X2B	.82	—	6BG6	1.70	—	6U8	.83	—	12DW8	.89
—	2AF4	.96	—	6BH8	.98	—	6V6GT	.54	—	12DZ6	.62
—	3AL5	.46	—	6BJ6	.65	—	6W4	.61	—	12ED5	.62
—	3AU6	.54	—	6BJ7	.79	—	6W6	.71	—	12EG6	.62
—	3AV6	.42	—	6BK7	.85	—	6X4	.41	—	12EK6	.62
—	3BC5	.63	—	6BL7	1.09	—	6X8	.80	—	12EL6	.50
—	3BN6	.75	—	6BN6	.74	—	7A8	.68	—	12EZ6	.57
—	3BU8	.78	—	6BQ6	1.12	—	7AU7	.65	—	12F8	.66
—	3BY6	.58	—	6BQ7	1.00	—	7EY6	.75	—	12FA6	.79
—	3BZ6	.56	—	6BU8	.70	—	7Y4	.69	—	12FM6	.50
—	3CB6	.56	—	6BX7	1.11	—	8AU8	.90	—	12FR8	.97
—	3CS6	.58	—	6BZ6	.55	—	8AW8	.93	—	12FX8	.90
—	3DG4	.85	—	6BZ7	1.03	—	8BQ5	.60	—	12GC6	1.06
—	3DK6	.60	—	6C4	.45	—	8CG7	.63	—	12J8	.84
—	3DT6	.54	—	6CB6	.55	—	8CM7	.70	—	12K5	.75
—	3GK5	.99	—	6CD6	1.51	—	8CN7	.97	—	12L6	.73
—	3Q4	.63	—	6CG7	.61	—	8CS7	.74	—	12SF7	.69
—	3S4	.75	—	6CG8	.80	—	8EB8	.94	—	12SK7GT	.95
—	3V4	.63	—	6CL8	.79	—	8FQ7	.56	—	12SL7	.80
—	4BQ7	1.01	—	6CM7	.69	—	9CL8	.79	—	12SN7	.67
—	4CS6	.61	—	6CN7	.70	—	11CY7	.75	—	12SQ7GT	.91
—	4DT6	.55	—	6CQ8	.92	—	12A4	.60	—	12U7	.62
—	4GM6	.60	—	6CR6	.60	—	12AB5	.60	—	12V6	.63
—	5AM8	.79	—	6CS6	.57	—	12AC6	.55	—	12W6	.71
—	5AN8	.90	—	6CS7	.69	—	12AD6	.57	—	12X4	.47

RAD-TEL TUBE CO. NOT AFFILIATED WITH ANY OTHER MAIL ORDER TUBE COMPANY

—	5AQ5	.54	—	6CU5	.58	—	12AE6	.50	—	17AX4	.67
—	5AT8	.83	—	6CU6	1.08	—	12AE7	.94	—	17DQ6	1.06
—	5BK7	.86	—	6CY5	.70	—	12AF3	.73	—	18FW6	.49
—	5BQ7	1.01	—	6CY7	.71	—	12AF6	.67	—	18FX6	.53
—	5BR8	.83	—	6DA4	.68	—	12AJ6	.62	—	18FY6	.50
—	5CG8	.81	—	6DE6	.61	—	12AL5	.47	—	19AU4	.87
—	5CL8	.76	—	6DG6	.62	—	12AL8	.95	—	19BG6	1.39
—	5CQ8	.84	—	6DJ8	1.21	—	12AQ5	.60	—	19EA8	.79
—	5EA8	.80	—	6DK6	.59	—	12AT6	.50	—	19T8	.85
—	5EU8	.80	—	6DN6	1.55	—	12AT7	.76	—	21EX6	1.49
—	5J6	.72	—	6DQ6	1.10	—	12AU6	.51	—	25AX4	.70
—	5T8	.86	—	6DT5	.81	—	12AU7	.61	—	25C5	.53
—	5U4	.60	—	6DT6	.53	—	12AV6	.41	—	25CA5	.59
—	5U8	.84	—	6DT8	.94	—	12AV7	.82	—	25CD6	1.52
—	5V6	.56	—	6EA8	.79	—	12AX4	.67	—	25CU6	1.11
—	5X8	.82	—	6EB5	.73	—	12AX7	.63	—	25DN6	1.42
—	5Y3	.46	—	6EB8	.94	—	12AY7	1.44	—	25EH5	.55
—	6AB4	.46	—	6EM5	.77	—	12AZ7	.86	—	25L6	.57
—	6AC7	.96	—	6EM7	.82	—	12B4	.68	—	25W4	.68
—	6AF4	1.01	—	6EU8	.79	—	12B06	.50	—	32ET5	.55
—	6AG5	.70	—	6EV5	.75	—	12BE6	.53	—	35C5	.51
—	6AH4	.81	—	6EW6	.57	—	12BF6	.60	—	35L6	.60
—	6AH6	1.10	—	6EY6	.75	—	12BH7	.77	—	35W4	.42
—	6AK5	.95	—	6FG7	.69	—	12BK5	1.00	—	35Z5	.60
—	6AL5	.47	—	6FV8	.79	—	12BL6	.56	—	36AM3	.36
—	6AM8	.78	—	6GH8	.80	—	12BQ6	1.16	—	50B5	.69
—	6AQ5	.53	—	6GK5	.61	—	12BR7	.74	—	50C5	.53
—	6A55	.60	—	6GK6	.79	—	12BV7	.76	—	50EH5	.55
—	6AT6	.49	—	6GN8	.94	—	12BY7	.77	—	50L6	.61
—	6AT8	.86	—	6H6	.58	—	12BZ7	.86	—	70L7	.97
—	6AU4	.85	—	6J5GT	.51	—	12CN5	.56	—	117Z3	.85
—	6AU6	.52	—	6J6	.71	—	12CR6	.67	—	807	.75

ORDER FORM MAIL TODAY

RAD-TEL Tube Co.
Dept. RE-4
55 Chambers Street
Newark 5, New Jersey

Total Tubes \$ _____
Total Part(s) \$ _____
Postage \$ _____
Grand Total \$ _____

ENCLOSED IS \$ _____ Please rush order.

SEND: _____ Book(s) Be Your Own TV Repairman @ \$1.00 ea. #170
_____ Cheater Cord 29c ea. Lots of 3 - 25c ea. #154
Orders under \$5.00 - Add \$1.00 handling charge - plus postage.

FREE! Send FREE Tube and Parts Catalog
 Send FREE Trouble Shooting Guide

NAME _____
ADDRESS _____
CITY _____ ZONE _____ STATE _____

New... DeVry Technical Institute's



TRANSISTORIZED METER

- PORTABLE
 - LOW-PRICED **\$89.50**
 - Factory Wired
- Unwired Kit... \$64.50 F.O.B. Chicago

This latest achievement of DeVry Technical Institute's Product Research Division gives the engineer and technician a freedom in making measurements that he's probably never before known! Take it anywhere — it operates on flashlight batteries, weighs only 4½ pounds, is compact and self-contained. And it does the job of both vacuum tube voltmeter and a sensitive microammeter. What's more, special circuits provide full protection for the meter movement. No burn-out worries, no line cord, no vacuum tubes. Check these advantages: High input impedance, excellent temperature stability, silicon semiconductors, 1% attenuator resistors, concentric controls, calibration to 1 microampere, separate calibration for each function. Then check that price! This DeVry Transistorized Meter is the first of its type — at anywhere near that price! Order direct (not sold through distributors). Satisfaction guaranteed.

SPECIFICATIONS

- DC Current 0-50/0-500 μ a, 0-5/0-50 ma.
- DC Voltage 0-1/0-10/0-100/0-1000
- AC Voltage 0-5/0-50/0-500/0-1000
- Resistance 0-10 Megohms in 4 ranges
- Power 3-D cells and 1-C cell
- AC Frequency Response ± 1.5 db from 10 cps to 500 kcs
- AC Input Impedance as high as 1.85 Megohms
- DC Input Impedance approximately 10 Megohms on most ranges

Product Research Division

DeVry
TECHNICAL
INSTITUTE

4141 Belmont Ave.,
Chicago 41, Illinois Dept. RD-3

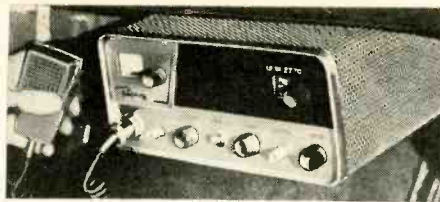

power supply. Separate volume control, adjustable automatic noise limiter. Mike input with screw-type connector permits positive connection of ceramic mike with coiled cord.—**Regency Electronics, Inc.**, Range Gain Dept., 7900 Pendleton Pike, Indianapolis 26, Ind.

SHORT-WAVE RECEIVERS, Models WR-1500 & WR-1000. Each has three sw bands plus extended-range broadcast band. Slide rule dial, headset jack for private listening, beat frequency oscillator. **WR-1000** (illustrated) has sw bands

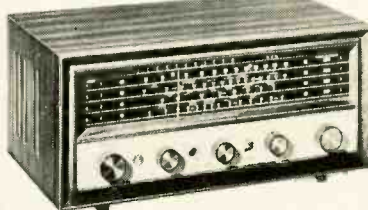

1.6-30 mc. **WR-1500** has sw bands 1.6-31 mc, covers long-wave navigation and weather band. Special jack connects with hi fi system; unit acts as tuner of radio broadcasts or amplifier/speaker for record player.—**Hallcrafters Co.**, 4401 W. 5th Ave., Chicago 24, Ill.

STEREO MULTIPLEX FM/AM TUNER KIT, Model KG-50. Pre-wired FM front end, pre-tuned i.f. coils, point-to-point wiring. FM tuning eye, edge-lit dial, rear-panel channel separation

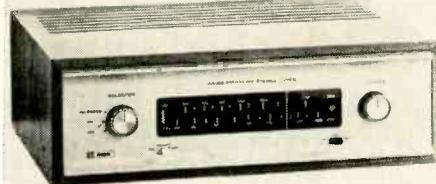

control. Rf stage, 2 i.f.'s, afc. AM circuit has 10-kc i.f. bandwidth. IHFM sensitivity 3 μ v, 30 db quieting. Response ± 1 db, 50-15,000 cycles. I.f. and detector bandwidth 200 kc, hum and noise 40 db below 1 volt. Channel separation 30 db, FM antenna 300-ohm twin-line. AM specifications: Sensitivity 3 μ v, 10 db signal-to-noise ratio; hum and noise 40 db below 1 volt; AM antenna ferrite loopstick.—**Allied Radio Corp.**, 100 N. Western Ave., Chicago 80, Ill.

ELECTRONIC FILTER, "Q" Multiplier, Kit Model HD-11. Built-in power supply, power light indicator. For use with any communications type receiver with i.f. frequency 450-460 kc. Produces



sharply-peaked i.f. curve for CW reception, broad peaked i.f. for phone operation or deep rejection notch to eliminate closely interfering heterodyne. Peak and notch positions tunable to any point in receiver's i.f. bandpass. Complete with connecting i.f. cable, plug and socket.—**Heath Co.**, Benton Harbor, Mich.

BROAD-BAND VHF ANTENNA, Model

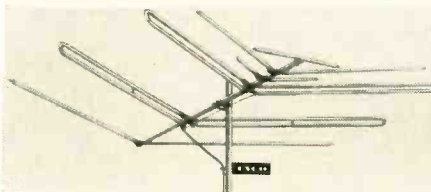

C-33, Color Guard. Average gain 10.5 db on high-band channels, 8.5 db on low-band. Uniformly flat response. Folded dipole construction, heavy phasing brace. Made of chrome aluminum alloy, gold conductive coating.—**TACO, Technical Appliance Corp.**, Sherburne, N. Y.

HIGH-MODULATION FM SIG GEN, Model 1066 B/M1. Accepts modulating frequencies from dc to 100 kc, produces deviations to ± 100 kc.



Carrier frequency variable 10 mc-470 mc in 5 bands. Direct carrier-frequency generation without amplifiers, frequency stability 0.0025% over 10-minute period. FM on CW less than 100 cycles. FM deviation variable to 100 kc, using built-in 1- and 5-kc oscillators or external modulating signals.—**Marconi Instrument Corp.**, 111 Cedar Lane, Englewood, N. J.

CAPACITOR CHECKER, Model TE-44. Tuning eye indicator, checks capacitors 10 pf-2,000 μ f for open or shorted conditions without unsoldering. Uses 20-24 mc frequency for open test,

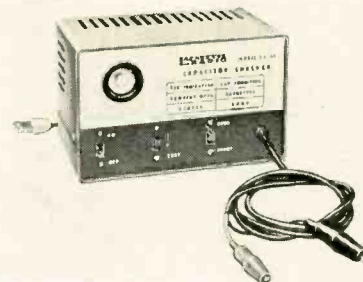

60-cycle for short test. Built-in power supply uses selenium rectifier. For 105-120 volts, 60 cycles ac. Complete with test leads.—**Lafayette Radio Electronics Corp.**, 111 Jericho Turnpike, Syosset, N. Y.

IN-LINE ANTENNA TESTER, Model 520A (illustrated). Reads antenna efficiency plus rf power output. Top scale reads in swr 1:1-8:1, antenna efficiency in percent and in good-poor.

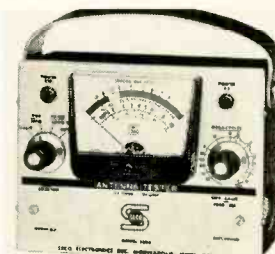

Bottom scale, calibrated in 3 ranges, reads directly in watts—0-10, 0-100, 0-1,000. For 50-ohm coax lines. Dual air coupler rated at 1,000 watts max. Kit of accessory adapters (**Model 520AP**) has 24-inch coax cable with phone tips to coax adapter.—**Seco Electronics, Inc.**, Dept. 164, 1201 S. Clover Dr., Minneapolis 20, Minn.

SWEEPING OSCILLATOR, Sona-sweep 1141-A. Beat-frequency device for measurement and alignment of ultrasonic amplifiers in sonar



and communication systems. Frequency range 20 cycles-200 kc, available at 5-cycle sweep rate.

NEW!

INTERNATIONAL EXECUTIVE TRANSCEIVER Model 1500



Designed for the Hobbyist . . . Complies with FCC Part 15 (no license) requirements

Here is International's new Model 1500 Executive transceiver for radio communication within the 27 mc frequency range. Designed and engineered for phone and cw (code), you can talk from 1 to 10 miles with other Part 15 stations depending on the height of the antenna. You are also permitted to work skip signals 1,000 miles or more with other Part 15 stations when a band opening occurs. And . . . no FCC license is required.

This feature packed transceiver puts the maximum RF power into the antenna by combining the transmitter and antenna for rooftop mounting. A second unit houses a supersensitive receiver and exciter, while a preamplifier at the antenna boosts weak signals for better reception. Other features include a special crystal filter for reducing interference from adjacent channel Class D two-way radios.

- 100 milliwatts input / 60" antenna
- 115 vac operation
- Phone and CW
- Eight channels . . . crystal controlled
- 27 mc frequency range

A complete, "ready to go", package. 1 receiver/exciter complete with 8 sets of crystals, 2 transmitter/antenna assembly, 3 antenna mount, 4 5 foot mast, 5 100 feet of control cable, 6 microphone, 7 key for (CW)

Model 1500 transceiver complete.....\$299.50*

See the Model 1500 transceiver at your International dealer.

* other models from \$80.00

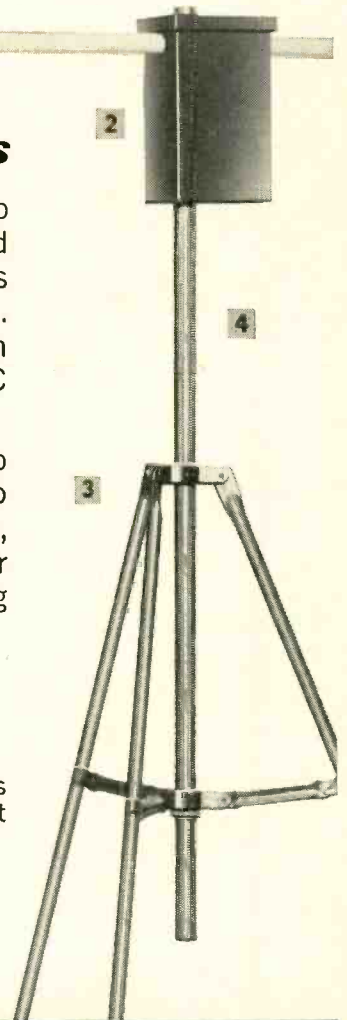

Write today for International's 1963 catalog.

ATR

PRODUCTS FOR MODERN LIVING



A.C. HOUSEHOLD ELECTRICITY
 Anywhere... in your own car, boat or plane
 Operates Standard A.C.
 • Record Players
 • Dictating Machines
 • Small Radios
 • Electric Shavers
 • Heating Pads, etc.
 In your own car or boat!

ATR PLUG-IN TYPE PORTABLE INVERTERS*

MODELS
 6-RMF (6 volts) 60 to 80 watts. Shipping weight 12 lbs. DEALER NET PRICE... \$33.00
 12T-RME (12 volts) 90 to 125 watts. Shipping weight 12 lbs. DEALER NET PRICE... \$33.00
 *Additional Models Available

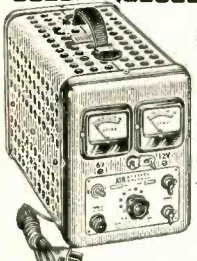

ATR "A" BATTERY ELIMINATOR

For Demonstrating and Testing Auto Radios—**TRANSISTOR or VIBRATOR OPERATED!**

Designed for testing D.C. Electrical Apparatus on Regular A.C. Lines—Equipped with Full-Wave Dry Disc-Type Rectifier, assuring noiseless, interference-free operation and extreme long life and reliability.

MAY ALSO BE USED AS A BATTERY CHARGER
 MODEL 610C-ELIF... 6 volts at 10 amps. or 12 volts at 6 amps. Shipping weight 22 lbs.
 DEALER NET PRICE... \$49.95
 MODEL 620C-ELIT... 6 volts at 20 amps. or 12 volts at 10 amps. Shipping weight 33 lbs.
 DEALER NET PRICE... \$66.95

AUTO-RADIO VIBRATORS



By every test ATR Auto-Radio Vibrators are best!... and feature Ceramic Stack Spacers, Instant Starting, Large Oversized Tungsten Contacts, Perforated Reed, plus Highest Precision Construction and Workmanship and Quiet Operation!



There is an ATR VIBRATOR for every make of car!
 Ask your distributor for ATR's Low Priced type 1400, 6 volt 4-prong Vibrator; and 1843, 12 volt 3-prong; or 1840, 12 volt 4-prong Vibrator. THE WORLD'S FINEST!

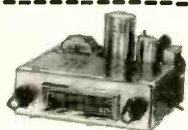

ATR UNIVERSAL KARADIO

MODEL 600 SERIES
 Easily installed in-dash or under-dash. Amplifier power-supply chassis may be separated from tuner chassis for installation flexibility and easy servicing. Utilizes 6-tube super heterodyne circuit (2 dual-purpose tubes) with 8-tube performance... pulls in those distant stations with good tone and volume. Supplied with separate 5" x 7" speaker which is installed in original automobile speaker compartment for high fidelity performance. Neutral gray-tan baked enamel finish. Over-all size 4" deep x 6 1/2" wide x 2" high. Tuner Chassis; with Amplifier Chassis, 2 3/8" deep x 6 1/2" wide x 3 7/8" high. Shipping weight 7 lbs. WILL OUTPERFORM MOST SETS!
 Model 612—12 volt Dealer Net Price... \$31.96
 Model 606—6 volt Dealer Net Price... \$31.96

ATR TRUCK KARADIO

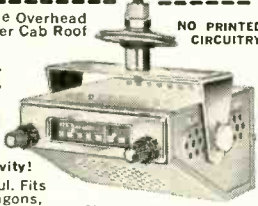

Excellent Tone, Volume, and Sensitivity!
 Compact, yet powerful. Fits all trucks, station wagons, most cars and boats. Just drill a 1/8 inch hole in roof and suspend the one-piece unit (aerial, chassis and speaker) in minutes. Watertight mounting assembly holds antenna upright. Yoke-type bracket lets you tilt radio to any angle.
 Extra-sensitive radio has 6 tubes (2 double-purpose), over-size Alnico 5 PM speaker for full, rich tone. Big, easy-to-read illuminated dial. Fingertip tuning control. Volume and tone controls. 33-in. stainless steel antenna. Neutral gray-tan enameled metal cabinet, 7 x 6 1/2 x 4 in. high over-all. Shipping weight 10 1/2 lbs.
 Model TR-1279—12A for 12V Dealer Net Price \$41.96
 Model TR-1279—6A for 6V Dealer Net Price \$41.96

SEE YOUR ELECTRONIC PARTS DISTRIBUTOR
 WRITE FACTORY FOR FREE LITERATURE...
ATR ELECTRONICS, INC.
 Formerly: American Television & Radio Co.
 Quality Products Since 1931
 ST. PAUL 1, MINNESOTA—U.S.A.

Sweep width 0-2 kc, 100 cycles-20 kc; sweep rates 30 cycles locking in line, 5-25 cycles manually variable. Crystal-positioned, pulse-type standard markers at 50, 100, 200 kc, usable singly or collectively, may be varied with specs. CW oscillator may be used to generate variable pulse marker. Attenuation switched 20, 20, 10, 6, 3 db plus 6 db variable. Rf output 0.25 volts rms into 70 ohms flat to ±0.5 db. Power supply input approximately 160 watts, 117 volts, 50/60 cycles ac B+, electronically regulated. Sweep output has regular sawtooth synchronized with sweeping oscillator, approximate amplitude 7 volts. Marker amplitude positive pulse, continuously variable 0-10 volt peak. Separate marker output.—**Kay Electric Co.**, Dept. R E, Maple Ave., Pine Brook, Morris County, N. J.

TUNING FORK OSCILLATOR, Model T/-60. Subminiature, 60-cycle oscillator has accuracy ±.00001%, stability ±.0025%, over temperature range -56°C+100°C. Accuracy maintained without use of oven heat. Hermetically sealed in a

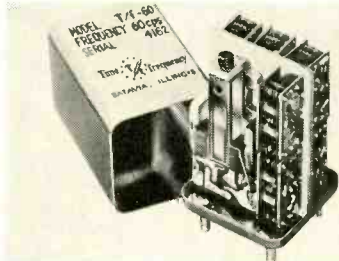

1-19/32-in. square, 2 3/8-in. high steel case. Output signal 60 cycles, square wave output 14v p-p from specified input 12-60 vdc. Current drain less than 60 ma. In military and commercial models.—**Time & Frequency**, 127 S. Batavia Ave., Batavia, Ill.

PORTABLE ELECTRONIC TACHOMETER, Model 24. Transistor unit measures speed of any revolving or reciprocating device (0-2,400 rpm) without electrical or mechanical contact. Accurate to ±2% of full scale reading of 2,400 rpm. Self-contained, portable. Built-in battery power sup-

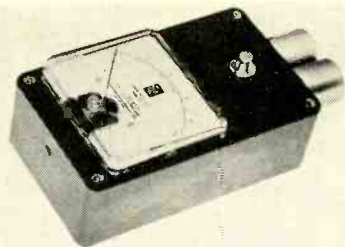

ply.—**Pioneer Electric & Research Corp.**, 743 Circle Ave., Forest Park, Ill.

CRT CHECKER/REJUVENATOR, Model CR125. Dc used on all checks to correlate with tube manual data. Makes inter-element shorts test, cathode emission, dynamic control grid check, life test, cathode and control grid rejuvenation, shorts removal, cathode welding. Tube rejuvenation and short removal done with special R-C timing network. All tests performed without spe-



cial adaptors by use of cable with all six crt sockets. Color guns checked and rejuvenated individually.—**Sencore, Inc.**, 426 S. Westgate Dr., Addison, Ill.

ILLUMINATED PUSH-BUTTON SWITCHES, NF-Lite. Flat-frame, leaf-type momentary action switches for control panels and press-to-test applications. Wide range multiple pole switching from single spst normally open to 3pdt.

I E E E

MEET

THE BEST BRAINS,
 THE BEST PRODUCTS
 IN THE INDUSTRY

at

I-TRIPLE-E's

International Convention
 and Exhibition in New York

MARCH 25, 26, 27, 28

The COLISEUM at Columbus Circle
 & The WALDORF ASTORIA HOTEL

admission: MEMBERS \$1.00; NON-MEMBERS \$3.00
 MINIMUM AGE: 18

SHOW

(formerly the IRE Show)

TELL YOUR FRIENDS ABOUT Radio-Electronics

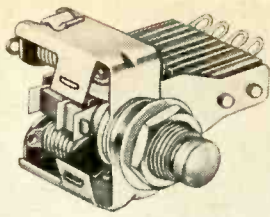

Contacts fine silver, rated at 3 amps, 120 volts, ac, non-inductive load. Lamp voltages 6 and 28; Lamps in snap-out assembly. *Series 4100* single lamp, *Series 4200* (illustrated) dual-lamp switch. Both mount in single 3/8-in. diameter hole.—Switchcraft, Inc., 5555 N. Elston Ave., Chicago 30, Ill.

EPOXY CONDUCTIVE CEMENT, K20. Two-part filled epoxy system. Initial volume resistivity 0.02 ohm-cm holds constant to over 100°C. When cement is aged at 150°C, initial



resistivity drops to 0.0007 ohm-cm, rises to 0.0009 ohm-cm at 150°C. Mixing ratio one-to-one by volume. Available in self-metering tube kit (illustrated) or in bulk. Cures in 24 hours at room temperature, optimum properties obtained when cured 2 hours at 60°C.—Hysol Corp., Olean, N.Y.

LOUDSPEAKER PLUGS, SOCKETS, Series



Specifications from manufacturer's data.

8-8145. Available with off contact at 180° changeability; without off contact; without changeable contact, to be used in place of closed-circuit phone jack. 9/16 x 9/16-in. plug has snap-action assembled plastic housed 2-pin configuration with metal strain relief. Sockets of molded phenolic. Metal mounting brackets in 9 configurations provide screw holes and/or rivet flanges.—Telephone Dynamics Corp., 32 Sunrise Highway, Baldwin, N. Y.

ANTI-STATIC RECORD CLEANER. *Foam Coar.* Round polyurethane sponge, treated with manufacturer's Lubri-Stat, cleans record surfaces.



Twelve packs mounted on easel-type display board for wall hanging or counter display.—Fidelitone, Inc., 6415 Ravenswood Ave., Chicago 26, Ill.

CRIMPING TOOL, Part No. 3525. Heavy, nickel-plated steel. Handles pull apart to open jaws to full distension. Once crimping starts, jaws



will not release until closed completely. **Cambridge Thermionic Corp.**, 445 Concord Ave., Cambridge 38, Mass.

a 3 SPEAKER SYSTEM 24.65
only 3 1/2" slim... for only 24 ea.

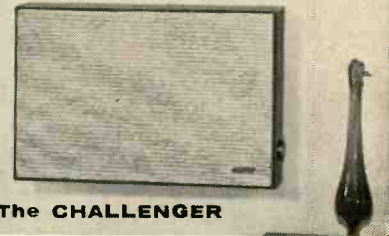

The CHALLENGER

Hangs on the wall like a picture... and fills the room with realistic sound

The CHALLENGER is super-slim in size—full-bodied in sound. Three advanced speakers are employed—two high efficiency 6"x9" speakers and a 4" tweeter—to deliver astounding sound reproduction for a unit of this size and low cost. Handsome solid walnut cabinet and smart two-tone grille cloth.

Perfect for FM Multiplex, economy hi-fi or stereo, extension speaker for record player, radio or TV. Can be used on a shelf, table, floor or wall mounted. Special mounting clips are included for flush wall mounting.

The Challenger 3 Speaker System... electrical crossover—20 watts peak power—volume control. 18" wide x 12" high x 3 1/2" slim.

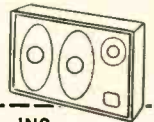

CENTURY ELECTRONICS CO., INC.
352 Maple Avenue, Westbury, N.Y. RE-4

Please ship _____ Challengers at \$24.65 each. My remittance for \$ _____ is enclosed. It is understood that I have a 10 day return privilege for full refund if not completely satisfied.

Name _____
Address _____
City _____ Zone _____ State _____
Century Electronics pays the freight

TV-RADIO Servicemen or Beginners..

2 WEEKS FREE TRIAL!

Just Send name for **Coyne's** Seven Volume Job-Training Library!



The Best Practical TV-RADIO-ELECTRONICS Shop Library!

Answers ALL Servicing Problems QUICKLY... Makes You Worth More On The Job!

Put money-making, time-saving TV-RADIO-ELECTRONICS know-how at your fingertips—examine Coyne's all-new 7-Volume TV-RADIO-ELECTRONICS Reference Set for TWO WEEKS at our expense! Shows you the way to easier TV-Radio repair—time saving, practical working knowledge that helps you get the BIG money! How to install, service and align ALL radio and TV sets, even color-TV, UHF, FM and transistorized equipment. New photo-instruction shows you what makes equipment "tick." No complicated math or theory—just practical facts you can put to use immediately. Over 3,000 pages; 1200 diagrams; 10,000 facts! Ready to use in shop or home.

SEND NO MONEY! Just mail coupon for 7-Volume TV-Radio Set on TWO WEEKS FREE TRIAL! We'll include the FREE BOOK below. If you keep the set, pay only \$3 after TWO WEEKS and \$3 per month until \$27.25 plus postage is paid. Cash price only \$24.95. Or return set at our expense in TWO WEEKS and owe nothing. Offer limited, so act NOW!

"LEARNED MORE FROM THEM THAN FROM 5 YEARS WORK!"

"Learned more from your first two volumes than from 5 years work."
—Guy Bliss, New York

"Swell set for either the serviceman or the beginner. Every service bench should have one."
—Melvin Masbruch, Iowa.

KEEP FREE DIAGRAM BOOK EVEN IF YOU RETURN THE SET

We'll send you this big book, "150 Radio-Television Picture Patterns and Diagrams Explained" ABSOLUTELY FREE just for examining 7-Volume Shop Library on TWO WEEKS FREE TRIAL! Shows how to cut servicing time by reading picture-patterns, plus schematic diagrams for many TV and radio sets. Yours to keep FREE even if you return the 7-Volume Set! Mail coupon TODAY!



Like Having An Electronics Expert Right At Your Side!

ALL 7 BOOKS HAVE WASHABLE, VINYL CLOTH COVERS

VOL. 1—EVERYTHING ON TV-RADIO PRINCIPLES! 300 pages of practical explanations; hundreds of illustrations.

VOL. 2—EVERYTHING ON TV-RADIO-FM RECEIVERS; 403 pages; fully illustrated.

VOL. 3—EVERYTHING ON TV-RADIO CIRCUITS! 336 pages; hundreds of pictures and circuits.

VOL. 4—EVERYTHING ON SERVICING INSTRUMENTS! How they work, how to use them. 368 pages; illustrated.

VOL. 5—EVERYTHING ON TV TROUBLESHOOTING! Covers all types of sets, 437 pages; illustrations, diagrams.

VOL. 6—TV CYCLOPEDIA! Quick and concise answers to TV problems in alphabetical order, including UHF, Color TV and Transistors; 868 pages.

VOL. 7—TRANSISTOR CIRCUIT HANDBOOK! Practical Reference Transistor Applications; over 200 Circuit Diagrams; 472 pages.

FREE BOOK—FREE TRIAL COUPON!

COYNE SCHOOL PUBLICATIONS, Dept. 43-RE
1455 W. Congress Parkway, Chicago 7, Illinois

Yes! Send me COYNE'S 7-Volume Applied Practical TV-RADIO-ELECTRONICS Set for TWO WEEKS FREE TRIAL. Include "Patterns & Diagrams" book FREE!

Name _____ Age _____

Address _____

City _____ Zone _____ State _____

Check here if you are sending \$24.95 in full payment. Same TWO WEEK Money-Back Guarantee applies.

Coyne

SCHOOL PUBLICATIONS
Dept. 43-RE, 1455 W. Congress Parkway, Chicago 7, Ill.

"SUCH STUFF AS DREAMS ARE MADE OF"

with apologies to Shakespeare — however, the **VALUES** we offer, can make a **BUYER'S** fondest dreams come true!

Our **TREMENDOUS BUYING POWER & PURCHASING EXPERIENCE** make it possible. We invest Thousands of Dollars (in just a single item) to create a good **DOLLAR BUY**, resulting in the **AMAZING & EXCITING OFFERS** that follow:

10% OFF & FREE GIFT — ON PURCHASE OF \$10 OR OVER (ON DOLLAR BUYS)

- \$15.00 RADIO PARTS "JACKPOT" handy assortment \$1
- 20—ASST. ROTARY SWITCHES All popular types over \$20 value \$1
- 1—LB SPOOL ROSIN-CORE SOLDER 40/60 \$1
- WEBSTER STEREO CARTRIDGE #80-2, standard for all pickups \$1
- 6—TV ALIGNMENT TOOLS \$1
- 6—TRANS. RADIO BATTERIES 9 volt, same as Eveready #216 \$1
- 1—EMERGENCY AUTO LAMP Red dome blinker, incl Battery \$1
- 1—6" x 9" OVAL PM SPEAKER (one to a customer) \$1
- 1—5" PM SPEAKER Alnico #5 magnet \$1
- 1—4" PM SPEAKER Alnico #5 magnet \$1
- 10—SPEAKER PLUG SETS Deluxe 2 cond wired value \$5.00 \$1
- 3—AUDIO OUTPUT TRANSFORMERS 50L6 type \$1
- 3—AUDIO OUTPUT TRANSFORMERS 6K6 or 6V6 type \$1
- 3—I.F. COIL TRANSFORMERS 456kc, most popular type \$1
- 15—RADIO OSCILLATOR COILS standard 456kc \$1
- 3—I.F. COIL TRANSFORMERS 10.7mc for FM \$1
- 2—G.E. #RTL-143 I.F. COIL TRANSFORMERS 456kc w/flange \$1
- 3—I.F. COIL TRANSFORMERS 262kc for Auto Radios \$1
- 4—OVAL LOOP ANTENNAS assorted popular sizes \$1
- 3—LOOPSTICK ANTENNAS hi-gain, ferrite, adjustable \$1
- 3—1/2 MEG VOLUME CONTROLS with switch, 3" shaft \$1
- 5—ASST. 4 WATT WIREWOUND CONTROLS \$1
- 10 — ASSORTED VOLUME CONTROLS less switch \$1
- 5—ASSORTED VOLUME CONTROLS with switch \$1
- 5—50K VOLUME CONTROLS less switch \$1
- 5—1/2 MEG VOLUME CONTROLS less switch \$1
- 10—SURE-GRIP ALLIGATOR CLIPS 2" plated \$1
- 10—SETS PHONO PLUGS & PIN JACKS RCA type \$1
- 20—ASST. PILOT LIGHTS #44, 46, 47, 51, etc. \$1
- 50—ASSORTED TERMINAL STRIPS 1, 2, 3, 4 lugs \$1
- 100'—FINEST NYLON DIAL CORD best size, .028 gauge \$1
- 50—ASST. RADIO KNOBS screw and push-on types \$1
- 25—ASST. CLOCK RADIO KNOBS in colors \$1
- 25—ASSORTED PRINTED CIRCUIT SOCKETS best types \$1

- 100—ASSORTED 1/2 WATT RESISTORS some in 5% \$1
- 70 — ASSORTED 1 WATT RESISTORS some in 5% \$1
- 35 — ASSORTED 2 WATT RESISTORS some in 5% \$1
- 20—ASST. DIODE CRYSTALS fine assortment. Latest types \$1
- 2—SYLVANIA EPOXY SILICON RECTIFIERS 750ma-400 piv \$1
- 20 — ASS'TED WIREWOUND RESISTORS 5, 10, 20 watt \$1
- 10 — ASST. RADIO ELECTROLYTIC CONDENSERS \$1
- 5—ASST. TV ELECTROLYTIC CONDENSERS \$1
- 50—ASST MOLDED CONDENSERS short leads \$1
- 20—GOODALL TUBULAR CONDENSERS .047-600v \$1
- 30—MICAMOLD ASST TUBULAR COND. molded seatite \$1
- 300—ASST. 1/2 W RESISTORS Top Brand, Short leads, excellent \$1
- 10—6' ELECTRIC LINE CORDS with plug \$1
- 4—50' SPOOLS HOOK-UP WIRE 4 different colors \$1
- 50—STRIPS ASSORTED SPAGHETTI handy sizes \$1
- 100 — ASSORTED RUBBER GROMMETS best sizes \$1
- 200'—BUSS WIRE #20 tinned for hookups, special circuits, etc. \$1
- 250—ASST. SOLDERING LUGS best types and sizes \$1
- 250—ASST. SELF TAPPING SCREWS #6, #8, etc. \$1
- 150—ASST. 6/32 SCREWS and 150 6/32 HEX NUTS \$1
- 150—ASST. 8/32 SCREWS and 150—8/32 HEX NUTS \$1
- 150—6/32 HEX NUTS and 150—8/32 HEX NUTS \$1
- 8—ASST. LUCITE CASES hinged cover, handy for parts \$1
- 4—TOGGLE SWITCHES SPST, SPDT, DPST, DPDT \$1
- 10 — ASSORTED SLIDE SWITCHES SPST, DPDT, etc. \$1
- 100—ASST RUBBER & FELT FEET FOR CABINETS best sizes \$1
- 50—100K 1/2 WATT RESISTORS 10% \$1
- 50—470K 1/2 WATT RESISTORS 10% \$1
- 50—ASST. MICA CONDENSERS some in 5% \$1
- 50—ASST. DISC CERAMIC CONDENSERS popular numbers \$1
- 25—ASSORTED MICA TRIMMER CONDENSERS \$1
- 3—SELENIUM RECTIFIERS 2—65ma and 1—75ma \$1
- 2—SELENIUM RECTIFIERS 1—100 ma and 1—250 ma \$1
- 2—SELENIUM RECTIFIERS 1—65ma and 1—450ma \$1

- \$15.00 TELEVISION PARTS "JACKPOT" best buy ever \$1
- 90° TV DEFLECTION YOKE wired network, schematic diag. \$1
- 90° FLYBACK TRANSFORMER schematic shows many uses \$1
- 70° TV DEFLECTION YOKE wired network, long leads \$1
- 50—ASSORTED TV COILS I.F. video, sound, ratio, etc. \$1
- 1—\$10 INDOOR TV ANTENNA hi-gain, 3 section, tiltproof \$1
- 5—TV CHEATER CORDS with both plugs \$1
- 3—ELECTROLYTIC CONDENSERS 50/30-150v \$1
- 100'—TWIN TV LEAD-IN WIRE 300 ohm, heavy duty \$1
- 50' — FLAT 4-CONDUCTOR WIRE many purposes \$1
- 20—ASSORTED TV KNOBS ESCUTCHEONS etc. \$20 value \$1
- 6—ASSORTED STANDARD TUNER UHF STRIPS \$1
- 10—ASSORTED STANDARD TUNER VHF STRIPS \$1
- 100—ASST. CERAMIC CONDENSERS some in 5% \$1
- 2—TV VERTICAL OUTPUT TRANSFORMERS 18 to 1 ratio \$1
- 2—TV FILTER CHOKE TRANSFORMERS 1—52 ohms, 1—250 ohms \$1
- 20—WIREWOUND RESISTORS 15K—10 watts \$1
- 20—WIREWOUND RESISTORS 40 ohms—10 watts \$1
- 2—RATIO DETECTOR COILS 4.5mc or 10.7mc \$1
- 2—TV SOUND I. F. COILS 4.5mc or 21.25 mc \$1
- 2—SOUND DISCRIMINATOR COILS 4.5mc or 10.7mc \$1
- 50—ASSORTED TV PEAKING COILS all popular types \$1
- 4—ASST. TV ION TRAPS for all type TV Receivers \$1
- 10—TV PICTURE TUBE SOCKETS wired with 20" leads \$1
- 5—TV HI-VOLT ANODE LEADS 20" length \$1
- 10—DIODE CRYSTALS 1N34 \$1
- 10—ASST. DIODE CRYSTALS 5—1N60 and 5—1N64 \$1
- 3—SILICON RECTIFIERS Top Hat 500ma-400 PIV \$1
- 50'—INSULATED SHIELDED WIRE #20 braided metal jacket \$1
- 32'—TEST PROD WIRE deluxe quality, red or black \$1
- 50'—HI-VOLTAGE WIRE for TV, special circuits, etc. \$1
- STANDARD BRAND TUBES 024, 1B3, 1X2, 5U4, 5Y3, 6AC7, 6AU6, 6AX4, 6CB6, 6CG7, 6I6, 6K6, 6SN7, 6UB, 6X8, 12AT7, 12AU7, 12AX4, 50C5, 50L6 Each Tube \$1

MARKET SCOOP COLUMN

- 1—CHAPT. ZU DI MITZIA "JACKPOT" (pleasant surprise) you don't need a gambling stamp \$1
- 100—PRECISION RESISTORS ast. list price \$50.00 less 98% \$1
- 2—IBM COMPUTER SECTIONS loaded with valuable parts \$1
- 1000—ASST. HARDWARE KIT screws, nuts, washers, rivets, etc. \$1
- 1000—SOLID BRASS SCREWS #2/56, 3/8" long, flat head \$1
- 1000—BLACK NICKEL SCREWS #6/40, 1/2" long, flister head \$1
- 100'—STANDARD ZIP CORD 2 conductor #18 white or brown \$1
- 100'—MINIATURE ZIP CORD 2 conductor, serves 101 uses \$1
- 50—G.E. FLASHLIGHT BULBS #PR-9, 2.7, .15A \$1
- 50—PILOT LIGHT SOCKETS bayonet type, wired \$1
- 20 — BALL POINT PENS retractable, assorted colors \$1
- 10—BALL POINT PEN FILLERS black fine-line for drafting and offset, fits 95% of all pens made \$1
- 1—HEARING AID AMPLIFIER incl 3 Tubes, Mike, Etc. (as is) \$1
- 10—PEARL NECKLACES (stimulated) wired for Hearing Aid but serves as regular Necklace 25" long \$1
- 3—3" RECORDER TAPES quality acetate, 150 feet \$1
- 10—3" RECORDER TAPE REELS \$1
- 1—SQ. YARD GRILLE CLOTH most popular brown & gold design \$1
- 500'—CHOICE HOOKUP WIRE ass't colors cut in handy lengths some stripped and tinned \$1
- 100—ASST TUBULAR CONDENSERS. .001 to .47 to 600v \$1
- 100—RADIO & TV SOCKETS \$1 asst 7 pin, 8 pin and 9 pin \$1
- 100—ASSORTED FUSES 3AG and other popular sizes \$1
- 300—CERAMIC CONDENSERS Erie, tubular, 300 mmf—500v \$1
- 10—ASSORTED TUBES Radio, Television and Industrial \$1
- 20—RCA #954 TUBES \$1
- 10—RCA #12L8 TUBES \$1
- 3—STANDARD 35W4 TUBES \$1
- 3—STANDARD 12AT6 TUBES \$1
- 5—RCA #1U4 TUBES also serves as a 1T4 Tube \$1
- COMMODORE 5-TUBE RADIO AC-DC, complete ready to play \$6
- GLOBAL 6-TRANSISTOR RADIO Complete ready to play \$9
- GLOBAL 9-TRANSISTOR RADIO Complete ready to play \$14

HANDY WAY TO ORDER — Simply pencil mark items wanted in squares and enclose with money order or check --- You will receive a new copy of these Offers for re-orders. **ON SMALL ORDERS** — Include stamps for postage, excess refunded - - **LARGER ORDERS** shipped express charges collect **SAME DAY DELIVERY . . . SCIENTIFIC PACKING** for minimum shipping cost.

In order to **SELL**, we must first **BUY** and that we do on a **BIG SCALE**. If you have any **TUBES, CONDENSERS, RESISTORS** or any other **PARTS** in quantity and new that you wish to sell . . . please send us samples . . . We pay **SPOT CASH**.

BROOKS RADIO & TV CORP., 84 Vesey St., Dept. A, New York 7, N. Y. TELEPHONE **CORtland 7-2359**

NEW SEMI CONDUCTORS & TUBES

2N2699

A new type of germanium transistor that combines a micro-alloy emitter junction with a diffused collector junction, and called a micro-alloy diffused electrode (MADE) transistor, was announced by Philco.

It's an avalanche-resistant, 150-mw switching transistor with an emitter breakdown of 4 volts, and a guaranteed open-base collector-to-emitter breakdown rating of 8 volts.

The 2N2699's collector output capacitance is 3.5 pf at 10 volts on the

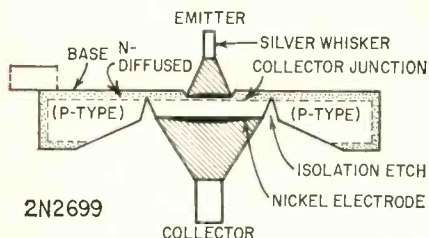

collector, and it offers a tightly specified base input voltage spread of 150 mv at 10 ma collector current and 1 ma base current.

The new structure provides high power dissipation because of a thick mechanical base width, together with high-speed switching because of the narrow electrical basewidth.

2N2381, 2N2382

With a total specified switching time (for 200 ma) of 67 nsec (nanoseconds) maximum, these may well be the fastest transistors of their kind. Designed for line and core-driver applica-



tions, these germanium epitaxial p-n-p units can switch up to half an amp.

The 2381 and 2382 differ in breakdown ratings (and price). Specifications:

	2N2381	2N2382
BV_{CBO}	30	45 volts
BV_{CEO}	15	20 volts
I_C	0.5	0.5 amp
Junction temperature, 100° C		

APRIL, 1963

GUARANTEED!



- Outperforms speakers costing five times more
- Three year warranty against manufacturing defects
- Complete satisfaction or your money back

the **KENT** **\$19.95**
all new...all wood
only

Anglo American Acoustics Ltd. RE 4-63
129 Maryland Ave., Freeport, New York
Gentlemen: Enclosed is my check for \$
Please ship me "Kent" natural wood cabinet speaker(s) at \$19.95 each.
I UNDERSTAND THAT THESE SPEAKER SYSTEMS ARE GUARANTEED AND IF I AM NOT COMPLETELY SATISFIED I MAY RETURN FOR A FULL REFUND WITHIN TEN DAYS AFTER RECEIPT.
NAME
ADDRESS
CITY ZONE STATE

TRANSISTORIZED POWER CONVERTER

12 VOLT DC to 117 VOLT AC

FOR ONLY **\$29.95** DEALER NET

POWERFUL 125 WATT CONTINUOUS DUTY. PROVIDES 117 VOLT 60 CYCLE AC BY PLUGGING INTO CAR OR BOAT 12 VOLT CIGARETTE LIGHTER RECEPTACLE.



MODEL
BX125

MADE
IN U.S.A.

ASK YOUR ELECTRONIC PARTS DISTRIBUTOR FOR

TRANSVERTER

Designed and Manufactured by:

WORKMAN *Electronic*
SARASOTA, FLORIDA PRODUCTS, INC.

For information, write Department MD 383

HOTTEST VALUE EVER OFFERED!



\$200 HEARING AID (as shown)—Your Price . . . \$2

We Scooped the Market on 15000 of these HEARING AIDS from one of the Leading Manufacturers (name withheld) who switched to the Transistor Type.

Each HEARING AID INSTRUMENT is a Complete AUDIO AMPLIFIER and includes—a CRYSTAL MICROPHONE, 3 SUB-MINIATURE TUBES and a Superb Beige Phenolic CABINET.

Indeed a TOP ITEM for the Experimenter—can be modified and converted to: RADIOS—INTERCOMS—TRANSMITTERS—SECRET LISTENING DEVICES — MICROPHONE for Tape Recorders — PRE-AMP & MICROPHONE COMBINATION for Public Address Systems—ETC.

5" x 2 1/2" x 1"—Shipping Weight 1 lb.

Complete as illustrated—including a detailed informative SCHEMATIC DIAGRAM (less Earphone and Battery) **\$2**
EARPHONE, BATTERIES & other ACCESSORIES to Complete Set \$6.98

BROOKS RADIO & TV 84 Vesey St., New York 7, N. Y.



1963
EDITION
NOW
AVAILABLE

PAYS FOR ITSELF ON THE FIRST SERVICE CALL
TUBE CADDY-TUBE SUBSTITUTION GUIDEBOOK

(Direct Receiving Tube Substitutions only—
Direct CRT substitutions)

The Rider Tube Caddy-Tube Substitution Guidebook has become standard equipment in every TV technician's tube caddy. More than a quarter of a million copies have saved time and money for TV technicians. The new '63 edition is completely up-to-date — completely accurate — like its predecessors it contains only direct receiving tube substitutions which can be made without modification of the wiring! The new edition contains substitutions for receiving tubes, ruggedized tubes, European-to-American tubes, American-to-European tubes, and cathode-ray picture tubes. This guidebook will save you time by providing the information you need when you're in a customer's home; eliminate carrying needless tube types; enable you to select the best substitution and minimize sales losses because you don't have the right tube. #299 still only 90 cents.

NEW... SERVICE TOOL
MASTER '45' SPINDLES, MOTORS & TURNTABLES GUIDEBOOK

by Jack Strong
Lists direct replacements for all current 45 rpm spindles. #321, \$2.00

OTHER TIMESAVING RIDER SUBSTITUTION GUIDES
MASTER RECEIVING — PICTURE TUBE SUBSTITUTION GUIDEBOOK

by H. A. Middleton
The answer to all tube substitution problems #244, \$7.45

INTERNATIONAL TRANSISTOR SUBSTITUTION GUIDEBOOK (Direct Substitutions Only)

by Keats A. Pullen, Jr. Eng. D
It provides 4500 direct substitution both electrical and physical. #277, \$1.50

MASTER CARTRIDGE SUBSTITUTION GUIDEBOOK

by Jack Strong
Saves time in locating the right replacement — saves money by cutting down the number of cartridges you need to stock. #288, \$2.00
Get these guides at your distributor, or write

Order today—10-DAY GUARANTEE

JOHN F. RIDER PUBLISHER, INC. DEPT RE-4
A Division of Hayden Publishing Co.
116 W. 14th Street, New York 11, N. Y.

Please send:
 Tube Caddy-Tube Substitution Guidebook (1963), 90c Master '45' Spindles, Motors & Turntable Guidebook, \$2.00 Master Receiving-Picture Tube Substitution Guidebook, \$7.45 International Transistor Substitution Guidebook, \$1.50 Master Cartridge Substitution Guidebook, \$2.00
Payment enclosed — Rider pays postage.
Send C.O.D. plus postage.

NAME _____
ADDRESS _____
CITY _____ ZONE _____ STATE _____

Switching characteristics (both types):

	typical	max
t_s	8 nsec	15 nsec
t_r	20	30
t_f	8	15
t_A	1.6	3.0

The new transistors are made by Motorola.

CP-5 Current-Source Diode

Called a "Currector", this semiconductor is a constant-current diode capable of holding a current to within 2% of its nominal rating up to 25 volts.

It is 0.8 inch in diameter and 1.05 inches long and packaged in an epoxy-filled case. Both the CP-5, polarized,

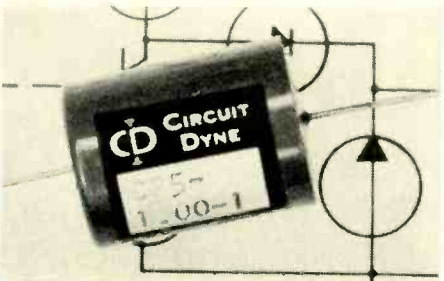

and the CN-5, nonpolarized, are available in current ratings from 1 to 20.5 ma in 5% increments. Leads may be specified axial or single-ended. The device is made by CircuitDyne Corp.

Safer, Shorter CRT's

Here's a new batch of TV picture tubes (19- and 23-inch) with single-panel windows, impregnated glass-fiber coating around the funnel, and steel bands around the periphery of the tube face.

The coating keeps the tube from turning into flying shrapnel in case of a break, and the steel bands keep stress



off the window. Tests made by Underwriters Labs verify that these tubes evacuate safely instead of imploding when cracked, according to Westinghouse, the manufacturer. No protective glass shielding is necessary, and the tubes are up to a half-inch shorter than conventional types.

The maker says that all standard electron-gun designs will soon be available in the new tube design.

8414

This is a sharp-cutoff subminiature vhf pentode intended especially for airborne equipment. Its plate and screen, as well as its heater, are made for 26.5-volt service. The Sylvania 8414 is de-

signed to give dependable service under severe shock, high temperature and altitude, and vibration. It offers an unusually high transconductance for this kind of tube.

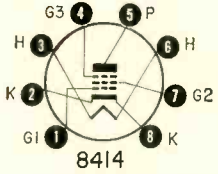

A few of its more important characteristics:

Plate volts	26.5
Grid No. 2 volts	26.5
Grid No. 1 resistor	2.2 meg
Grid No. 3 volts	0
Plate current	4.5 ma
Grid No. 2 current	1.5 ma
Transconductance	5,000 μ mhos
Plate resistance	50,000 ohms (approx)
Grid No. 1 bias for 10 μ a plate current	-4.0 v

5KE8, 6KE8

The 'KE8 triode-pentodes differ only in heater rating (RCA "dark heaters", both). They're meant for TV oscillator-mixer service, and come in a standard

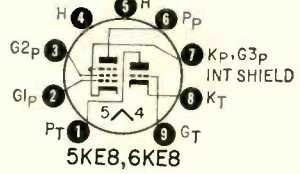

9-pin miniature envelope. The pentode section features high transconductance and frame-grid structure.

Characteristics, class A:

	Triode	Pentode
E_{b1}	125	125 v
E_{g2}	—	125 v
E_{g1}	0	0
R_k	68	33 ohms
μ	40	—
R_p (approx)	5,000	125,000 ohms
g_m	8,000	12,000 μ mhos
I_p	13	10 ma
I_{g2}	—	2.8 ma

END



"Stereo my foot. You're just wearing those so you can't hear me!"

FREE! FOR

'63

LAFAYETTE RADIO ELECTRONICS

1963 CATALOG NO. 630
388 GIANT-SIZE PAGES —

The Largest Catalog in Our 42-Year History

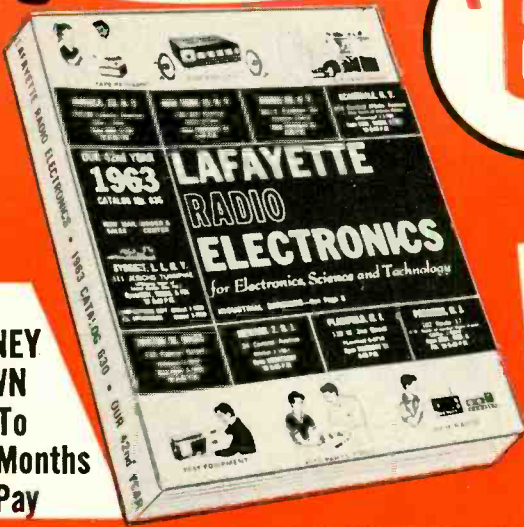

NO MONEY DOWN
Up To
24 Months
To Pay

from the
"WORLD'S
HI-FI
&
ELECTRONICS
SHOPPING
CENTER"

WHEN YOU BUY AT LAFAYETTE, YOU GET THESE EXCLUSIVE BENEFITS

- ★ OUTSTANDING LAFAYETTE KITS
- ★ LOWEST PRICES
- ★ 24-HOUR SERVICE

- SATISFACTION GUARANTEED OR MONEY REFUNDED. Use Lafayette's 30-Day FREE Home Trial.
- LARGEST STOCK SELECTION. If it's in Hi-Fi or Electronics, it's in the Lafayette Catalog.
- NO MONEY DOWN. Buy on time with Lafayette's Easy Pay Credit Plan, up to 24 months to pay.

TRUE, CUSTOM MATCHED STEREO COSTS LESS AT LAFAYETTE

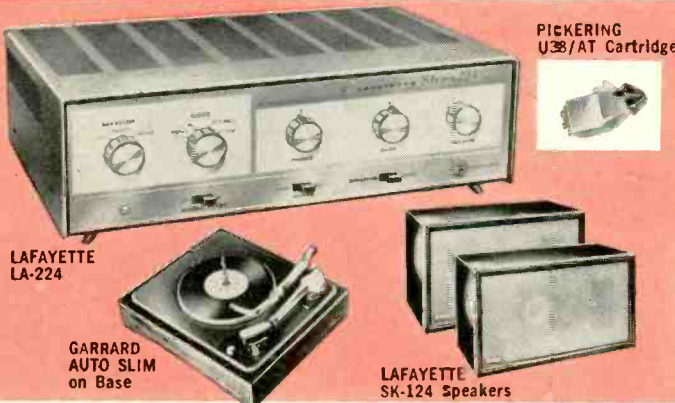

LAFAYETTE LA-224

GARRARD AUTO SLIM on Base

LAFAYETTE SK-124 Speakers

PICKERING U38/AT Cartridge

NEW LAFAYETTE DELUXE PROFESSIONAL QUALITY 4-TRACK STEREO TAPE DECK



RK-140WX

Records Sound-on-Sound
Built-in Transistorized
Stereo Record/Play Preamps

Shown with optional case

99⁵⁰

NO MONEY DOWN

A truly outstanding tape recorder/reproducer. Superb electronics, smooth, dependable tape transport. Plugs into your hi-fi system.
■ Plays: 4-track & 2 track stereo; 4-track, 2-track and full track mono; ■ Records: 4-track stereo or mono; ■ Sound-on-Sound; ■ Freq. response 40-18,000 cps @ 7½ ips; ■ Complete with cables and empty reel.

RK-143WX as above but with carrying case Net 114.50

Only at Lafayette could you find an outstanding, custom-matched stereo system at such an amazing low price. System includes: a powerful Lafayette LA-224 24-watt stereo amplifier with complete stereo controls; a 4-speed Garrard Autoslim automatic/manual record changer with a Pickering U/38AT cartridge and 2 Lafayette SK-124 2-way speaker systems for gigantic full size performance. Compare components, compare price — you'll choose Lafayette.

LS-225WXM specify: Pickering cartridge; wood base finish (walnut, Mhg. or Blonde); Speaker system finish (walnut or Mhg.). Shpg. wt., 64 lbs. Net 129.50

COMPLETE SYSTEM ONLY

129⁵⁰

NO MONEY DOWN

MAIL THIS COUPON TODAY for YOUR FREE LAFAYETTE 630 CATALOG

Get One for a Friend Too

LAFAYETTE RADIO ELECTRONICS

Dept. JD-3, P.O. Box 10, Syosset, L.I., N.Y.

Rush my FREE 388-page giant-size Lafayette Catalog

Send me #....., Shipping charges collect.

I am enclosing

Name

Address

City Zone State

Friend's Name

Address

City Zone State

FREE!



388 GIANT SIZE PAGES

LAFAYETTE'S MAIL ORDER and SALES CENTER
SYOSSET, L. I., NEW YORK
111 Jericho Turnpike

NEW YORK, NEW YORK
100 6th Avenue

JAMAICA, NEW YORK
165-08 Liberty Avenue

BRONX, NEW YORK
542 E. Fordham Rd.

OTHER LOCATIONS
SCARSDALE, NEW YORK
691 Central (Park) Ave.

PLAINFIELD, NEW JERSEY
139 W. 2nd Street

NEWARK, NEW JERSEY
24 Central Avenue

PARAMUS, NEW JERSEY
182 Route 17

BOSTON MASS.
110 Federal Street

NATICK, MASS.
1400 Worcester Street

PROFESSIONAL
technicians
use
Dave Rice's
OFFICIAL
ORDER BOOKS
for every
TV-RADIO
service
call

This is the businesslike approach to service record keeping. Triplicate forms serve as order form, invoice and office record, with spaces for complete information on every job. Separate listings for receiving tubes, pix tube, parts, serial numbers, labor and tax charges, signatures, etc. 75¢ a book, \$6.50 for dust-proof box of 10. In stock at your distributor.

* * * *

FREE

Write for your free folder describing Dave Rice's OFFICIAL ORDER BOOKS, including an actual size sample copy of the handy order form.

ELECTRONIC PUBLISHING CO., INC.
133 N. JEFFERSON ST.
CHICAGO 6, ILLINOIS



NO FREE premiums
NO PRIVATE labels
NO ineffective liquids
or carbon tet
ALL YOU GET IS
GENUINE
"NO NOISE"
QUALITY

- * formulas developed by chemists
- * 14 years of recognized leadership

BEWARE OF
CHEAP
IMITATIONS
INSIST ON
NO-NOISE



- VOLUME CONTROL and Contact Restorer
- TUNER-TONIC for all tuners including wafer type
- FORMULA EC-44 for all electrical contacts

PLUS FREE with all No-Noise products, 5" plastic extender push-button assembly for pin-point applications. Does not cause shorts!

ELECTRONIC CHEMICAL CORP.

813 Communipaw Avenue Jersey City 4, N. J.

TECHNICIANS'

NEWS

Taxes and "Bait" in Pennsylvania

Harrisburg, Pa.—The Pennsylvania Federation of Television and Radio Service Associations has decided to seek clarification of the 4% state sales tax as it applies to labor and parts on warranty service.

The law is apparently not clear on the subject. Most of the time the service firm pays the tax, and yet the tax money is not included in the reimbursements from manufacturers and distributors. Because of the inconsistencies in the law, the group is seeking a definite ruling.

Veiled "bait" advertising in the yellow pages has also come under the FTRSAP's scrutiny, as it has in California and several other states (RADIO-ELECTRONICS, March 1963, page 93).

ESFETA Opposes Warranties

New York—The Empire State Federation of Electronic Technicians Associations, Inc., meeting in executive session at the Hotel Syracuse, Syracuse, N. Y., Jan. 20, 1963, passed the following motion: "ESFETA goes on record opposing manufacturers' extended warranties."

Max Leibowitz, liaison chairman, welcomes correspondence from all local, state and national electronic technicians' associations so that the activities of ESFETA can be coordinated with those of other interested groups. Mr. Leibowitz can be contacted at 2409 41st St., Astoria 3, N. Y.

Blue Ridge Hamfest

Greenville, S. C.—"Y'all come!" says the Blue Ridge Radio Society—their annual hamfest will be held on Sunday, May 5, at Paris Mountain State Park in Greenville. Tickets (which may be obtained there or in advance) are \$3 for adults and \$1.50 for children.

New National Group

Pittsburgh, Pa.—The nucleus of a new national radio and TV service organization, the National Electronic Associations of the United States, met in Columbus, Ohio to discuss future plans.

Twelve states were represented at the meeting by about 60 delegates and proxies (Minn., Mich., Calif., Kan., Iowa, Ind., Ohio, Penna., Texas, Ark. Ore., and Wash.). Elected president *pro*

tem was Gregory Barkoukis, Akron, Ohio.

The ultimate purpose of the new organization will be the "elevation of the trade by working with and through manufacturers and distributors for the betterment of the entire industry".

FTRSAP Elects Officers

Harrisburg, Pa.—Pennsylvania's Federation of Television & Radio Service Associations re-elected Francis X. Finn of Philadelphia as president. The new vice president is Albert Kuhns of State College. Adam Deets, Kingston; L. J. Helk, Carbondale, and L. B. Smith, Hershey, were each re-elected to their former posts of recording secretary, corresponding secretary and treasurer.

The organization presented a plaque to Dave Krantz, who founded the federation in 1948, for his work in founding service associations in Pennsylvania.

FTRSAP joined with several other organizations in the country in protesting misleading classified phone directory advertising and the use of extended warranties as sales gimmicks.

St. Louis BBB Appoints TV Service Adviser

St. Louis—John O'Brien, President of the Better Business Bureau, has appointed Morton Singer (Schweig Engel Co.) trade adviser to the Bureau, representing the Television Service Industry of the Greater St. Louis Area.

The first action of the new liaison will be to review St. Louis' TV service Code of Advertising Ethics, in effect now for four years. Next will come a close working agreement between the TV sales and service industry and the BBB, in an attempt to enhance the industry's status with the public.

Judge Asks Consumer Protection

Seattle—Judge Evans O. Manolides, Seattle justice, stated in his closing remarks at the end of the preliminary hearing on *Washington vs Larry Allen* (R-E, March 1963, page 91) that the state should protect the consuming public by enacting suitable legislation to control TV service rackets.

Allen, charged with petty fraud, testified that he had been instructed by his firm to write up repair bills as large as possible. He pleaded not guilty. Allen also testified that while on the service call (the one that resulted in a complaint to the BBB and his arrest), he removed the rectifiers from the set and took them to a local appliance store to have them tested. "Removal and cleaning" of the rectifiers was itemized later as part of the service charge.

An expert witness testified that only one of the three tubes charged to the set owner was actually replaced,

New Heavy Duty RFI Suppression Kit For Mobile Radio



RADIO HAMs, fleet owners, and CB operators can now enjoy clearer, more readable, less tiring mobile communications at longer effective ranges.

Sprague's new Type SK-1 SUPPRESSIKIT provides effective R-F Interference suppression—at moderate cost—up through 400 megacycles. Designed for easy installation on automobile, truck, or boat engines with either 6-volt or 12-volt generators, the Suppressikit makes possible high frequency interference control by means of Sprague's new, extended range, Thru-pass® capacitors.

The components in the SK-1 Suppressikit are neatly marked and packaged, complete with easy-to-follow installation instructions. All capacitors are especially designed for quick, simple installation.

The generator capacitor is a heavy-duty unit rated at 60 amperes, and will operate at temperatures to 125°C (257°F). This means you'll have no trouble with an SK-1 installation in the terrific temperatures found "under the hood" on a hot summer's day. There's no chance of generator failures from capacitor "short outs," as with general purpose capacitors. The Thru-pass capacitors for use on voltage regulators are also rated at a full 60 amperes.

The Deluxe Suppressikit is furnished complete with an 8-foot shielded lead on the generator capacitor which can be trimmed to necessary length for any car or small truck, preventing R-F radiation from armature and field leads.

Containing only 5 easy-to-install capacitors, the Deluxe Suppressikit is a well-engineered kit. The net price is a little higher than that of many thrown-together kits, but it saves you so much time and aggravation it's well worth the slight extra cost.

For additional information on the Type SK-1 Suppressikit, see your Sprague Electronic Parts Distributor.

65-341 R2

APRIL, 1963

Sprague TWIST-LOK® Capacitors give you 2 tremendous advantages over all other twist-prong electrolytics

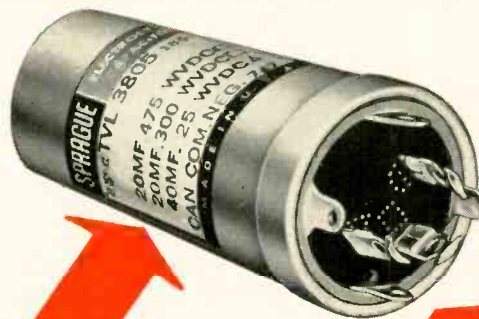

1

**The right size,
the right rating, for
EVERY replacement job**

No need to compromise or improvise...the TWIST-LOK Line includes over 1690 different capacitors . . . It's the industry's most complete selection of twist-prong type capacitors, bar none!

2

**Exclusive, improved
cover design for
greater dependability**

Type TVL Twist-Lok Capacitors are now more dependable than ever! Sprague's new cover design provides a truly leak-proof seal and permits capacitors to withstand higher ripple currents.

Compare internal construction of TWIST-LOK to ordinary 'Lytic!

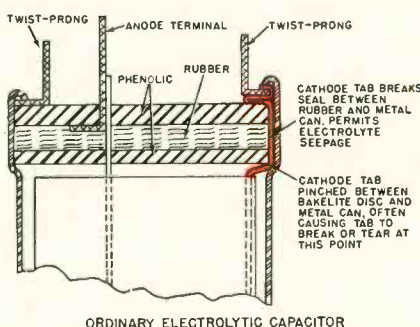

ORDINARY ELECTROLYTIC CAPACITOR

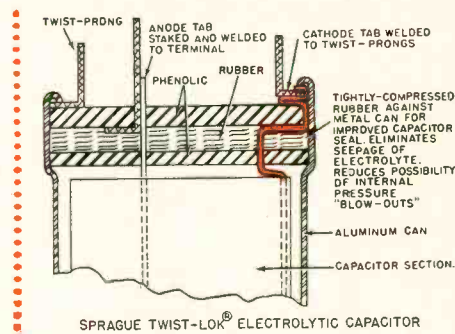

SPRAGUE TWIST-LOK® ELECTROLYTIC CAPACITOR

Get your copy of Sprague's comprehensive *Electrolytic Capacitor Replacement Manual K-106* from any Sprague Distributor, or write to Sprague Products Company, 81 Marshall St., North Adams, Mass.

WORLD'S LARGEST

MANUFACTURER OF CAPACITORS



and that that one was coded with an expiration date over 4 years earlier. He also mentioned "unnecessary and unusual work" done on the set, and the workmanship was amateurish and sloppy.

Allen said that his firm required him to own his stock of tubes, and that he had to give the company 50% of all money left after he had taken out his cost on the tubes.

He quit a few days after making the call that aroused the BBB to action, because of complaints about excessive charges and callbacks for unsatisfactory work. He is now a landscape gardener.

Licensing

According to *TESA News*, St. Louis, the Indiana Electronic Service Association will try for a state bill to license service shops and technicians in the next legislature.

TESA News also reports "rumblings" that New Mexico is about to do the same.

The police department of Kansas City, Mo., announced recently that it will begin arresting TV and radio men who do not have the license called for by city ordinance. This license law was upheld not long ago by the Appeals Court in Kansas City. The case may go to the Missouri Supreme Court, but in

the meantime, says the City Attorney of Kansas City, the law will be enforced.

In Wisconsin, Too

TESA of Wisconsin announces that it is ready to move with its Licensing Bill for the State of Wisconsin. The Licensing Committee met on Dec. 12 to draft the bill in its final form. The group has engaged Richard Gordon of Madison as legal counsel to assure proper procedure.

A comprehensive poll undertaken by TESA of Wisconsin, throughout the state, brought back a 90% affirmative response and encouraged the members to carry on.

TV Fees Rise in KC

Kansas City—TESA of KC reports that several TV service firms in the area have raised their home service fees to between \$5.50 and \$7, from older \$5 to \$6 rates. This is the first significant increase in call rates since around 1950, despite cost increases of over 30%, says *TESA News*.

The rise is attributed to dwindling parts sales and rising overhead. Do-it-yourselfers have cut heavily into service profits, along with drugstore tube checkers and the greater reliability of most TV parts.

King Camden, president of TESA, said that subsidization of service through parts is gone forever. A firm's service fee will have to be determined by its service volume against its overhead.

Seattle Broadcasts Praised

A series of broadcasts produced and aired by KIRO radio, Seattle, has received enthusiastic praise from the King County Television Service Association (Seattle area), and from Frank Moch, executive director of NATESA. "The Two-Eyed Monsters" exposed TV service racketeering in a way Moch called "judicious, informative and fair."

Public reaction to the programs has been tremendous, according to Seattle's *TSA Service News*. Many shops reported favorable comment from customers, and one of the outfits of the kind being "hit" by the broadcasts is said to have complained that its calls had fallen off to three a day.

While the series inevitably affects the business of honest shops by casting some suspicion on the entire service business, the programs emphasized that there is a difference between decent firms and fly-by-night operations.

Tapes of the entire series have been furnished to service associations in nearby states. END

ONLY \$995 EACH

FUN-TO-BUILD knight-kit®



WALKIE-TALKIE

C-100 ALL-TRANSISTOR 2-WAY TRANSCEIVER KIT

Now! Enjoy real on-the-go communication between two or more stations up to ¼ mile! Just press the button and you're "on-the-air." No license or exam required, no age limit. Operates up to 75 hours on low-cost battery. Handsome blue case, only 5 3/8 x 2 1/8 x 1 3/4"; telescoping 40" antenna. A breeze to build. Includes all parts, solder, easy wiring instructions (less battery). Wt., 9 ozs.

83 Y 804 EL. Walkie-Talkie Kit. **\$995**
 Each only.....
 83 Y 013. Leatherette Carrying Case.....**98¢**
 83 Y 002. 9-Volt Battery.....**21¢**

ALLIED RADIO- ORDER TODAY

100 N. Western Ave., Chicago 80, Ill.

Ship me: Walkie-Talkie Kit(s) 83 Y 804 EL.
 Carrying Case(s) 83 Y 013
 9 V. Battery(ies) 83 Y 002

\$.....enclosed check money order

Name _____
 PLEASE PRINT

Address _____

City _____ Zone _____ State _____

SAVE MONEY **HI-FI COMPONENTS**
TAPE RECORDERS
SLEEP LEARN KITS

MERITAPE Low cost, high quality recording tape, in boxes or cans.

DRESSNER FREE 1963 CATALOG

1523 JERICHO TPKE.
 NEW HYDE PARK 17, N.Y.

free... information on the world's happiest hobby!

ASSEMBLE IT AT HOME

THE *Artisan*

ELECTRONIC ORGAN KITS
 for home, school, church, clubs.

The Original "Build-it-Yourself" Organ
 sounds like a glorious pipe organ

SAVE 70% up to

Anyone Can Do It! Here's What You Get

Manuals & Couplers, Tone Generator, Tone Changers, Pedal Keyboards, Consoles

Mail coupon below, and receive... absolutely FREE complete information on Artisan's new 1963 Organ-Building Kit! Illustrated instructions lead you through every step of this happy hobby, as you assemble-at-home a magnificent custom Artisan electronic organ — the best in tone and styling! No technical skill required, and you save up to 70% of comparable ready built organ costs by skipping dealer profits and factory labor! You can play as you build and pay as you build. From \$1750 to \$7500. Write today!

ARTISAN ORGANS 2476 R N.Lake Ave., Altadena, Calif.

NAME _____
 ADDRESS _____
 CITY _____ ZONE _____ STATE _____

TV CAMERA \$99.50

Basic Parts Kit

Details: FREE FLYER No. 771



DENSON ELECTRONICS CORP.
 Rockville, Connecticut

Convert any television to sensitive

BIG-SCREEN OSCILLOSCOPE
 with minor, inexpensive changes. Ingenious circuit. No electronic experience needed to follow our clearly illustrated plans. **TECHNICIANS, HAM'S, EXPERIMENTERS, BROADCASTERS.** Use in shop, school, lab. Any set—any size screen.

FULL PLANS \$2.
RELCO, Dept. RE-4, Box 10563, Houston 18, Tex.

COMPONENTS, TAPE RECORDERS

Write for our low quotes on your choice of components. Save more on "pkgs"! All factory sealed. Send for "Monthly Specials" bulletin.

HI-FI RECORDING TAPE
 with 15 day money-back guarantee

	3-11	12-23	24"
1200' 7" mylar or acetate	\$1.09	\$1.05	5.98
1800' 7" mylar	1.88	1.79	1.75
1800' 7" acetate	1.49	1.39	1.29
2400' 7" mylar	2.59	2.25	1.99
2400' 7" tensilized mylar	2.89	2.84	2.79

Can Be Assorted. Add 15¢ Postage Per Reel, 10¢ for 24 lots

125-RD East 88 St., New York 28, N. Y.

CARSTON Studios

NEW LITERATURE

CATALOGS • BOOKLETS • CHARTS

HIGH-TEMPERATURE WIREWOUND RESISTORS described in 4-page illustrated *Bulletin P-7*. Gives typical inductance values for each type, lists resistance values available with special temperature coefficients. Charts detail resistance change with ambient temperature and load for special TC resistors, design data for calculating cold and hot values.—**International Resistance Co.**, 401 N. Broad St., Philadelphia 8, Pa.

SPEAKER SYSTEMS, 1963 *Sterling Series*. 4-page brochure pictures and describes one bookshelf and three slim (5 inches deep) enclosures. Complete specs.—**Anglo-American Acoustics Ltd.**, 129 Maryland Ave., Freeport, N. Y.

GUIDE TO BETTER FM STEREO PERFORMANCE. 8-page, 5 1/2 x 7 1/2-in. booklet. Drawings and text show importance of FM stereo-engineered outdoor antenna.—**JFD Electronics Corp.**, 6101 16th Ave., Brooklyn 4, N. Y.

4-POLE, HALF-SIZE CRYSTAL CAN RELAY, Type SR, shown in 2-page bulletin. Dimensioned drawings show case and header styles available, electrical schematic of relay. Complete electrical and mechanical specs.—**Branson Corp.**, 41 S. Jefferson Rd., Whippany, N. J.

TUBING SELECTION CHART. 8 1/2 x 11-in. chart shows range of wire and cable diameters covered by various types and sizes of heat-shrinkable tubing.—**Alpha Wire Corp.**, 200 Varick St., New York 14, N. Y.

TRANSISTOR PRICE LIST includes 80 types of power transistors, plus silicon high-frequency, germanium high-frequency types. Offers six types of silicon-controlled rectifiers.—**Motorola Semiconductor Products, Inc.**, 5005 E. McDowell Rd., Phoenix 8, Ariz.

COIL FORM CATALOG. 4-page *Bulletin CO-8* details series XR-50, 60, 70, 80, 90 and new series XR-100. Complete specs, descriptions, break-away illustrations, photos, engineering drawings on each series.—**National Radio Co.**, Dept. P, 37 Washington St., Melrose, Mass.

ELECTRONIC COMPONENTS. 4-page catalog presents constant-voltage transformers, constant-voltage dc power supply, constant-voltage frequency controlled solid state inverter, new *Semco* line. Complete specs, engineering drawings, photos.—**Supreme Electro-Magnetic Co.**, Dept. of Supreme Transformer, 2331 N. Washtenaw Ave., Chicago 47, Ill.

ELECTRONIC/HI-FI COMPONENTS offered in illustrated 40-page *Catalog 623*. Products include uhf converters, transistor code oscillators, 4-band communications receivers, hi-fi stereo amps, transistorized tape recorders, mikes, headphones, stereo components, replacement parts, experimental kits, transistor kits, ac-dc radio kits.—**Philmore Mfg. Co., Inc.**, 130-01 Jamaica Ave., Richmond Hill 18, N. Y.

MOLDED DIODE ASSEMBLIES presented in 4-page foldup booklet. Defines molded diode assembly, explains nomenclature system, lists diodes available for custom-designed molded assemblies. Illustrated with photos, block diagrams.—**Motorola Semiconductor Products, Inc.**, 5005 E. McDowell Rd., Phoenix 8, Ariz.

DIALS, DRIVES, REDUCTION MECHANISMS presented in 8-page *Catalog CO-6*. Offers vernier dials, planetary drive dials, dial locks, micrometer dials, uncalibrated dials, precision drives, right angle drives. Large photo, engineering drawing and complete specs of each item.—**National Radio Co.**, Dept. P, 37 Washington St., Melrose, Mass.

ELECTROLYTIC CAPACITOR REPLACEMENTS listed in 40-page *Manual K-106*. Covers replacements for sets of 256 manufacturers, including TV sets plus home, auto, portable radios made 1947 through 1962. Lists original part numbers, ratings, recommended replacements, list prices. Over 2,450 electrolytic capacitors in all.—**Sprague Products Co.**, 81 Marshall St., North Adams, Mass. 10¢.

MICA DIELECTRIC CAPACITORS, molded, wire-lead type. 12-page bulletin contains complete engineering data, listings for commercial and military units. Illustrated by graphs and charts.—**Sangamo Electric Co.**, Springfield, Ill.

MICROMINIATURE ASSEMBLY TOOLS. 24-page *Bulletin B1* presents precision electronic pliers, superfine tweezers plus drills, taps, dies, pin vises, lathes. Photo and description of over a hundred items.—**Techni-Tool, Inc.**, 1216 Arch St., Philadelphia 7, Pa.

NEON GLOW LAMPS. 4 models illustrated in *Bulletin 110B*. Specs include breakdown voltage dc, maintaining voltage dc, design current, rated life.—**Signalite, Inc.**, Neptune, N. J.

FM-FM TELEMETERING SYSTEM. Catalog sheet describes model 5000 silicon transistor device for data transmission from systems in high acceleration. Photo, typical specs, typical measurement applications.—**Solid State Electronics Co.**, 15321 Rayen St., Sepulveda, Calif.

TERMINAL BOARDS, 16-page catalog *GEA-7317A* covers sectional and 1-piece boards. Complete description and application data, photos and dimension drawings. Details individual blocks, shows user how to make any type of sectional board. Also covers complete boards.—**General Electric Co.**, Schenectady 5, N. Y.

WELDED MODULE EPOXY INSULATION SELECTOR, Bulletin E-107. Chart gives electrical, physical, military specs, arranged in sequence, key properties high-lighted.—**Hysol Corp.**, Olean, N. Y.

PARTS MOTIVATOR described in 4-page illustrated bulletin. Feeds parts to processing or assembling machines. Photos, drawings, detailed text explain applications.—**Automation Devices, Inc.**, 3125 Brandes St., Erie, Pa.

CRYSTAL SPECS. 6-page bulletin gives technical data on A elements in ranges 500-1,400 kc, 1.4-20 mc, 10-125 mc. Covers frequency range, holder numbers, temperature range, frequency tolerance, oven operation, frequency temperature coefficient, maximum effective resistance, typical electrical equivalent parameters, military specs.—**Reeves-Hoffman, Div. Dynamics Corp. of America**, Cherry and North Sts., Carlisle, Pa.

CONDENSER MICROPHONES, Series 4131/6, detailed in 12-page technical bulletin. Many illustrations, complete specs on mikes and cartridges. Individual calibration, free-field corrections, cathode followers, data on measuring, recording, analyzing sound. 5 pages cover accessories.—**B & K Instruments, Inc.**, 3044 W. 106th St., Cleveland 11, Ohio.

POLYESTER FILM DIELECTRIC CAPACITORS outlined in 4-page *Bulletin 524*. Illustrations, complete description. Mechanical and electrical specs.—**Erie Resistor Corp.**, Erie, Pa.

SPECIAL ELECTRON TUBES. 12-page illustrated brochure describes resources, facilities of firm's Electron Tube Dept. Gives details on special electron tube—research and development, test, evaluation, production.—**Electron Tube Dept., CBS Labs**, High Ridge Rd., Stamford, Conn.

DIGITAL DELAY LINES. 12-page manual outlines history, theory, design, application of glass ultrasonic delay lines for digital use. Text defines terms, describes data rates and attenuation, examines delay line response. Many tables and figures.—**Corning Electronic Components**, Corning Glass Works, Raleigh, N. C.

CAPACITOR SELECTION CHART shows 7-step specifying procedure for MIL-C-25 capacitors. 17 x 22-in. wall chart gives terminal types, circuits, temperature characteristics, voltage, capacitance and capacitance tolerance for each of 17 illustrated case styles. 5 types of terminal construction, 6 typical circuits illustrated in 2 diagrams. Temperature characteristics table cross-references impregnants, operating temperature range, dissipation factors, insulation resistance, temperature coefficients with MIL-C-25 characteristics E, F and K. Voltage and capacitance ratings given for various MIL-C-25 designations.—**Cornell-Dubilier Electronics**, 50 Paris St., Newark 1, N. J. END

Any or all of these catalogs, bulletins, or periodicals are available to you on request direct to the manufacturers, whose addresses are listed at the end of each item. Use your letterhead—do not use postcards. To facilitate identification, mention the issue and page of RADIO-ELECTRONICS on which the item appears. UNLESS OTHERWISE STATED, ALL ITEMS ARE GRATIS. ALL LITERATURE OFFERS ARE VOID AFTER SIX MONTHS.

With any \$10 order you get

F DOUBLE F

R "BONUS" R

E #1 \$25.00 WORTH OF RADIO-TV PARTS

E #2 \$1 CHOOSE ANY \$1 ITEM LISTED BELOW FREE

BOTH FREE WITH EVERY \$10.00 ORDER
POLY PAKS WORTH \$3.00 TO \$50.00

WORLD'S BEST "DOLLAR" BUYS

- | | |
|--|--|
| <input type="checkbox"/> 10 RCA PLUG-IN JACK SETS, phono's, amps | <input type="checkbox"/> 5 "HI" Q MAGNETS, 5/8 x 3/8 |
| <input type="checkbox"/> 3 OUTPUT TRANSFORMERS, 50L6, 50C5 | <input type="checkbox"/> 8 POCKET "PIN" STRAIGHTENERS, 7 & 9 prong tubes |
| <input type="checkbox"/> 20 "TINY SWITCHES" GE, like micro, 1.5VAC | <input type="checkbox"/> 50 KNOBS, radio 'n' tv ass't colors, sizes |
| <input type="checkbox"/> 10 TRANSISTOR SOCKETS, for PNP-n-PNPs | <input type="checkbox"/> 50 COILS 'n' CHOKES, 1/4, 1/2, 3/4, 1, 2, 3, 4, 5, 10, 15, 20, 25, 30, 35, 40, 50, 75, 100, 150, 200, 250, 300, 400, 500, 750, 1000 ohms, peak, etc. |
| <input type="checkbox"/> 1500-PC. HARDWARE KIT, screws, etc. | <input type="checkbox"/> 300-FT. HOOKUP WIRE, ass't colors |
| <input type="checkbox"/> 7, 25-FT. ROLLS sub-mini wire #26 to #32 | <input type="checkbox"/> 100 PRINTED CIRCUIT RADIO PARTS |
| <input type="checkbox"/> 8 CHEATER CORDS, rubber plugs TV, 2 | <input type="checkbox"/> \$25 SURPRISE has transistors, diodes, etc. |
| <input type="checkbox"/> 100 PARTS SURPRISE, worth \$50 | <input type="checkbox"/> SIGMA RELAY, sensi-tive, 12K ohms, SPST |
| <input type="checkbox"/> 50 TERMINAL STRIPS, 1 to 8 screw & lug types, ass't | <input type="checkbox"/> 15 PACKAGED ELECTRONIC CIRCUITS |
| <input type="checkbox"/> 60 SOCKETS, plugs, receptacles, phn, tube | <input type="checkbox"/> 4 TRANSISTOR OSCILLATOR COILS |
| <input type="checkbox"/> 10 PANEL SWITCHES, micro, toggle, rotary | <input type="checkbox"/> 2, 4, 5, 6, 7, 8, 9, 10, 11, 12, 13, 14, 15, 16, 17, 18, 19, 20, 21, 22, 23, 24, 25, 26, 27, 28, 29, 30, 31, 32, 33, 34, 35, 36, 37, 38, 39, 40, 41, 42, 43, 44, 45, 46, 47, 48, 49, 50, 51, 52, 53, 54, 55, 56, 57, 58, 59, 60, 61, 62, 63, 64, 65, 66, 67, 68, 69, 70, 71, 72, 73, 74, 75, 76, 77, 78, 79, 80, 81, 82, 83, 84, 85, 86, 87, 88, 89, 90, 91, 92, 93, 94, 95, 96, 97, 98, 99, 100, 101, 102, 103, 104, 105, 106, 107, 108, 109, 110, 111, 112, 113, 114, 115, 116, 117, 118, 119, 120, 121, 122, 123, 124, 125, 126, 127, 128, 129, 130, 131, 132, 133, 134, 135, 136, 137, 138, 139, 140, 141, 142, 143, 144, 145, 146, 147, 148, 149, 150, 151, 152, 153, 154, 155, 156, 157, 158, 159, 160, 161, 162, 163, 164, 165, 166, 167, 168, 169, 170, 171, 172, 173, 174, 175, 176, 177, 178, 179, 180, 181, 182, 183, 184, 185, 186, 187, 188, 189, 190, 191, 192, 193, 194, 195, 196, 197, 198, 199, 200, 201, 202, 203, 204, 205, 206, 207, 208, 209, 210, 211, 212, 213, 214, 215, 216, 217, 218, 219, 220, 221, 222, 223, 224, 225, 226, 227, 228, 229, 230, 231, 232, 233, 234, 235, 236, 237, 238, 239, 240, 241, 242, 243, 244, 245, 246, 247, 248, 249, 250, 251, 252, 253, 254, 255, 256, 257, 258, 259, 260, 261, 262, 263, 264, 265, 266, 267, 268, 269, 270, 271, 272, 273, 274, 275, 276, 277, 278, 279, 280, 281, 282, 283, 284, 285, 286, 287, 288, 289, 290, 291, 292, 293, 294, 295, 296, 297, 298, 299, 300, 301, 302, 303, 304, 305, 306, 307, 308, 309, 310, 311, 312, 313, 314, 315, 316, 317, 318, 319, 320, 321, 322, 323, 324, 325, 326, 327, 328, 329, 330, 331, 332, 333, 334, 335, 336, 337, 338, 339, 340, 341, 342, 343, 344, 345, 346, 347, 348, 349, 350, 351, 352, 353, 354, 355, 356, 357, 358, 359, 360, 361, 362, 363, 364, 365, 366, 367, 368, 369, 370, 371, 372, 373, 374, 375, 376, 377, 378, 379, 380, 381, 382, 383, 384, 385, 386, 387, 388, 389, 390, 391, 392, 393, 394, 395, 396, 397, 398, 399, 400, 401, 402, 403, 404, 405, 406, 407, 408, 409, 410, 411, 412, 413, 414, 415, 416, 417, 418, 419, 420, 421, 422, 423, 424, 425, 426, 427, 428, 429, 430, 431, 432, 433, 434, 435, 436, 437, 438, 439, 440, 441, 442, 443, 444, 445, 446, 447, 448, 449, 450, 451, 452, 453, 454, 455, 456, 457, 458, 459, 460, 461, 462, 463, 464, 465, 466, 467, 468, 469, 470, 471, 472, 473, 474, 475, 476, 477, 478, 479, 480, 481, 482, 483, 484, 485, 486, 487, 488, 489, 490, 491, 492, 493, 494, 495, 496, 497, 498, 499, 500, 501, 502, 503, 504, 505, 506, 507, 508, 509, 510, 511, 512, 513, 514, 515, 516, 517, 518, 519, 520, 521, 522, 523, 524, 525, 526, 527, 528, 529, 530, 531, 532, 533, 534, 535, 536, 537, 538, 539, 540, 541, 542, 543, 544, 545, 546, 547, 548, 549, 550, 551, 552, 553, 554, 555, 556, 557, 558, 559, 560, 561, 562, 563, 564, 565, 566, 567, 568, 569, 570, 571, 572, 573, 574, 575, 576, 577, 578, 579, 580, 581, 582, 583, 584, 585, 586, 587, 588, 589, 590, 591, 592, 593, 594, 595, 596, 597, 598, 599, 600, 601, 602, 603, 604, 605, 606, 607, 608, 609, 610, 611, 612, 613, 614, 615, 616, 617, 618, 619, 620, 621, 622, 623, 624, 625, 626, 627, 628, 629, 630, 631, 632, 633, 634, 635, 636, 637, 638, 639, 640, 641, 642, 643, 644, 645, 646, 647, 648, 649, 650, 651, 652, 653, 654, 655, 656, 657, 658, 659, 660, 661, 662, 663, 664, 665, 666, 667, 668, 669, 670, 671, 672, 673, 674, 675, 676, 677, 678, 679, 680, 681, 682, 683, 684, 685, 686, 687, 688, 689, 690, 691, 692, 693, 694, 695, 696, 697, 698, 699, 700, 701, 702, 703, 704, 705, 706, 707, 708, 709, 710, 711, 712, 713, 714, 715, 716, 717, 718, 719, 720, 721, 722, 723, 724, 725, 726, 727, 728, 729, 730, 731, 732, 733, 734, 735, 736, 737, 738, 739, 740, 741, 742, 743, 744, 745, 746, 747, 748, 749, 750, 751, 752, 753, 754, 755, 756, 757, 758, 759, 760, 761, 762, 763, 764, 765, 766, 767, 768, 769, 770, 771, 772, 773, 774, 775, 776, 777, 778, 779, 780, 781, 782, 783, 784, 785, 786, 787, 788, 789, 790, 791, 792, 793, 794, 795, 796, 797, 798, 799, 800, 801, 802, 803, 804, 805, 806, 807, 808, 809, 810, 811, 812, 813, 814, 815, 816, 817, 818, 819, 820, 821, 822, 823, 824, 825, 826, 827, 828, 829, 830, 831, 832, 833, 834, 835, 836, 837, 838, 839, 840, 841, 842, 843, 844, 845, 846, 847, 848, 849, 850, 851, 852, 853, 854, 855, 856, 857, 858, 859, 860, 861, 862, 863, 864, 865, 866, 867, 868, 869, 870, 871, 872, 873, 874, 875, 876, 877, 878, 879, 880, 881, 882, 883, 884, 885, 886, 887, 888, 889, 890, 891, 892, 893, 894, 895, 896, 897, 898, 899, 900, 901, 902, 903, 904, 905, 906, 907, 908, 909, 910, 911, 912, 913, 914, 915, 916, 917, 918, 919, 920, 921, 922, 923, 924, 925, 926, 927, 928, 929, 930, 931, 932, 933, 934, 935, 936, 937, 938, 939, 940, 941, 942, 943, 944, 945, 946, 947, 948, 949, 950, 951, 952, 953, 954, 955, 956, 957, 958, 959, 960, 961, 962, 963, 964, 965, 966, 967, 968, 969, 970, 971, 972, 973, 974, 975, 976, 977, 978, 979, 980, 981, 982, 983, 984, 985, 986, 987, 988, 989, 990, 991, 992, 993, 994, 995, 996, 997, 998, 999, 1000 |

CONDENSERS

- | | |
|---|--|
| <input type="checkbox"/> 10 TUBULAR ELECTROLYTIC to 450V | <input type="checkbox"/> 60 CERAMICS, discs, npo's, etc. to .05 mf |
| <input type="checkbox"/> 60-PC. SURPRISE discs, tubulars, mica's electro, oil, ceramics | <input type="checkbox"/> 20 TRANSISTOR SQUARES, .01 to .05mf |
| <input type="checkbox"/> 60 MICAS, 5mmf to .01 mf, silvers, too | <input type="checkbox"/> 40 SUBMINIATURES, paper, mica's, ceramics |
| <input type="checkbox"/> 10 ELECTROLYTICS to 600V, FP's & tubular | <input type="checkbox"/> 30 PLASTIC-PORCELAIN-TANTALUMS, ass't |
| <input type="checkbox"/> 35 SILVER MICAS, "red" case'd, hi stability | <input type="checkbox"/> 100 CERAMICS, tubular, ass't values |
| <input type="checkbox"/> 40 ASST DISCS, 27mmf to .05 to 6KV | <input type="checkbox"/> 60 TUBULARS, .0002mf to 600V |
| <input type="checkbox"/> 10 TRANSISTOR ELECTROLYTICS, ASST | <input type="checkbox"/> 40 TEMPERATURE COMPENSATING CERAMICS, npo's, n-750s |

RESISTORS

- | | |
|---|--|
| <input type="checkbox"/> 10 VOLUME CONTROLS to 1 meg, sw. too | <input type="checkbox"/> 40 WORLDS SMALL-EST, A-B, 5% too |
| <input type="checkbox"/> 100 HALF WATTERS, A-B, 5% too | <input type="checkbox"/> 25 POWERS, 5-50W, to 7K ohms, vitreous, etc |
| <input type="checkbox"/> 35 PRECISIONS, 1/2, 1, 2W, 1% and better | <input type="checkbox"/> 15 HALF PERCENT-ERS, 1/2, 1, 2W, Mepco |
| <input type="checkbox"/> 60 CARBONS, 1/2, 1, 2W, A-B, 5% too | |

TRANSISTORS

- | | |
|---|---|
| <input type="checkbox"/> 15 NPNS, TO-5 case | <input type="checkbox"/> 2 40-WATTERS, 2N174 case, stud |
| <input type="checkbox"/> 20 PNP, TO-5 case | <input type="checkbox"/> 10-PC. SET, 5 PNP SET and 5 NPN |
| <input type="checkbox"/> 15 CK722, PNP | <input type="checkbox"/> TEN 100mc PNP WADTS |
| <input type="checkbox"/> 4 2N355, NPN | <input type="checkbox"/> 5 POWERS, 2N155, TO3 chrome case |
| <input type="checkbox"/> 4 2N1075, PNP | <input type="checkbox"/> 6 PRINTED CIRCUIT TYPES and boards |
| <input type="checkbox"/> CHOOSE ANY TWO: 2N241; 2N410; 2N412; all pnp | |
| <input type="checkbox"/> 25-amp CAR IGNITION, TO3 case | |

SEMI-KON-DUCTORS

- | | |
|---|--|
| <input type="checkbox"/> 30 "KLIFF-IN" DIODES, type 1N119 | <input type="checkbox"/> 10 2-AMP POWER RECTIFIERS, silicon |
| <input type="checkbox"/> 20 TOP HAT RECTIFIERS, 1750 ma | <input type="checkbox"/> 10 ZENER DIODES, silicon regulators |
| <input type="checkbox"/> 15 GERMANIUM DIODES like 1N34 | <input type="checkbox"/> 4 SUN BATTERIES to 1 1/2" sizes |
| <input type="checkbox"/> 15 SILICON DIODES, to 750 ma | <input type="checkbox"/> 25 DIODES, RECTIFIERS, TRANSISTORS |

Send 10¢ for Bargain Mail Order Flyers
 Semiconductors Poly Paks Parts

POLY PAKS

TERMS: include postage, check, money order, EXPORT ORDERS INVITED. Wt. per pak 1-lb.

P.O. BOX 942R
S. LYNNFIELD, MASS.

World's Largest Supplier of Pre-Packed Assortments

Technotes

Early Raytheon (C-1401, etc.)

Several sets have come in with the same trouble: no sound or pictures, .25-amp fuse blown, 5U4-G out. After checking the power supply, trouble was found in the bifilar transformer coupling the 6AU6 fourth video i.f. amplifier to

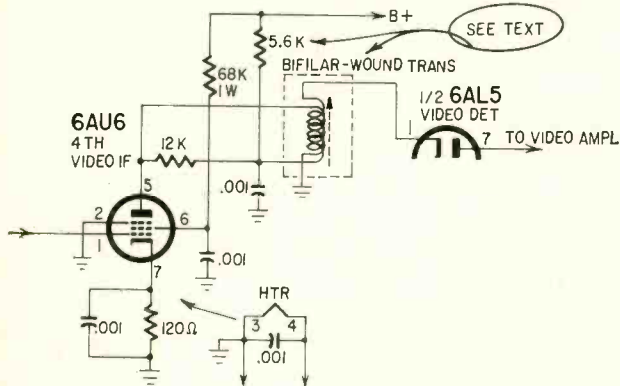

the video detector. A short between windings allowed the full output of the power supply to be fed to ground through the 5,600-ohm plate decoupling resistor, which decreased to 100 ohms under the load.

Replacing the coil and resistor, the set worked well but

plate voltage on the 6AU6 was high. Replacing the 5,600-ohm resistor with a 10,000-ohm, 10-watt unit brought the plate voltage to normal.—G. B. Anglado

Crosley 473

Complaint: Picture displaced three to four inches to the right, with slight loss of brightness. The trouble occurs after thirty minutes running time. All parts test OK. The trouble will probably be in the agc keying winding on the horizontal output transformer.

Double check by disconnecting the ground tap and the pulse lead to the keyer tube. Substitute a 3-volt negative battery to the agc line.—William Porter

Philco E-670/E-676

Some of these sets go into spurious oscillation apparently because of poor soldering between speaker and chassis.

To eliminate this complaint, scrape a clean, shiny spot on the chassis near the speaker and solder a flexible wire to it. Solder the other end of the wire to the metal speaker mounting, and you have a thorough ground path.—A. von Zook

Replacement for the 5MK9 Rectifier

You can substitute a 6X4 rectifier for the 5MK9 by rewiring the socket, and connecting the 6X4 cathode to its heater and both plates together, as shown in Fig. 1.

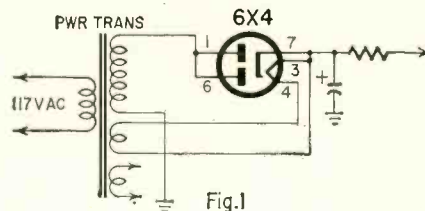

Fig. 1



"Messenger" CB Transceivers...rated BEST in Nation by Electronic Distributor Salesmen*

*New impartial survey by leading electronic magazine shows Johnson "Messenger" Transceivers rated "BEST"—BEST BY NEARLY 50% OVER SECOND CHOICE BRAND.

4 feature-packed "Messengers"... and Selective Call System outperform everything!

Compact, Hand-Held—100 milliwatt or 1 watt "Personal Messengers". Rugged and reliable—11 transistors, 4 diodes! Twice the sensitivity and 40% more range than similar units with conventional circuitry—more output than similar units with same rated inputs!

Mobile or Base Stations—performance proved Viking "Messenger" and new "Messenger Two". Punches your signal across the miles—high efficiency design makes full use of maximum legal power. Excellent receiver sensitivity and selectivity. Automatic "squelch" control—5 or 10 channel coverage—easy to install anywhere!

Tone Alert—37 tone selective call system mutes speakers until one unit calls another—then automatically your stations receive audio note and indicator light flashes "On".



NEW! 4-color BROCHURE—write for your free copy!



E. F. JOHNSON CO.
2502 10th Ave. S.W., Waseca, Minnesota

Please rush "Messenger" details to:

NAME _____
ADDRESS _____
CITY _____ STATE _____

Manufacturers of the world's most widely used personal communications transmitters.

IEEE

SEE

THE NEW
ELECTRONIC
WIZARDRY

at

I-TRIPLE-E's

International Convention
and Exhibition in New York

MARCH 25, 26, 27, 28

The COLISEUM at Columbus Circle
& The WALDORF ASTORIA HOTEL

admission: MEMBERS \$1.00; NON-MEMBERS \$3.00
MINIMUM AGE: 18

SHOW

(formerly the IRE Show)

The lower heater voltage will not have any effect other than lengthening the warmup time a few seconds.



Fig. 2

The 5MK9 is used principally in receivers and recorders manufactured in Japan. There is no standard replacement. Basing diagram for the 5MK9 is in Fig. 2.—*E. L. Deschambault*

Emerson 888

Three points to check when you have intermittents:
 1—On-off switch soldered to printed circuit has broken loose.
 2—Personal listening attachment socket shorting bar does not make good contact.
 3—Penlight battery holder contact springs are loose from contact plate. Solder the springs to the plate or replace the assembly.—*E. Spandorf*

RCA 21CS7815 (CTC5)

Interference signals are sometimes picked up and rectified in the PW200 board and its associated wiring. The result is noise in the audio output of the receiver—sometimes even with the volume turned all the way down.

The signal pickup occurs on the long leads connected to

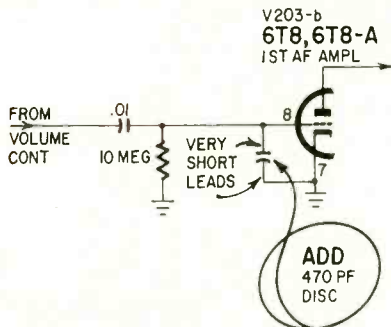

the volume control, and rectification is in the grid circuit of the first audio amplifier. The noise can be killed by inserting a 470-pf capacitor between the grid and cathode of the first a.f. amplifier (V202-6, a 6T8). Be sure to keep leads as short as possible and do not use anything but the cathode terminal of the tube socket for a ground.—*C. S. Lawrence*

Quick Purity Checker

Make a purity checker with just two 100,000-ohm resistors and three alligator clips, plus some plastic tape or rubber covering (see diagram). Clip onto blue and green

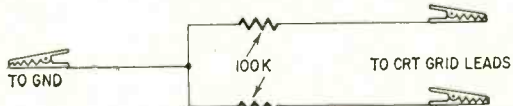

NB—INSULATE ALL LEADS & CLIPS

grids to observe red purity, and change to observe either blue or green purity. This eliminates disturbing CRT tracking by turning down the green and blue screen controls, and the subsequent resetting of these controls.—*A. R. Richman*

Motorola VTS505

Trouble: Picture and sound intermittent, raster constant. No regular recurrence.

Remedy: When trouble occurs, some tube heaters are dimmed. Sparking near filament transformer pointed the way; one transformer wire was soldered to a terminal strip and grounded through the strip's mounting foot. A good soldering job cured the trouble.—*Wade Lockey* END

BECOME A RADIO TECHNICIAN
for only \$26.95

BUILD YOUR RADIO

CIRCUITS AT HOME

with the New Progressive
RADIO "EDU-KIT"®

Reg. U.S.
Pat. Off.

All Guaranteed to Work!

PRACTICAL only
HOME RADIO COURSE \$26.95



NOW INCLUDES

- ★ 12 RECEIVERS
- ★ 3 TRANSMITTERS
- ★ SQ. WAVE GENERATOR
- ★ AMPLIFIER
- ★ SIGNAL TRACER
- ★ SIGNAL INJECTOR
- ★ CODE OSCILLATOR

TRAINING ELECTRONICS
TECHNICIANS SINCE 1946

- ★ No Knowledge of Radio Necessary
- ★ No Additional Parts or Tools needed
- ★ Excellent Background for TV
- ★ School Inquiries Invited
- ★ Attractively Gift Packed

FREE EXTRAS

- SET OF TOOLS • RADIO & ELECTRONICS TESTER • ELECTRIC SOLDERING IRON • TESTER INSTRUCTION MANUAL • MEMBERSHIP IN RADIO-TV CLUB • CONSULTATION SERVICE • HI-FI GUIDE
- QUIZZES • TV BOOK • FCC AMATEUR LICENSE TRAINING
- RADIO BOOK • PRINTED CIRCUITRY • PLIERS-CUTTERS
- ALIGNMENT TOOL • WRENCH SET • CERTIFICATE OF MERIT
- VALUABLE DISCOUNT CARD

WHAT THE "EDU-KIT" OFFERS YOU

The "Edu-Kit" offers you an outstanding PRACTICAL HOME RADIO COURSE at a rock-bottom price. Our kit is designed to train Radio & Electronics Technicians, making use of the most modern methods of home training. You will learn radio theory, construction, servicing, basic Hi-Fi and TV repairs, code, FCC amateur license requirements, the principles which you learn.

THE KIT FOR EVERYONE

The Progressive Radio "Edu-Kit" was specifically prepared for any person who has a desire to learn Radio. The "Edu-Kit" has been used successfully by young and old in all parts of the world, by many Radio Schools and Clubs in this country and abroad. It is used for training and rehabilitation of Armed Forces Personnel and Veterans throughout the world.

PROGRESSIVE TEACHING METHOD

The Progressive Radio "Edu-Kit" is the foremost educational radio kit in the world and is universally accepted as the standard in the field of electronics training. The "Edu-Kit" uses the modern educational principle of "Learn by Doing." Therefore, you will construct radio circuits, perform jobs and conduct experiments to illustrate the principles which you learn.

You begin by examining the various radio parts included in the "Edu-Kit." You then learn the function, theory and wiring of these parts. Then you build a simple radio. With this first set, you will enjoy listening to regular broadcast stations, learn theory, practice testing and troubleshooting. Then you build a more advanced radio, learn more advanced theory and techniques. Gradually, in a progressive manner, and at your own rate, you will find yourself constructing more advanced multi-tube radio circuits, and doing work like a professional Radio Technician.

Included in the "Edu-Kit" course are twenty Receiver, Transmitter, Code Oscillator, Signal Tracer, Signal Injector, Square Wave Generator and Amplifier circuits. These are not unprofessional "breadboard" experiments, but genuine radio circuits, constructed by means of professional wiring and soldering on metal chassis, plus the new method of radio construction known as "Printed Circuitry." These circuits operate on your regular AC or DC house current.

In order to provide a thorough, well-integrated and easily-learned radio course, the "Edu-Kit" includes practical work as well as theory; troubleshooting in addition to construction; training for all, whether your purpose in learning radio be for hobby, business or job; progressively-arranged material, ranging from simple circuits to well-advanced radio circuits. Your studies will be further aided by Quiz materials and our well-known FREE Consultation Service.

THE "EDU-KIT" IS COMPLETE

You will receive all parts and instructions necessary to build 20 different radio and electronics circuits, each guaranteed to operate. Our Kits contain tubes, tube sockets, variable electrolytic, mica, ceramic and paper dielectric condensers, resistors, tie strips, coils, hardware, tubing, punched metal chassis, Instruction Manuals, hookup wire, solder, selenium rectifiers, volume controls, switches, knobs, etc. By additional purchase you receive Printed Circuit materials, including Printed Circuit chassis, special tube sockets, hardware and instructions. You also receive a useful set of tools, a professional electric soldering iron, and a self-powered Dynamic Radio & Electronics Tester. The "Edu-Kit" also includes Code Instructions and the Progressive Code Oscillator. In addition to the F.C.C.-type Questions and Answers for Radio Amateur License training. You will also receive lessons for servicing with the Progressive Signal Tracer and the Progressive Signal Injector, and a High Fidelity Guide and Quiz Book. Everything is yours to keep.

J. Statolis, of 25 Poplar Pl., Waterbury, Conn., writes: "I have repaired several sets for my friends, and made money. The "Edu-Kit" paid for itself. I was ready to spend \$240 for a course, but I found your ad and sent for your Kit."

UNCONDITIONAL MONEY-BACK GUARANTEE

The Progressive Radio "Edu-Kit" has been sold to many thousands of individuals, schools and organizations, public and private, throughout the world. It is recognized internationally as the ideal radio course.

By popular demand the Progressive Radio "Edu-Kit" is now available in Spanish as well as English.

It is understood and agreed that should the Progressive Radio "Edu-Kit" be returned to Progressive "Edu-Kits" Inc. for any reason whatever, the purchase price will be refunded in full, without quibble or question, and without delay.

The high recognition which Progressive "Edu-Kits" Inc. has earned through its many years of service to the public is due to its unconditional insistence upon the maintenance of perfect engineering, the highest instructional standards and 100% adherence to its Unconditional Money-Back Guarantee. As a result, we do not have a single dissatisfied customer throughout the entire world.

ORDER FROM AD—RECEIVE FREE BONUS RESISTOR AND CONDENSER KITS WORTH \$7.00

- Send "Edu-Kit" Postpaid. I enclose full payment of \$26.95.
- Send "Edu-Kit" C.O.D. I will pay \$26.95 plus postage.
- Send me FREE additional information describing "Edu-Kit."

Name: _____
Address: _____

Progressive "EDU-KITS" Inc.

1186 Broadway, Dept. 207G
Hewlett, N. Y.

SILICONS LESS THAN 13¢!

Rectifier Package: 50 top-hats & 50 stud-mts. PIV's range from 50-600, currents 0.3-1.8 A dc. Rejected for Astronauts, unmarked, but large percentage OK for Earth People. You grade them with instructions we include. Guarantee: Grade them within 10 days; if you don't get enough value to delight you, return for refund. Be smart, do your own grading! \$12.95



60 CY AC FROM 12 V DC ... & VICE VERSA!

Combination transistorized Inverter & 12 v battery charger. Ideal for Boats, Camping, Field Trips, Autos. Plugs into 115 v 60 cy to charge battery at 8 amp rate, tapers to 2 amps. Switch to inverter and the 12 v battery supplies 115 v 60 cy (sq wave) for lights, TV, radio, electric drills, etc., anything at all except capacitor-start motors. Thousands sold at double these prices to Automotive trade. This is new material, guaranteed OK, factory over-run, with instruction Booklet.

250 W 2.3 amp int., 200 W 1.8 amp con- tinuous, 15 lbs net for Los Angeles. \$57.50

500 W 4.0 amp int., 300 W 2.5 amp con. Metered. Starts dead cars from 115 v line! \$137.50

(Intermittent use means 15 minutes total in any 1 hour.)

R. E. GOODHEART CO., Inc.
Box 1220-RE Beverly Hills, Calif.



Try This One—for Economy!

Every week we allot each technician a full complement of tubes for his service kit—\$100 worth. And every week we inventory his stock. We're saving money right along.

What used to happen before this strict check was that a technician working on a set in the shop or at a customer's house might replace suspected tubes with new ones from his kit. If replacing a tube failed to clear up the trouble, he went on replacing tubes until he discovered those that were causing the set's outage. Chances are he'd charge for the one or two that had to be replaced to make the set work, but very often he'd forget the other new ones he'd stuck in the set's sockets. Consequently, lost tubes—and money. The

new cartons we'd supplied to our technicians often came back holding the customers' good-but-old tubes, which we could not sell as new replacements.

Under our strict control, every new tube carton must contain a new tube—or be empty. If it contains a new tube, OK. If it contains an old one, the technician pays for it before he gets a replacement to refill his kit.—Stanley Clark

Plug-in Electrolytics

Experimenters will find it convenient when building breadboard circuits to have "plug-in" electrolytics. They save much time and polarity troubles as



well as prolong the life of the component's terminals. Just solder each capacitor to an old bakelite tube base and plug this into a socket on the breadboard chassis.—Charles A. Cunningham

Odd-shaped Speaker Holes

Scribing a cutting line for elliptical speakers is next to impossible by ordi-

FREE Catalog

OF THE WORLD'S FINEST
ELECTRONIC GOV'T
SURPLUS BARGAINS



HUNDREDS OF TOP QUALITY ITEMS— Receivers, Transmitters, Microphones, Inverters, Power Supplies, Meters, Phones, Antennas, Indicators, Filters, Transformers, Amplifiers, Headsets, Converters, Control Boxes, Dynamotors, Test Equipment, Motors, Blowers, Cable, Kevers, Chokes, Handsets, Switches, etc., etc. Send for Free Catalog—Dept. RE.

FAIR RADIO SALES
2133 ELIDA RD. • Box 1105 • LIMA, OHIO

SAVE! Arrow's T-25 Staple Gun

Saves You Time and Money!

For Wire Up to 1/4" in Diameter . . . Bell, Thermostat, Radiant Heat, Telephone, Inter-com, Burglar Alarm, etc.

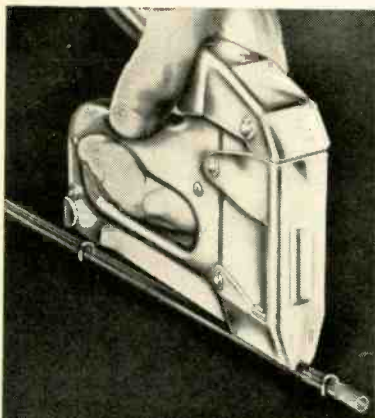

SAFE!

Can't damage wire because staples automatically stop at right height! Won't even break 1/4" hollow glass tubing.

FAST!

Proved by test 10 times faster than old hammer method. Saves you 70% in fatigue and efficiency . . . saves many dollars a year.

HOLDS!

New staples get tremendous holding power from tack points that spread to lock themselves into wood!

Tapered striking edge gets into tight corners!

T-25 AUTOMATIC STAPLE GUN for wires up to 1/4" in diameter. Uses 9/32", "3/8", 7/16", 9/16" round crown staples, galalloy coated for high rust resistance. LIST \$15.

Write for catalog and information.

ARROW FASTENER COMPANY, INC.

One Junius Street • Brooklyn 12, N. Y.

Superior's New Model 820

TUBE TESTER

TESTS ALL MODERN TUBES
INCLUDING THE NEW

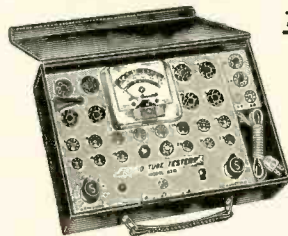

- ✓ NOVARS
- ✓ NUVISTORS
- ✓ 10 PINS
- ✓ 12 PIN COMPACTRONS

- Employs new improved emission circuit.
- Tests over 850 tube types.
- Tests OZ4 and other gas filled tubes.
- Employs new 4" meter with sealed air-damping chamber resulting in accurate vibrationless readings.
- Use of 26 sockets permits testing all popular tube types.
- Dual Scale meter permits testing of low current tubes.
- 7 and 9 pin straighteners mounted on panel.
- All sections of multi-element tubes tested simultaneously.
- Ultra-sensitive leakage test circuit will indicate leakage up to 5 megohms.

Model 820 comes complete with tube charts and instructions; housed in handsome, portable, Saddle-Stitched Texon case. Only **\$38.50**

SHIPPED ON APPROVAL
NO MONEY WITH ORDER — NO C. O. D.

Try it for 15 days before you buy. If completely satisfied then send \$5.00 and pay balance at rate of \$5.00 per month until total price of \$38.50 (plus postage) is paid — No Interest or Finance Charges Added! If not completely satisfied, return to us, no explanation necessary.

MOSS ELECTRONIC, INC.
DEPT. D-955, 3949 Tenth Ave., New York 34, N.Y.
Please rush Model 820. If satisfactory, I will pay on terms specified. Otherwise I will return tester.

Name _____
Address _____
City _____ Zone _____ State _____
All prices net, F.O.B. N.Y.C.

nary means. Try this: slice off the upper layer of the laminated cardboard gasket cemented to the outer rim of almost all inexpensive speakers. This leaves you with a semi-rigid ring that you can stick or tack to the baffle-board-to-be. Run a pencil or awl around the inside of the ring and you have your guide line. If you wish, you can cement the ring slice back onto the speaker when you're done. A pencil mark on the slice and speaker frame, made before you cut the ring, will help you get the thing back the same way.—C. C. Dodds

Top Hat in a Fuse Clip

The "top hat" type of silicon rectifier is generally soldered into the circuit. Those who wish to use a "top hat" to replace the cartridge kind or would like the ease of the plug-in type can use this innovation.

Take an old fuse (or a new one) and break off the metal ends. Solder this metal end to the negative end of the rectifier and clip the lead flush with

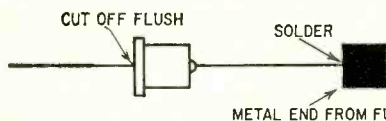

the positive end. If you are careful of the length of the negative end of the top hat and cut it to size, the silicon rectifier will plug right into the fuse holder.—Don Dudley

Kill SW on Old Sets?

Many prewar and early postwar radios were equipped with shortwave bands. In most cases the set is not very efficient on these bands since they were just tacked on as a sales feature. Sometimes such a set will come in for service with a broadcast reception complaint which is traced to the bandswitch. Before you repair or replace the switch, ask the customer if he's interested in shortwave reception. Most of the time, he won't be. Then you can simplify the service job by eliminating the bandswitch and wiring the set permanently for broadcast reception.—Charles Erwin Cohn

Pencil-Iron "Launching Pad"

Screw-fasten a rubber furniture leg tip to a block of wood and use this launching-pad type holder for your soldering pencil. With the pencil in the holder, you can do a three-handed job

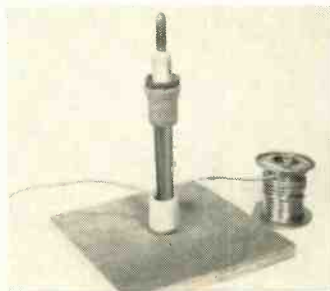

APRIL, 1963

Read Gernsback Library Books on Transistors

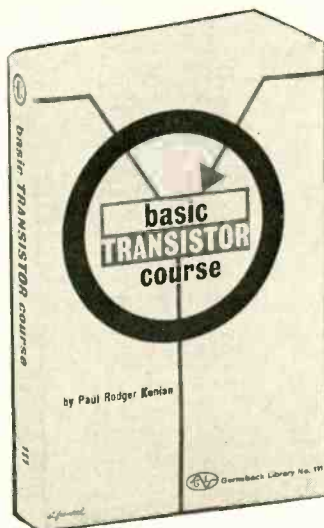

NEW!

Basic Transistor Course—Teaches transistor fundamentals clearly, simply. Discusses transistors all the way from elementary circuits to radio receivers. #111—\$4.10



How to Fix Transistor Radios & Printed Circuits—Two-volume set. Completely practical approach. How to service every section of receivers, including auto radios. Explains servicing methods, alignment, tests. #96—\$5.90 the set.

Transistors—How to test transistors and build all-transistor equipment, all bench-tested. #94—\$1.95

Transistor Projects—Build pocket radios, test equipment, all kinds of electronic gadgets. Each one pre-tested. Solid how-to-do-it construction details. #89—\$2.90

Servicing Transistor Radios—Covers theory, analysis of a typical set, techniques. Inside tips and warns about pitfalls. Useful charts for speed servicing. #78—\$2.90

Transistors—Theory & Practice—Covers theory, characteristics, use in well known circuits. A guide for students; a reference for technicians. #75—\$2.95

Transistor Circuits—Hundreds of useful and interesting transistor circuits. Invaluable for the experimenter, do-it-yourselfer. #63—\$2.75

Transistor Techniques—Keeps theory and math to a minimum and gives scores of hints on how to use transistors to best advantage. #61—\$1.50

Buy Now From Your Electronics Parts Distributor

Or, Use the Coupon Below

Gernsback Library, Inc., 154 West 14th Street, New York 11, N. Y.

111 78 REMITTANCE MUST ACCOMPANY ORDER
 96 75 Name _____
 94 63 Address _____
 89 61 City _____ Zone _____ State _____

Enclosed is \$ _____

43RE

FREE BOOK

"How to Interpret Oscilloscope Specifications"

JUST OFF THE PRESS. 12-page booklet tells you what specifications are of greatest importance. Shows how to determine desirability of any scope for servicing work on radios, black and white TV, color TV. A valuable reference for Technicians and Engineers. For your copy cut out this ad, write your name and address in margin and mail to CONAR KITS, Dept. DC3CA, 3939 Wisconsin Ave., Washington 16, D.C.

GIVE

AMERICAN CANCER SOCIETY

easily with only the normal two hands. Used as a pencil rest when the iron is idle, heat from the tip rises upward and the handle stays cool.—*Joe C. Allan*

Battery-Polarity Reminders

The small printed polarity markings on most dry batteries are easily misread. Since reversed connections often destroy expensive transistors, it pays to attach larger and more readable



labels. Inexpensive pressure-sensitive labels are available at any stationery store. Mark them with bold plus and minus signs, using an instant-drying marker pen. Press the finished label into place alongside the appropriate battery terminal.—*William E. Bentley*

Record-Changer Work Stand

You can easily build this repair stand with just three large shelf brackets and a piece of plywood.

Mount the brackets on the ply-



wood as shown. Use just one wood screw in the end hole of each. This allows the brackets to swing around,



thus adjusting to fit just about any changer you have to work on.

Materials needed:

- 3—Large shelf brackets
- 3— $\frac{3}{4}$ inch No. 10 filister-head wood screws
- 1—2 x 2-foot piece of $\frac{3}{4}$ -inch plywood.—*Wayne Lemons* END

1 YR. GUARANTEED

Mutual Conductance Lab-tested, Individually Boxed, Branded and Code Dated

RADIO & TV TUBES

CORNELL

33¢

PER TUBE

100 TUBES OR MORE:
30¢ PER TUBE

Type	Type	Type	Type	Type	Type
OZ4	6AU4	6CG7	6Q7	7A7	12BF6
1B3	6AU5	6CG8	65A	7B6	12BH7
1L4	6AU6	6CM7	6SA7	788	12BL6
1T4	6AU8	6CX8	6SC7	7C5	12BQ6
1U4	6AV6	6CZ5	6SH7	7Y4	12BY7
1X2	6AW8	6D6	6SJ7	12AD6	12C5
2A5	6AX4	6DA4	6SK7	12AE6	12CA5
3CB6	6BA6				12DQ6
3Q5	6BC5				12SN7
5U4	6BD6				12SQ7
5V4	6BG6				25L6
5Y3	6BM6				25Z6
5Z3	6BJ6				35W4
6A6	6BL7				35Y4
6A8	6BN4				35Z5
6AB4	6BN6	6DE6	6SL7	12AF6	50L6
6AC7	6BQ6	6DQ6	6SN7	12AT7	117Z6
6AG5	6BQ7	6F6	6SQ7	12AU7	27
6AL5	6BX7	6H6	6U8	12AX4	41
6AN8	6BZ6	6J5	6V6	12AX7	45
6AQ5	6C4	6J6	6W4	12B4	47
6AS5	6CB6	6K6	6W6	12BA6	75
6AT6	6CD6	6K7	6X4	12BD6	80
6AT8	6CF6	6L6	6X5	12BE6	84/6Z4

If not shipped
in 24 hrs.
YOUR ORDER
FREE!

NO SUBSTITUTIONS WITHOUT YOUR PERMISSION!!
Other tube types available at low prices.
Send for Free Tube List.

Tubes are new, seconds or used and so marked.

TERMS: All Pre-Paid Orders over \$5.00 postage free. Under \$5.00 add 50¢ for handling. Send 25% Deposit on all CDD orders. Canadian and Foreign orders, send approximate postage. All orders subject to prior sale. 5-DAY MONEY BACK OFFER!

SPECIAL!
With every \$10 Order

25¢

per tube (No Limit) from this list.

6AG5 6CG7 6SN7

6AL5 6J6 6V6

6AU6 6K6 6W4

CORNELL ELECTRONICS CO.

RE-4 4217 University Ave., San Diego 5, Calif. • Phone: AT 1-9792

I E E E

HEAR

DISTINGUISHED SPEAKERS & PANELISTS

at

I-TRIPLE-E's

International Convention
and Exhibition in New York

MARCH 25, 26, 27, 28

The COLISEUM at Columbus Circle
& The WALDORF ASTORIA HOTEL

admission: MEMBERS \$1.00; NON-MEMBERS \$3.00
MINIMUM AGE: 18

SHOW

(formerly the IRE Show)

new PATENTS

ARC LAMP

PATENT NO. 2,972,698

Leo I. Dana, Larchmont, N.Y. and Harold S. Morton, Jr., Gaithersburg, Md., (Assigned to Union Carbide Corp.)

The tungsten cathode is inside a water-cooled nozzle. The copper enclosure serves as the anode. The arc operates under high gas pressure, prefera-

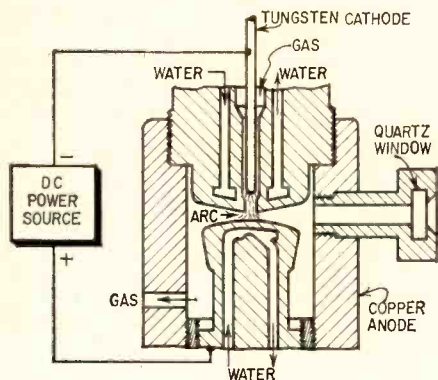

bly xenon at 25 atmospheres approximately. The gas stabilizes the arc and makes it uniform. The light intensity may be as high as 120,000 candle-power per sq cm, with a power source of 100 amps at 38 volts. This light source is suitable for motion-picture projection.

Sound-Powered Radio

PATENT NO. 2,981,833

George W. Bryan, Jr., Wall Township, N. J. (May be used by US Government without payment of royalties)

The output of a sound-powered telephone is only a few milliwatts, but it is sufficient to energize a radio transmitter. The audio is first stepped up

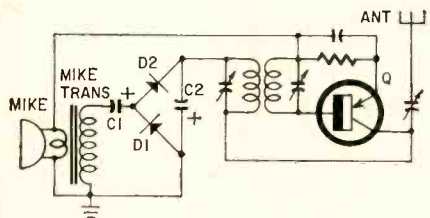

about 10 times, then fed to a voltage doubler comprising C1, C2, D1, D2, to power oscillator Q.

The audio signal is in series with the emitter, so it modulates the rf carrier. The range of this transmitter approaches line-of-sight in the 30-mc region.

Flash-Tube Circuit Regulator

PATENT NO. 2,983,850

Harold E. Edgerton, Belmont, Mass. (Assigned to Edgerton, Germeshausen & Grier, Inc., Boston)

A resistor in series with an electrolytic capacitor regulates this electronic flash-tube circuit.

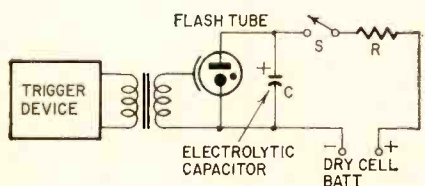

The leakage current through an electrolytic capacitor increases considerably near its rated volt-

age. This leakage current flows through R, producing a drop which prevents overloading the lamp. As the battery ages, the capacitor voltage begins to fall. Therefore the leakage is lowered, as is the drop across R. This permits more of the battery voltage to reach the tube.

Although a higher initial battery voltage is needed, the battery's useful life is greatly extended.

Tape Recorder Oscillator

PATENT NO. 2,980,768

Robert J. Ehret, Los Altos, Calif. (Assigned to Ampex Corp., Redwood City, Calif.)

Here a pair of transistors supplies ac bias and erase current for tape recorders. The circuit configuration is a complementary-symmetry Colpitts

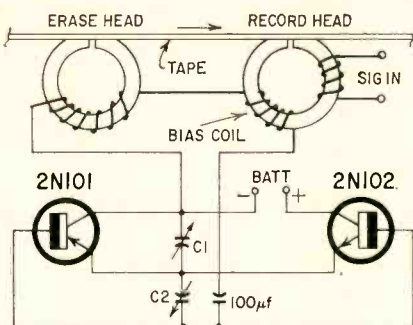

oscillator, using the bias and erase coils in series as tank inductances. These, together with C1 and C2, determine the operating frequency, which may lie anywhere between 4 and 80 kc.

The inventor claims high efficiency for his circuit, because there are no resistors to dissipate power.

Expander

PATENT NO. 2,986,708

Farrell A. Buckley, Manhattan Beach, Calif. (Assigned to Hughes Aircraft Co., Culver City, Calif.)

The output of this cathode follower increases faster than its input, which is a positive signal. Initially, with no signal, both diodes are back-biased due to negative voltages at their anodes.

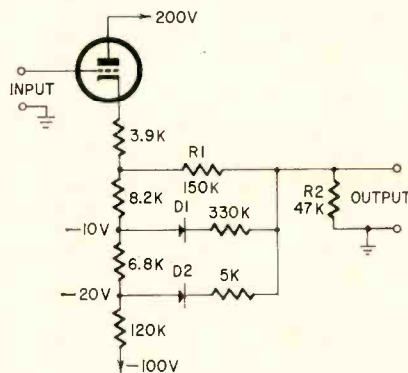

Current flows through the load, R2, when the grid goes positive. At some definite value the drop across R1 will overcome D1's bias. Conduction opens a second path for the cathode current and increases the output. With an even greater grid signal, D2 conducts also. At this time nearly the entire cathode output will appear across R2.

Diode conduction does not change abruptly, so the expansion effect is gradual throughout the range.

HIGH FIDELITY SYSTEMS — A User's Guide by Roy F. Allison

AR Library Vol. 1 70 pp., illus., paper \$1.00

This is a layman's practical guide to high fidelity installation. We think that it will become a classic work for novices (and perhaps be consulted secretly by professionals). Norman Eisenberg writes in *High Fidelity*: "... welcome addition to the small but growing body of serious literature on home music systems . . . Allison addresses himself with clarity and intelligence to the rank novice." From Jack Grubel's review in the *Bergen Evening Record*: "... completely basic . . . If this doesn't give you a road-map into the field of hi-fi, nothing will."



REPRODUCTION OF SOUND

by Edgar Villchur

AR Library Vol. 2 93 pp., illus., paper \$2.00

Vol. 2 explains how components work rather than how to use them, but it presupposes no technical or mathematical background. Hans Fantel says in *HiFi/Stereo Review*: "... just the book to satisfy that intellectual itch for deeper understanding . . . Villchur has his material so tightly organized and writes about it with such lucid economy of words that even the more technical aspects of audio become intelligible . . ." Martin Mayer writes in *Esquire*: "... far and away the best introduction to the subject ever written — literate, intelligent and, of course, immensely knowledgeable."



AR Needle Force Gauge \$1.00

The same gauge that is supplied with AR turntables. It is an equal arm balance with weights to 1/4 gram, accurate enough to be used at the AR plant ($\pm 5\%$), and complete with instructions and case.



ACOUSTIC RESEARCH, INC.
24 Thorndike St., Cambridge 41, Mass.

Please send me the following:

- Roy Allison's "High Fidelity Systems — A User's Guide" at \$1
- Edgar Villchur's "Reproduction of Sound" at \$2
- AR needle force gauge at \$1

I enclose \$_____ in bills, money order, or check only. (All prices postpaid.)

NAME _____

ADDRESS _____

NEW 1963 TWO WAY RADIO 5 TRANSISTOR TRANSCEIVER

CITIZENS BAND

Hams, Hunters, Rangers, Construction, Farmers, Boating, Sportsmen. It's a genuine rugged 5 transistor factory-wired walkie-talkie at a pleasantly low price. Has sensitive super-regenerative receiver and crystal-controlled transmitter with maximum legal power citizens band transceivers, built in 2 1/2" speaker. Removable whip antenna, 5 sections, extends to 30". Attractive durable steel case 6 x 2 3/4 x 1 1/4". Compact hand held unit. Fully guaranteed. Shipping weight 15 oz. Mfg. in U.S.A.



Specially Priced at \$13.50 Ea.

With 9V Battery, plus 75 cents for shipping and handling

WARREN ELECTRONICS CO.
89 Chambers St., Dept. A, New York 7, N.Y. WO 2-5727
No C.O.D. Send Check or Money Order

SILICON TOP HATS OR DIODES



750 MA
LOWEST PRICES
GUARANTEED

LOW LEAKAGE NEWEST TYPE

PIV/RMS	PIV/RMS	PIV/RMS	PIV/RMS
50/35 .05 ea.	100/70 .09 ea.	200/140 .12 ea.	300/210 .18 ea.
400/280 .23 ea.	500/350 .28 ea.	600/420 .38 ea.	700/490 .50 ea.
800/560 .58 ea.	900/630 .68 ea.	1000/700 .78 ea.	1100/770 .88 ea.

ALL TESTS! AC & DC FVD!

ALSO TESTED ON LOAD

100 Dif. Pre. Res. 1/2, 1, 2 WATT—1% Tol. \$1.25
G.E. IN91 Diode—10 for \$1.00, 100 for \$8.00
Special 8 Amp. 400 V Sil. Stud Rect. 10 for \$9.50

SILICON POWER DIODE STUDS

Amps	Piv	Sale	Amps	Piv	Sale
3	50	50.15	35	50	\$1.30
3	100	.30	35	100	1.55
3	200	.40	35	200	2.00
3	400	.65	35	400	3.00
3	600	.75	50	50	2.25
12	50	.60	50	100	3.25
12	100	.80	50	200	4.00
12	200	1.00	100	50	2.75
12	400	1.50	100	100	3.50
12	600	2.00	100	300	4.90

All material guaranteed. \$2.00 min. order. Orders F.O.B. NYC. Include check or money order. Snpq. charges plus. C.O.D. orders 25¢ down.

WARREN ELECTRONICS CO.

NYC 7, NY 87 Chambers St. WO 2-5727



The more will live
the more you give
to the HEART FUND

CONVERT TO COLOR TV

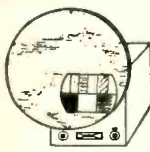

COLORDAPTOR—A simple 10-tube circuit and rotating color wheel converts any size B & W TV to receive compatible color.

COLORDAPTOR — Easily attached to any TV set, does not affect normal operation, often built from parts experimenters have on hand, **BRILLIANT COLOR!**

Complete booklet—gives theory of operation, all construction details, schematic, and sample color filters. **\$195**

Essential Parts Kit—Includes all special parts—coils, delay line, crystal, color filters. Add \$1.00 for sets over 16". **\$19.95**

COLORDAPTOR 1798 Santa Cruz, Menlo Park, Calif.

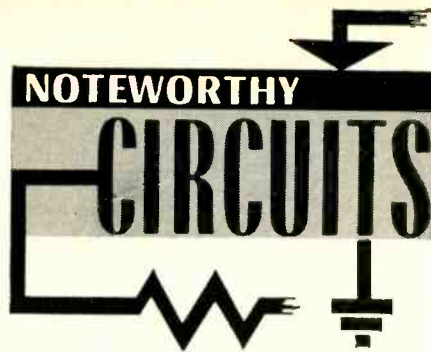

Receiver Disabling Switch

This little T-R switch is ideal for amateur, mobile and marine use and in installations where the receiver operates from a separate antenna close to the transmitting antenna. It protects the receiver against overloading and prevents high rf voltages from damaging its antenna transformer. Fully automatic, the device makes it unnecessary to connect

tor diodes D1 and D2. When the transmitter is keyed, the diodes conduct and develop a negative bias on V1's base. V1 conducts and develops a negative voltage across R3. This turns on V2, pulling in the relay so it shunts the transmission line with R1 and grounds the receiver's antenna terminal. R1 should match the transmission line impedance.

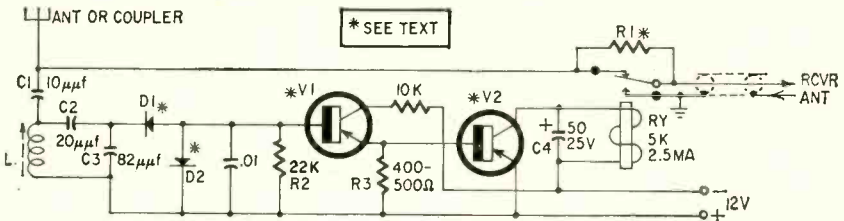

the set's antenna through a relay tied into the transmitter's keying circuit.

Inexpensive general-purpose p-n-p transistors and diodes such as the 2N-107, CK-722, 2N1191, 1N34, 1N46 and 1N51 can be used. With the constants shown, the relay pulls in when the applied rf reaches about 1.1 volts rms.

Rf from the antenna or transmission line is fed through C1 to tank circuit L-C2-C3 tuned to the transmitter's frequency. C2 and C3 form a capacitive voltage divider feeding detec-

If you operate CW, select C4 to match your average transmitting speed and desired break-in characteristics.

The circuit can be modified to operate on lower antenna voltages by changing the ratios of C2-C3 and R2-R3. R2 can be eliminated and R3 raised to around 5,000 ohms. If the unit is installed in a spot where temperature is high reduce R2 to 10,000 ohms. This reduces sensitivity so you must compensate by adjusting the values of C2 and C3.—Keith C. Morton, WINDH

Rf Q Multiplier

Does your short-wave receiver need more gain? You can obtain it by constructing and connecting a simple regenerative stage tuned to the desired rf band. Simply connect the regenerator to the antenna that feeds the receiver and adjust the regenerator for optimum. The regenerator multiplies the Q of the set's input circuit. Therefore, it increases circuit gain. The improvement in selectivity is not noticeable because the operating frequency is high.

Fig. 1 shows a typical regenerator

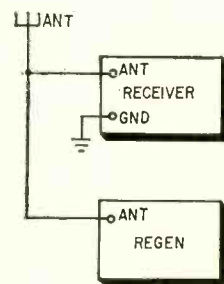
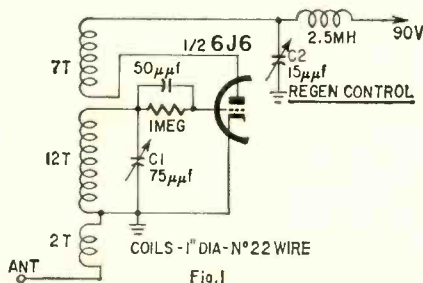

Fig.2

for approximately 7 to 16 mc. It is connected as shown in Fig. 2. Tune C1 to the desired frequency and set C2 just below oscillation. Coils are wound on a 1-inch form, and each winding is about 1/16 inch from the next.

You will be amazed at the results. An S1 signal will come up to S7 or more with optimum adjustment of the regenerator. Of course, if your receiver already has high gain and goes down to the noise level, this setup cannot help

you. As with any amplifier (including the maser) the noise will come up along with signal.—*I. Queen*

Neon Baffler

Here is a simple circuit in which a neon lamp is controlled by a 1½-volt battery. We know that a transformer does not pass dc, but the behavior of this circuit might give the impression that it does. When switch S is closed, the lamp lights and stays on as long as S is held closed. When the switch is opened, the lamp goes out. (The polarity of BATT 1 and the transformer connections are critical—this action is not obtained when BATT 1 is reversed or transformer leads transposed.)

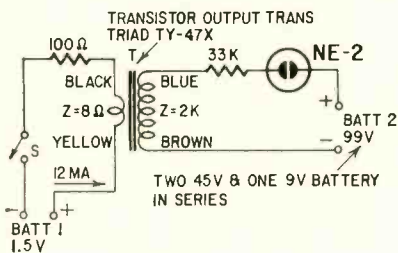

What is the explanation? BATT 2's voltage is too low to fire the lamp. When S is closed, the sudden start of the primary current induces a momentary secondary voltage in the transformer, and this voltage adds to BATT 2 and fires the lamp. By nature, the neon lamp, once fired, will remain on until its circuit is opened; the steady primary current (12 ma) has nothing to do with it. However, when switch S is opened, the sudden cessation of primary current induces a back voltage across the secondary. This voltage bucks BATT 2, reduces the lamp voltage momentarily, and extinguishes the lamp.—*Rufus P. Turner* END



"He says he was trying to pull a car radio."

APRIL, 1963

SCOTT STEREO TUNER KIT WINS RAVE REVIEWS



"The LT-110 met all the manufacturer's detailed specifications on sensitivity, distortion, output level, a.c. hum, and capture ratio. . . the audio response is excellent, being within ± 1 db, from approximately 20 to 16,000 cycles. . . Channel-to-channel crosstalk is particularly excellent both in terms of uniformity and the fact that it holds up."

Popular Electronics, Oct. 1962

"The LT-110 (is) so simple to build that we unhesitatingly recommend it for even the novice. . . We found that the usable sensitivity (IHF_M) was 2.1 μ v. . . a fine stereo tuner and an unusually easy kit to build."

Audio, April 1962

"It seems to me that every time I turn around I am building another of H. H. Scott's kits. And each time I end up praising the unit to the skies."

American Record Guide, Sept. 1962

Now Sonic Monitor* Added

LT-110 \$159.95 (slightly higher West of Rockies). *Patent Pending



NEW KIT CATALOG . . . JUST OFF THE PRESS!

H. H. Scott, Inc., 111 Powdermill Road, Maynard, Mass. Rush me your new kit catalog, your new "Guide to Stereo". Dept. 570-4

Name.....
Address.....

City..... State.....

Include name and address of interested friend and we'll send him these helpful Scott aids.

Export: Morhan Exporting Corp., 458 Broadway, N.Y.C.
Canada: Atlas Radio Corp., 50 Wingold Ave., Toronto



TOO HIGH?

Mail us your list of components for a Price-Crushing quote on your stereo hi-fi needs!

Write too for our valuable audio discount catalog A-17.

KEY ELECTRONICS CO.
120 Liberty St. New York 6, N. Y.

GM PHOTOELECTRONICS
623 So. Gay Street Knoxville 2, Tenn.

AMPLIFIERS

Stereo 14W. \$29.95. Radio-TV-Components FREE CATALOG

ELECTRONICS

Engineering-Technicians

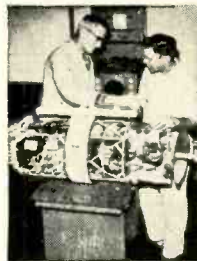

Heald's Microwave and Radar Laboratory Equipment.

The Nation's increased demand for Engineers, Electronic Technicians, Radio TV Technicians is at an all time high. Heald Graduates are in demand for Preferred High Paying Salaries. Train Now for a lucrative, satisfying lifetime career.

Bachelor of Science Degree, 30 Months
Save Two Years' Time

- Radio-Television Plus Color Technician (12 Months)
- Electronics Engineering Technology (15 Months)
- Electronics Engineering (B.S. Degree)
 - Electrical Engineering (B.S. Degree)
 - Mechanical Engineering (B.S. Degree)
 - Civil Engineering (B.S. Degree)
 - Architecture (B.S. Degree)

Approved for Veterans DAY AND EVENING CLASSES

Write for Catalog and Registration Application. New Term Starting Soon.

HEALD'S ENGINEERING COLLEGE

Established 1863

Van Ness at Post, RE
San Francisco, Calif.

Your Name.....
Address.....
City.....
State.....

"TAB" FOR TRANSISTORS & DIODES!!!

Full Leads Factory Tested & Gtd! U.S.A. Mfg.
 PNP 50Watt 15Amp Hi Power T036 Pkg. 2N441, 442, 277, 278, DS501 up to 50 volts VC80 1 @. 12 for \$10
 2N278, 443, 174 up to 80V/VC80 \$3 @. 4 for \$10
 PN 10Watt 3A-2N155, 156, 239, 242, 254, 255, 256, 257, 301, 351 ea. c45 @. 5 for \$2
 PNP 2N107, 123, 218, 223, 119A, 1265, GT222, TR722 & CK722 c25 @. 5 for \$1
 NPN 2N55, 94, 194, 213, 214, 256, 228, 233, 292, 293, 306, 516, 517, 1101 c35 @. 3 for \$1, 100 for \$30
 PNP 2N670 300M c50 @. 10 for \$4, 100 for \$35
 PNP 2N671 1Watt c75 @. 10 for \$6, 100 for \$50
 Silicon PNP/T05 & T018 Pkg 2N327A, 332to8 2N474 to 9, 480, 541 to 3, 935 to 7 & 1276 to 9 c59 @. 8 for \$4, 25 for \$10
 Round or Diamond Base Mica Mid Kit c30 @.
 Power Heat Sink Fins 80 Sq \$1.39
 Kit Glass Diodes equiv. 1N34A, 40 48, 51, 12 for \$1, 100 for \$6, 1000 for \$50

Kit Zener Diodes up to 400mw.....3 for \$1
 Kit Stabilator Diodes up to 1 Watt.....4 for \$1
 Kit Photo Sun Cells Assort Sizes.....4 for \$1
 Weston Std Voltaic Cell \$4 @. 3/\$10

Silicon Power Diode Studs

D.C. Amps	50Piv 35Rms	100Piv 70Rms	150Piv 105Rms	200Piv 140Rms
3	.25	.35	.45	.55
12	.70	.95	1.20	1.45
35	1.40	1.85	2.15	2.50
100	2.90	3.60	3.80	4.15
240	4.50	5.70	6.90	8.40

D.C. Amps	300Piv 210Rms	400Piv 280Rms	500Piv 350Rms	600Piv 420Rms
3	.70	.85	1.20	1.40
12	1.65	1.90	2.70	3.69
35	2.90	3.90	5.20	5.60
100	5.50	7.50	10.00	11.00
240	16.50	24.50	32.50	36.50

Send for Data Write for Quantity
 Export & O.E.M. Prices

GTD! Octal Silicon-SU4C-Tube Replacement
 1120ms 1600Piv \$4 @. 2 for \$6; 4 for \$10
 5R4 Silicon 1900/2800Piv \$4
 866A Silicon 5000/10400Piv \$9
 024 Silicon \$1.50 @. 4 for \$5

"TAB", SILICON 750MA* DIODES Factory Tested! Gtd. I
***NEWEST TYPE! LOW LEAKAGE!**

Piv/Rms	50Piv/35Rms	100Piv/70Rms	150Piv/105Rms	200Piv/140Rms
.05 ea.	.10 ea.	.14 ea.	.20 ea.	.25 ea.
Piv/Rms	400/280	500/350	600/420	700/490
.25 ea.	.30 ea.	.40 ea.	.52 ea.	.60 ea.
Piv/Rms	800/560	900/630	1000/700	1100/770
.60 ea.	.70 ea.	.80 ea.	.90 ea.	1.00 ea.

All Tests! AC & DC & FWD! & Load!

D.C. POWER SUPPLY 115V/60to800CvK Inhd.
 330u165VDC up to 150MA. CASED! SPECIAL \$5

"TAB" TERMS: Money Back Guarantee!
 Our 18th Year. \$2 Min. order
 F.O.B. N.Y.C. Add shpg charges
 or for C.O.D. 25% Dep. Prices
 shown subject to change.
 111-RD Liberty St., N.Y. 6, N.Y.
 Phone: REctor 2-6245 for Catalog



HAVING FUN WITH TRANSISTORS, by Len Buckwalter. Howard W. Sams & Co. Inc., 1720 E. 38 St., Indianapolis 6, Ind. 5 1/2 x 8 1/2 in., paper. 127 pp. \$2.50.

A number of simple and interesting electronic projects, including items like a home broadcaster and a musical oatmeal box. All projects are clearly described and illustrated with pictorial diagrams.

ELECTRONIC, RADIO AND MICROWAVE PHYSICS, by D. E. Clark and H. J. Mead. MacMillan Co., Fifth Ave., New York 11, N.Y. 6 x 9 1/4 in., 521 pp. Cloth, \$25.

A detailed reference book with a mathematical approach for college seniors and engineers.

MODERN COMMUNICATIONS COURSE (Vol. 1), by Edward M. Noll. Howard W. Sams & Co. Inc., 1720 E. 38 St., Indianapolis 6, Ind. 5 1/2 x 8 1/2 in. 256 pp. \$4.95 paper.

A self-study course plus experimental projects covering rf amplifiers, oscillators, antennas and measurements.

HI-FI HANDBOOK (second revised edition), by Steven Hahn. Thomas Y. Crowell Co., 201 Park Ave. So., New York 3, N.Y. 5 1/2 x 8 in., 216 pp. Cloth, \$4.95.

This illustrated guide is intended to help you select your tuner, recorder, changer or amplifier.

SERVICING ELECTRONIC ORGANS, by Carl R. Pittman and Eugene J. Oliver. Howard W. Sams & Co. Inc., 1720 E. 38 St., Indianapolis 6, Ind. 5 1/2 x 8 1/2 in. 191 pp. \$4.95 paper.

The theory and data that radio technicians need to understand, tune and repair these instruments. Typical commercial types are discussed.

INDUSTRIAL CONTROL ELECTRONICS, by Matthew Mandl. Prentice-Hall Inc., Englewood Cliffs, N. J. 6 x 9 in. 344 pp. Cloth, \$10.65.

A basic introduction of the fundamental principles and practices of modern electronic control circuits.

HOW TO AVOID LAWSUITS IN TV, RADIO, APPLIANCE SALES AND SERVICE, by Leo T. Parker. John F. Rider, Publisher Inc., 116 W. 14 St., New York, N. Y. 5 1/2 x 8 1/2 in. 72 pp. Paper, \$1.

A brief but detailed technician's guide that could have been titled "How To Stay Out Of Court".

FUNDAMENTALS OF ACOUSTICS, 2nd ed., by Lawrence E. Kinsler and Austin R. Frey. John Wiley & Sons, Inc., 440 Park Ave. South, New York 16, N.Y. 6 x 9 in., 524 pp. Cloth, \$10.75.

A concise survey of basic theory and modern applications, for graduate classrooms as well as home study.

BUILDING UP YOUR HAM STATION, by Howard S. Pyle, W7OE. Howard W. Sams & Co., Inc., 1720 E. 38th St., Indianapolis, Ind. 5 1/2 x 8 1/2 in. 128 pp. \$2.50.

A valuable aid to the new ham selecting equipment for a basic ham station that can be upgraded with minimum expense. Includes information on new, used, kit and (Continued on page 105)

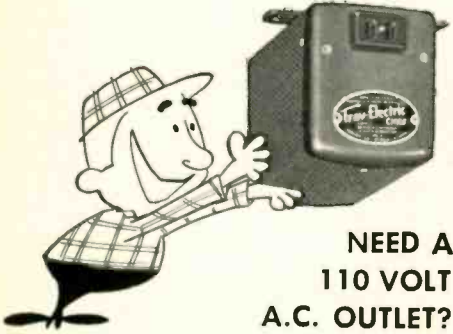

NEED A 110 VOLT A.C. OUTLET? IN CAR, BOAT or TRUCK, YOU HAVE IT WITH A

terado POWER INVERTER

Actually gives you 110 volt, 60 cycle A.C. from your 6 or 12 volt D.C. battery! Plug inverter into cigarette lighter, and operate lights, electric shavers, record players, electric tools, portable TV, radios, testing equipment, etc. Frequency will not change with change in load or input voltage.

Models from 15 to 300 watts, priced as low as **\$12.95** LIST

See Your Electronic Parts Jobber, or Write:
terado CORPORATION
 1055 Raymond Ave.
 St. Paul 8, Minn.
 In Canada. ATLAS RADIO CORP. LTD. - Toronto, Ont.

IEEE SPEAK
 TO OUTSTANDING
 ELECTRONICS ENGINEERS,
 SCIENTISTS, PHYSICISTS
 at
I-TRIPLE-E's
 International Convention
 and Exhibition in New York
MARCH 25, 26, 27, 28
 The COLISEUM at Columbus Circle
 & The WALDORF ASTORIA HOTEL
 admission: MEMBERS \$1.00; NON-MEMBERS \$3.00
 MINIMUM AGE: 18
SHOW
 (formerly the IRE Show)

Special Low-Cost SUBSCRIPTION RATES to RADIO-ELECTRONICS
 available to clubs, associations and other groups.
 Write G. Aliquo Radio-Electronics 154 W. 14 St. New York, N.Y.

SCHOOL DIRECTORY

ENGINEERING EDUCATION
for the Space Age

NORTHROP INSTITUTE of Technology is a privately endowed, nonprofit college of engineering offering a complete Bachelor of Science Degree Program and TWO-YEAR accredited technical institute curricula. Students from 50 states, many foreign countries. Outstanding successful graduates employed in aeronautics, electronics, and space technology. Write today for catalog—no obligation.

NORTHROP INSTITUTE OF TECHNOLOGY
1181 West Arbor Vitae Street, Inglewood 1, California

ENGINEERING B.S. DEGREE
SCIENCE IN 36 MOS.
MATH



U.S. NEEDS 50,000 NEW ENGINEERS A YEAR! EARN ACCREDITED B.S. DEGREE in Science or Engineering in 36 months—year-round program optional. 27-month engineering diploma also available. Classes start June, Sept., Jan., March. **QUALITY EDUCATION.** Graduates employed throughout the U. S. and abroad. Government approved for veteran training. Students from 50 states, 40 countries. 20 buildings: dorms, gym, Campus. New library and laboratories. Employment help provided. **SAVE TIME AND MONEY.** Write for catalog 1616 E. Washington Boulevard, Fort Wayne 2, Indiana

Indiana Institute of Technology
formerly Indiana Technical College

FREE CAREER BOOKLET

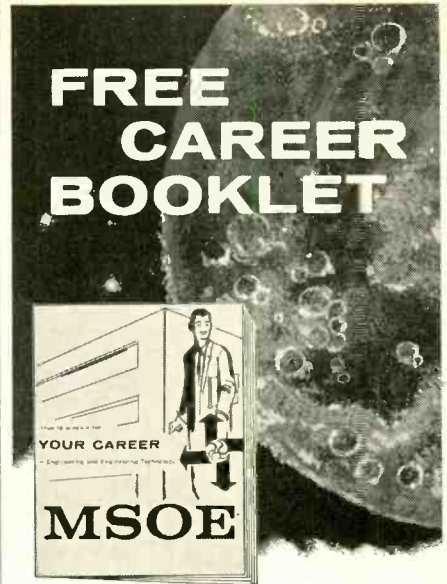

YOUR CAREER
Engineering and Engineering Technician

M.S.O.E.

ENGINEERING DEGREES

Electronics, Mechanical. Also in Liberal Arts (Major in Accounting) earned by

HOME STUDY
Resident Classes Also Available if Desired
Specify course preferred

PACIFIC INTERNATIONAL COLLEGE OF ARTS & SCIENCES
Primarily a correspondence school
Chartered 1935

5719-M Santa Monica Blvd. Hollywood 38, Calif.

engineering degree in 27 months

Become an Electronics Engineer. College graduates enjoy higher income... advancement. Major corporations visit us regularly to interview and employ seniors. **BACHELOR OF SCIENCE DEGREE IN 27 MONTHS** in Electrical (Electronics or Power major), Aeronautical, Chemical, Mechanical, Civil Engineering. **IN 36 MONTHS** a B.S. Degree in Business Administration. One-year Drafting-Design Certificate Program. Small classes. Well-equipped labs. Campus. Dorms. New library, *Moderate Costs.* Enter June, Sept., Jan., Mar. Founded 1884. Write **J. G. McCarthy** for Catalog and "Your Career in Engineering and Commerce" Book.

TRI-STATE COLLEGE
2443 College Avenue • Angola, Ind.

GET INTO ELECTRONICS

V.T.I. training leads to success as technicians, field engineers, specialists in communications, guided missiles, computers, radar and automation. Basic & advanced courses in theory & laboratory. Electronic Engineering Technology, an ECPD accredited Technical Institute curriculum. Assoc. degree in 29 mos. B.S. also obtainable. G.I. approved. Graduates in all branches of electronics with major companies. Start Feb., Sept. Dorms, campus. High school graduate or equivalent. Catalog.

VALPARAISO TECHNICAL INSTITUTE
Department C, Valparaiso, Indiana



CASH FOR YOU—REPAIR BUSTED

Electric APPLIANCES

Learn at Home • \$3 to \$5 an Hour
Spare Time, Full Time • Be Your Own Boss

FREE BOOK tells about profitable business you can run—right at home. Repair Electric Appliances, using simple tools. Pays \$3-\$5 an hour!

QUICK WAY TO GET STARTED
For less than 20¢ a day, our easy instruction—backed by 45 years of success in home-training—prepares you for top earnings. Earl Reid of Thompson, Ohio, says: "Made \$610 in one month spare time." At no extra charge you get Appliance Tester, too. Finds trouble-spots, checks your work.

Get your **FREE** Book and **FREE** Sample Lesson! Mail coupon below, letter or postcard, now.

NATIONAL RADIO INSTITUTE, Appliance Div.
Dept. FD3, Washington 16, D. C.

Send Free Book, Free Appliance Repair Course Lesson. Am interested in:

Spare Time Earnings My Own Business
 Better Job

Name _____
Address _____
City _____ Zone _____ State _____
Accredited Member National Home Study Council

ELECTRONICS IS HIGHER INCOME!

Prepare NOW! EARN YOUR A. S. DEGREE IN 24 MOS.

DEMAND FOR ELECTRONIC ENGINEERING TECHNOLOGISTS EXCEEDS SUPPLY! Enroll with a nationally-recognized leader in electronics education. ECPD Accredited Technical Institute curricula in Electronic Engineering Technology and Commercial Broadcast Technology. Complete career preparation for booming fields of **ELECTRONICS—COMMUNICATIONS—BROADCASTING—COMPUTER TECHNOLOGY—COMPUTER PROGRAMMING.** College level resident and home-study courses. Coeducational. Up-to-date laboratories feature IBM, BENDIX and UNIVAC electronic computers and data processing equipment. SEND COUPON FOR COMPLETE CATALOG.

CENTRAL TECHNICAL INSTITUTE 1644 Wyandotte, Kansas City 8, Mo. REO43

Name _____ Age _____
Address _____
City _____ Zone _____ State _____
CHECK INTEREST: Resident Home Study

Engineering Technician
A.S. Degree—2 Years
Electronics Engineer
B.S. Degree
Evening Courses Available

ELECTRONIC TECHNICAL INSTITUTE
970 W. Manchester Ave., Inglewood, Calif.
4863 El Cajon Blvd., San Diego, Calif.

GET IN ON THE GROUND FLOOR IN ELECTRONICS!

Demand for trained men in every phase of electronics and radio-TV has never been higher. And new opportunities are opening up so fast that you can still get in on the ground floor. But only if you act now.

To prove how I.C.S. can help you break into this big money-making field, we'd like to send you—**FREE**—the famous I.C.S. Electronic Career Kit. There are 3 valuable booklets in this kit—guaranteed to open your eyes to opportunity, and show you how easily you can take advantage of it! But don't delay. This could be your chance of a lifetime! Mail the coupon today.

INTERNATIONAL CORRESPONDENCE SCHOOLS

Dean's Office Z3753C, Scranton 15, Pa.
Please rush me **FREE** Career Kit. My field of interest is:

FCC Lic., TV-Radio Engr. Electrical Engr.
 Electronic Technician Electrical Technician
 Electronic Computers Practical Electrician
 Stereo and Hi Fi Profess'l Engrg. (Elec.)
 Automation Electronics Electrical Drafting
 TV-Radio Servicing Other _____

Name _____ Age _____
Address _____
City _____ Zone _____ State _____

to guide you to a successful future in

ELECTRONICS RADIO-TV COMPUTERS ELECTRICAL ENGINEERING

This interesting pictorial booklet tells you how you can prepare for a dynamic career as an Electrical Engineer or Engineering Technician in many exciting, growing fields:

MISSILES • RADAR • RESEARCH ELECTRICAL POWER • ROCKETRY AUTOMATION • AVIONICS SALES • DEVELOPMENT

Get all the facts about job opportunities, length of study, courses offered, degrees you can earn, scholarships, part-time work — as well as pictures of the Milwaukee School of Engineering's educational and recreational facilities. No obligation — it's yours free.

MILWAUKEE SCHOOL OF ENGINEERING

MAIL COUPON TODAY!

MILWAUKEE SCHOOL OF ENGINEERING
Dept. RE4-63, 1025 N. Milwaukee St.
Milwaukee, Wisconsin MS-113

Please send **FREE** "Your Career" booklet I'm interested in Electronics Radio-TV Computers Electrical Engineering Mechanical Engineering
(PLEASE PRINT)

Name _____ Age _____
Address _____
City _____ Zone _____ State _____
 I'm eligible for veterans education benefits.
Discharge date _____

R-E**Classified****ADS**

Rates—55¢ per word (including name, address and initials). Minimum ad 10 words. Payment must accompany all ads except those placed by accredited advertising agencies. Misleading or objectionable ads not accepted. Copy for June issue must reach us before April 10, 1963 **RADIO-ELECTRONICS**, 154 West 14 St., New York 11, N. Y.

SERVICES

ELECTRONIC MANUFACTURER, tax exempt, will make your product at substantial savings. Engineering and/or production facilities available. **MILLES ENGINEERING**, Las Marias, P.R.

METERS—MULTIMETERS REPAIRED and calibrated. Free estimates. **BIGELOW ELECTRONICS**, Bluffton, Ohio.

PATENT SEARCHES, \$6.00! Free "Invention Record"/Information.—**MISS HAYWARD**, 1029 Vermont, N.W., Washington 5, D.C.

METER REPAIRS—All makes and models. **BIGELOW ELECTRONICS**, Bluffton, Ohio.

TRANSISTORIZED products dealers catalog, \$1. **INTERMARKET**, CPO 1717, Tokyo, Japan.

ALL MAKES OF ELECTRICAL INSTRUMENTS AND TESTING equipment repaired. **HAZELTON INSTRUMENT CO.**, 128 Liberty St., New York, N.Y.

SPEAKER RECONING. Satisfaction Guaranteed. **C & M RECONE CO.**, 18 W. Trenton Ave., Morrisville, Pa.

TV Tuners—rebuilt or exchanged, \$9.95. Fast, Guaranteed. Complete crystal control alignment. **VALLEY TUNER SERVICE**, 5641 Cahuenga, North Hollywood, Calif.

TV TUNERS REBUILT AND ALIGNED Per manufacturer's specification. Only \$9.50. Any make UHF or VHF. We ship COD. 90-day written guarantee. Ship complete with tubes or write for free mailing kit and dealer brochure. **J. W. ELECTRONICS**, Box 51D, Bloomington, Ind.

WANTED

WRITERS! Wanted how-to electronic book manuscripts and other subjects; fiction, nonfiction. FREE brochures give tips on writing and publishing. Write Dept. 98-D, **EXPOSITION**, 386 Park Avenue So., New York 16, N.Y.

BUILD, SELL ELECTRONIC FIRE AND BURGLAR ALARMS. Send \$2 for sample parts. **EL—TEC**, Box 85, Lake Hiawatha, N.J.

INVESTIGATE ACCIDENTS. Earn \$750 to \$1,000 monthly. Men urgently needed. Car furnished. Business expenses paid. No selling. No college education necessary. Pick own job location. Investigate full time, or earn \$6.44 hour spare time. Write for Free Book. No obligation. **UNIVERSAL**, CER-4, 6801 Hillcrest, Dallas 5, Tex.

CASH PAID! Sell your surplus electronic tubes. Want unused, clean radio and TV receiving, transmitting, special purpose, Magnetrons, Klystrons, broadcast types, etc. Want military & commercial lab/test and communications equipment such as G.R., H.P. AN/UPM prefix. Also want commercial receivers and transmitters. For a fair deal write **BARRY**, 512 Broadway, New York 12, N.Y. WALKER 5-7000.

G-R, H-P, L&N, etc., Tubes, manuals, military electronics. **ENGINEERING ASSOCIATES**, 434 Patterson Road, Dayton 19, Ohio.

EDUCATION/INSTRUCTION

SECRETS OF SUCCESS: Why be unsuccessful? Send \$1.00 for this great book. **MIRACLE BOOK CO.**, Box 816, Laredo, Tex.

LEARN WHILE ASLEEP. Hypnotize with your recorder, phonograph or amazing new Electronic Educator endless tape recorder. Catalog, details free. **SLEEP-LEARNING ASSOCIATION**, Box 24-RD, Olympia, Wash.

NEW CONCEPT OF LEARNING SELF-HYPNOSIS! Now on tape or record! Free literature. **McKINLEY-SMITH CO.**, Dept. T5, Box 3038, San Bernardino, Calif.

FCC LICENSE in 6 weeks, First Class Radio Telephone. Results Guaranteed. **ELKINS RADIO SCHOOL**, 2603E Inwood, Dallas, Tex.

LEARN ELECTRONIC ORGAN SERVICING. New Home Study courses covering all makes electronic organ including transistors. Experimental kits — schematics — troubleshooting. Accredited NHSC-GI Approved. Write for free booklet. **NILES BRYANT SCHOOL**, 3631 Stockton Blvd., Dept. F. Sacramento 20, Calif.

LEARN HYPNOSIS. Free illustrated catalogue. Write: **HYPNOTIST**, 8721 Sunset, Los Angeles 69RE, Calif.

COLLEGE HOME Study Courses from leading universities. Full credit towards Bachelor's or Master's degree. 5,000 course directory \$2.00. **COLLEGE RESEARCH**, North Highlands 14, Calif.

PIANO TECHNIC Simplified. \$1.25. **WALTER KAZAKS**, 234 E. 58th St., New York 22, N.Y.

FOR SALE**General**

GOVERNMENT SURPLUS. How and where to buy in your area. Send \$1.00 **SURPLUS INFORMATION**, RE, Headquarters Building, Washington 6, D.C.

BEFORE You Buy Receiving Tubes, Test Equipment, Hi-Fi Components, Kits, Parts, etc. . . . send for your Giant Free Zalytron Current Catalog, featuring all STANDARD BRAND TUBES all Brand New Premium Individually Boxed, One Year Guarantee—all at BIGGEST DISCOUNTS in America! We serve professional servicemen, hobbyists, experimenters, engineers, technicians, WHY PAY MORE? **ZALYTRON TUBE CORP.**, 461 Jericho Turnpike, Mineola, N. Y.

FREE CATALOG—name-brand tubes 65% discount, phono needles 80% or more discount,

phono cartridges, picture tubes 75¢ inch, parts, parts kits, silicon and selenium rectifiers, transmitting tubes, 7" TV test tube \$6.99, imported batteries, tube testers etc. Want to swap or sell tube inventory? Send us your offering. **ARC-TURUS ELECTRONICS CORP.**—Dept. R.E., 502 22nd St. Union City, N. J.

Electronics

TRANS-NITION Electronic Ignition parts kit, Negative ground \$25. Coil, Manual SPECIAL \$8.50. Manual \$2. **ANDERSON ENGINEERING**, Wrentham, Mass.

GOVERNMENT SURPLUS. Jeeps—\$223.83, Transmitters—\$6.18, Receivers—\$5.65, Typewriters—\$4.15, Oscilloscopes, Multimeters, Speakers, Walkie—Talkies. Typical Government Surplus prices. Exciting details FREE. **N.Y. ENTERPRISES**, Box 402-F15, Jamaica 30, N.Y.

RESISTORS: 1/2-Watt 3¢, 1-Watt 4¢, 2-Watt 6¢. **T. J. SOUND STUDIOS**, 139 Pugsley Avenue, Bronx 72, N.Y.

CB TRANSMITTERS \$6.00. Other bargains, send 10¢ for list. **VANGUARD**, 190-48—99th Ave., Hollis 23, N.Y.

RADAR: Largest surplus stock in the world. **RADIO RESEARCH INSTRUMENT CO.**, 550 Fifth Avenue, New York 36, N.Y.

SCHEMATICS FOR TV, RADIO. \$1.00. **DEES ELECTRONICS**, 5945 Beverly Lane, RR #2, Middletown, Ohio.

BARGAIN PRICES ON SLIGHTLY USED TEST EQUIPMENT. Send for free list and prices. **CENTURY ELECTRONICS**, 352 Maple Ave., Westbury, N.Y.

SAVE DOLLARS on radio, TV tubes, parts at less than manufacturer's cost. 100% guaranteed! No rebrand, pulls. Request Bargain Bulletin. **UNITED RADIO**, 1000-R, Newark, N.J.

DIAGRAMS for TV, \$2.00; for radio, \$1.00. **HIETT DIAGRAMS**, Box 816, Laredo, Tex.

PROFESSIONAL ELECTRONICS PROJECTS—Organs, Timers, Computers, etc.—\$1 each. List free. **PARKS**, Box 1665, Lake City, Seattle 15, Wash.

SUPERSENSITIVE DIRECTIONAL MICROPHONE picks up faint sounds at 300 feet. Detects sound through ordinary walls. Easily built for \$7.00. No electronic experience necessary. Illustrated plans, \$2.00. **DEE CO.**, Box 7263-A, Houston 8, Tex.

CONVERT ANY TELEVISION TO SENSITIVE, Big-screen oscilloscope. Only minor changes necessary. Plans \$1.95. **RELCO**, Box 10563, Houston 18, Tex.

PRECISION RESISTORS, carbon-deposit. Guaranteed 1% accuracy. Millions in stock. 1/2 watt, 8¢. 1-watt, 12¢. 2-watt, 15¢. Leading manufacturers. **ROCK DISTRIBUTING CO.**, 902 Corwin Rd., Rochester 10, N.Y.

DIAGRAMS FOR REPAIRING RADIOS, \$1.25; television \$2.50. Give make and model. **DIAGRAM SERVICE**, Box 672 El, Hartford 1, Conn.

EXPERIMENTER'S CRYSTAL-TRANSISTOR "Radio Workbench Tips" handbook 50¢. Catalog. **LABORATORIES**, 1131-B Vaiota, Redwood City, Calif.

WALKIE-TALKIE RADIOS: Citizens Band equip; Intercoms; Radio-TV parts. FREE Catalogue. **ALLEN ELECTRONICS**, 41-42C Main, Flushing 55, N.Y.

RADIO-ELECTRONICS

WEBSTER ELECTRIC INTERCOMS! Amateur Equipment! Marine Electronics! All Select Bargains! 10¢ Any list! **SUPPLIERS**, 187 Miraloma, Miraloma, Calif.

ELECTRONIC SYMBOLS IN RUBBER STAMP FORM, for students and hobbyists, send postcard for details, **ARROW HEART INDUSTRIES**, Box 4925, Detroit 19, Mich.

Audio—Hi-fi

INTERESTED IN NEW ELECTRONIC MUSICAL INSTRUMENTS? Send for free copy of "MoogMusic" to **R. A. MOOG CO.**, Dept. J, Box 263, Ithaca, N.Y.

WRITE for our low quotation on components, recorders. FREE catalog. **HI-FIDELITY SUPPLY**, 2817-XC, Third Ave., New York City 55.

TAPE recorders, Hi-Fi components, Sleep-learning equipment, Tapes, Unusual values. Free catalog. **DRESSNER**, 1523 Jericho Turnpike, New Hyde Park 5, N.Y.

RENT STEREO TAPES—over 2,500 different—all major labels—free catalog. **STEREO-PARTI**, 811-RE, Centinela Ave., Inglewood 3, Calif.

SALE ITEMS—tapes—recorders—component quotes. **BAYLA**, Box 131-RE, Wantagh, N. Y.

4/TR STEREO TAPES—bought, sold, rented, traded! Bargain closeouts! Catalog/**COLUMBIA**, 9651 Foxbury, Rivera, Calif.

STEREO TAPES FOR RENT. Write **NATIONAL TAPES**, 71 Dey St., New York 7, N.Y.

MISCELLANEOUS

WORLD'S LOWEST PRICE LIST—U. S.—Mint and Used—priced per one—get yours now!! FREE! **WILLIAM RICE**, 10230-S, Martinique Dr., Miami 57, Fla.

\$100 WEEKLY POSSIBLE. Compile mailing lists and address envelopes for advertisers. Home-spare time. Particulars free. **NATIONAL SERVICE**, 81 Knickerbocker Station, New York, N. Y.

MAKE \$25-\$50 WEEK CLIPPING newspaper items for publishers. Some clippings worth \$5.00 each. Particulars free. **NATIONAL**, 81 Knickerbocker Station, New York N. Y.

HUNDREDS Moneymaking Opportunities. Free Copy. **POPULAR MECHANICS**, 740-CV Rush, Chicago 11, Ill.

PRINTING PRESSES, Type, Supplies. Lists 5¢. **TURNBAUGH SERVICE**, Mechanicsburg, Pa.

LOCATE ANY BOOK. No Obligation. **BOOK-FINDERS**, Box 668-RE, San Diego 12, Calif.

BUSINESS AIDS

BUSINESS CARDS, LABELS, RUBBER STAMPS. Send for free descriptive literature, **HEIGHTS INDUSTRIES**, 6121 C Street, Capitol Heights 27, Md.

QUALITY RUBBER STAMPS, Moderate prices. FREE Catalog. **MELCO**, Box 53331-RE, New Orleans 50, La.

LETTERHEADS, BILLHEADS, STATEMENTS, ENVELOPES—Complete set \$9.95 postpaid—two color \$12.95 (Samples). **OKAYPRINT**, Martins Ferry 3, Ohio.

1,000 Business Cards, "Raised Letters" \$3.75 postpaid. Samples. **ROUTH**, RE-4, 3910 Kipling, Greensboro, N. C.

(Continued from page 102)

surplus receivers and transmitters, antennas, miscellaneous accessories and station layout.

1962 RADIO REGISTRY—TRANSPORTATION RADIO SYSTEMS. *Radio Magazines, Inc.*, P. O. Box 629, Mineola, N. Y. 8½ x 11 in. 116 pp. \$5.00. (Registries of Business and Miscellaneous, Public Safety and Industrial Radio Services \$7.00, \$6.00 and \$7.00, respectively.)

Listings of pertinent data on stations in the Land Transportation Radio Service (taxicabs, railroads, auto emergency and motor carriers). Part 1 lists licensees under geographical location and type of operation, location of each fixed transmitter, number of mobile and portable units authorized, operating frequencies, call letters and make of equipment. Part 2 is a listing by frequencies. It shows call letters, location of transmitters and type of operation.

RF INTERFERENCE CONTROL HANDBOOK by Barron Kemp. *Howard W. Sams & Co., Inc.*, 1720 E. 38 St., Indianapolis 6, Ind. 5½ x 8½ in., 224 pp. Cloth \$6.95.

Theory, measurements and suppression of interference caused by switches, motors, ignition systems and other equipment.

TECHNICAL TELEVISION, by A. V. J. Martin. *Prentice-Hall, Inc.*, Englewood Cliffs, N. J. 6 x 9 in., 557 pp. Cloth, \$14.65.

Suitable for technical schools and self-study, this comprehensive and detailed book covers circuits and techniques (including color) with a minimum amount of math.

FUNDAMENTALS OF MODERN SEMICONDUCTORS, by Barron Kemp and R. H. McDonald. *Howard W. Sams & Co. Inc.*, 1720 E. 38 St., Indianapolis 6, Ind. 5½ x 8½ in. 160 pp. Paper, \$2.95.

Describes the fabrication, theory and use of various types of transistors, diodes, phototransistors and parametric devices.

PRINTED CIRCUITS IN SPACE TECHNOLOGY, by Albert E. Linden. *Prentice-Hall Inc.*, Englewood Cliffs, N. J. 6 x 9 in. 197 pp. Cloth, \$9.

Comprehensive coverage of design, test and production techniques to obtain maximum reliability at minimum cost.

UNDERSTANDING TRANSISTORS AND HOW TO USE THEM. *Allied Radio Corp.*

Our review of this book (February 1963, p. 119) quoted the price as \$3.90. The correct price is 50¢. END



"All right, Harry, let's hear this great speaker you've been telling me about."



COYNE
TRAINS YOU
IN SPARE TIME
AT HOME

TELEVISION

**COLOR TV—
RADIO—ELECTRONICS**

Only from famous COYNE do you get this modern up-to-the minute TV Home Training. Easy to follow instructions—fully illustrated with 2150 photos and diagrams. Not an old Radio Course with Television tacked on. Includes *UHF* and *COLOR TV*. Personal guidance by Coyne Staff. *Practical Job Guides* to help you **EARN MONEY QUICKLY IN A TV-RADIO SALES AND SERVICE BUSINESS—part time or full time. COSTS MUCH LESS—pay only for training—no costly "put together kits."**

SEND TODAY FOR FREE BOOK

SEND COUPON or write to address below for *Free Book* and full details including **EASY PAYMENT PLAN. NO COST OR OBLIGATION—NO SALESMAN WILL CALL.**



B. W. COYNE
Pres.

COYNE
ELECTRICAL SCHOOL

FOUNDED 1899

CHARTERED AS AN EDUCATIONAL INSTITUTION NOT FOR PROFIT
1501 W. Congress Pkwy. Dept. 43-H5, Chicago 7, Ill.

COYNE Television Home Training Div.
New Coyne Building, Dept. 43-H5,
1501 W. Congress Pkwy., Chicago 7, Ill.

Send FREE BOOK and details of your Television Home Training offer.

Name _____
Address _____
City _____ State _____

AMAZING

**TV
LIFE-SAVER®**
ONLY \$4.95



U.S. Pat. 2,914,637

Eliminates Costly TV Troubles

By absorbing damaging in-rush current so destructive to Television and Hi-Fi tubes, the TV LIFE-SAVER eliminates 3 out of 4 Service calls by more than tripling the life of all tubes . . .

PROTECTION



Model 4100-2, 100-275 watts 117 V. \$1.95 List
Model 8050-4, 250-400 watts 117 V. \$2.95 List

WUERTH SURGISTOR®

A new component easily installed to reduce call-backs by eliminating surge current damage to television and Hi-Fi tubes.

See your dealer or distributor today for these money saving, equipment saving Miracle Inventions. Or, send your order direct to us for prompt action.

WUERTH PRODUCTS CORP.
1931 Moffett St., Hollywood, Florida

HEAR before you BUILD

a beautiful

Schober

ELECTRONIC

ORGAN



Console Model

HEAR the superior quality of the rich, full Schober tone—
a FREE 7-inch record is yours, without obligation!

SAVE MORE THAN 50% when you BUILD YOUR OWN magnificent Schober Organ—easy-to-assemble components fit right into a handsome ready-made cabinet!

We are proud of the fact that many people who could well afford to buy any organ, have chosen to build a Schober Organ simply because they prefer it musically. We'd like you to share the thrilling experience of hearing the marvelous tone quality of a Schober Electronic Organ. Now you can receive—*absolutely free and without any obligation*—a brief demonstration record of the superb, full-range sound of Schober Organs.

We invite you to listen and compare—compare the quality, compare the cost. You can build your own Schober Organ for less than half the price of a comparable, ready-made organ. And you can choose from 3 full-size, authentic organ models.

- Spinnet Model \$550
- Console Model \$800
- Concert Model \$1200

You don't have to know the first thing about electronics or music to assemble a Schober Organ. Clear, concise, step-

by-step instructions guide you from start to finish. It's really easy and it can take as little as 50 hours, depending on which model you choose. You can order a complete set of kits and receive all the parts for your organ at once. Or you can start by ordering just the first unit, and we'll send additional components whenever you're ready for them. That way you spend only a small amount of money at a time—for example, only \$18.94 for your first kit.

Even a beginner can quickly learn to play a Schober Organ, because millions of adults have found that the organ is the easiest instrument of all. Learning is fun. Send for your record now. You'll also receive an informative booklet giving full details about buying, building, and playing your Schober Electronic Organ.

THE Schober Organ CORPORATION

43 West 61st Street, New York 23, N. Y.

IN CANADA: Associated Music Services
216 Alverna Road
Richmond Hill, Ontario

IN AUSTRALIA: The Electronic Organ Co.
(Australia)
11 Cadow Street
Pymble, N. S. W.

IN UNITED KINGDOM: Burge Electronics Limited
Greycaines Industrial Estate
Bushey Mill Lane, Watford
Hertfordshire, England

TO GET YOUR FREE
RECORD MAIL
THIS COUPON TODAY



The Schober Organ Corp., Dept. RE-24
43 West 61st Street
New York 23, N. Y.

Please send me—without cost or obligation—my 7" record of Schober Organ music, with full descriptive literature.

Name _____

Address _____

City _____ Zone _____ State _____

NAME OF ADVERTISERS

Acoustic Research Inc.	99
Allied Radio	92
Anglo American Acoustics Ltd.	87
Arco Electronics, Inc. (Elenco Div.)	18
Arrow Fastener Co., Inc.	96
Artisan Organs	92
ATR Electronics, Inc.	84
B & K Manufacturing Co.	57
Blonder-Tongue Labs.	59
Brooks Radio & TV Corp.	86-87
Capitol Radio Engineering Institute	19
CREI Atomics (Div. of the Capitol Radio Engineering Institute)	80
Carston	92
Castle TV Tuner Service	12
Centralab Div. of Globe-Union	79
Century Electronics	85
CLASSIFIED ADS	104-105
Cleveland Institute of Electronics	9
Colordaptor	100
Conar Instruments Div. of National Radio Institute	54, 98
Cornell Electronics Co.	98
Coyne Electrical School	105
Coyne School Publications	85
Denson Electronics Corp.	92
DeVry Technical Institute	7, 82
Dressner	92
Editors & Engineers	76
EICO (Electronic Instrument Co.)	22
Electro-Voice Inc.	13
Electronic Chemical Corp.	90
Electronic Measurement Corp. (EMC)	66
Electronic Publishing Co., Inc.	90
Fair Radio Sales	96
GM Photoelectronics	101
Gernsback Library Inc.	97
(R. E.) Goodheart Co., Inc.	96
Grantham School of Electronics	11
Heald's Engineering College	101
Heath Company	77
I-Triple-E	84, 94, 98, 102
International Crystal Mfg. Co. Inc.	83
International Resistance Co.	21
JFD Electronics Corp.	53
(E. F.) Johnson Co.	94
Key Electronics Co.	101
Lafayette Radio	89
(P. R.) Mallory Co. Inc.	55
Mercury TV Tuner Service	76
Moss Electronic Inc.	96
Multicore (Div. of British Industries)	87
National Radio Institute	15-16, 103
National Technical Schools	5
North American Philips Co. Inc. (Norelco)	78
Polypaks	93
Progressive Edu-Kits Inc.	95
RCA (Electron Tube Div.)	Back Cover
RCA Institutes	73-75
Rad-Tel Tube Co.	81
Reeves Soundcraft Corp.	3
Relco	92
(John F.) Rider Publisher Inc.	88
Rohn Manufacturing Co.	8
(Howard W.) Sams & Co., Inc.	56, 68-69
Schober Organ Co.	106
(H. H.) Scott Inc.	101
Secore	17
Sprague	91
Standard Kollsman Industries Inc.	3rd Cover
Sylvania Electric Products Inc.	62-63
T A B	102
(Sarkes) Tarzian Inc. (Tuner Div.)	20
(Sarkes) Tarzian Inc. (Tape Div.)	71
Terado Corp.	102
Triad Distributor Div.	67
Triplett Electrical Instrument Co.	2nd Cover
University Loudspeakers Inc.	10
Utah Electronics Corp.	14
Warren Electronics Co.	100
Wen Products Co.	70
Winegard Co.	65
Workman Electronic Products Inc.	87
Wuerth Products Corp.	105
SCHOOL DIRECTORY	page 103
Central Technical Institute	
Electronic Technical Institute	
Indiana Institute of Technology	
International Correspondence Schools	
Milwaukee School of Engineering	
Northrop Institute of Technology	
Pacific International College of Arts & Sciences	
Tri-State College	
Valparaiso Technical Institute	

Printed in USA.

RADIO-ELECTRONICS



STANDARD KOLLSMAN BRINGS

Beauty TO UHF CONVERTERS

The Model "A", the only UHF converter you can show and sell with pride. Designer styled in beige and tan to blend with today's decor . . . to harmonize with modern TV cabinet design. Standard waited . . . and tested, analyzed, and re-tested until they could bring you the quality instrument you and your customers have a right to expect from the leading manufacturer of tuners. As a result, you now have a converter which is beautiful, profitable, and dependable.

Contact your Standard representative . . . or write

standard kollman INDUSTRIES, INC.

Formerly Standard Coil Products Co., Inc., Melrose Park, Illinois / WORLD'S LARGEST MANUFACTURER OF TELEVISION TUNERS

PERFORMANCE YOU CAN SEE

New low-noise, shielded tuner permits fine tuning for all 83 UHF channels. Functions perfectly with color or black and white sets. Two simple controls: one for VHF, UHF, and "off" . . . the other for channel selection and fine tuning. The "SK" installs in about a minute with just a screw-driver.



Feature this exciting counter-top display carton

POWER IN PROMOTIONAL

SUPPORT With a first order of 12 units or more, Standard supplies 3 newspaper ad mats . . . 3 radio spot scripts . . . materials for a powerful TV spot . . . 2-color catalog sheets . . . a giant (3' x 6') 2-color window banner . . . a counter card . . . as many pre-printed jumbo post cards as you can use PLUS hard hitting ads in TV Guide.

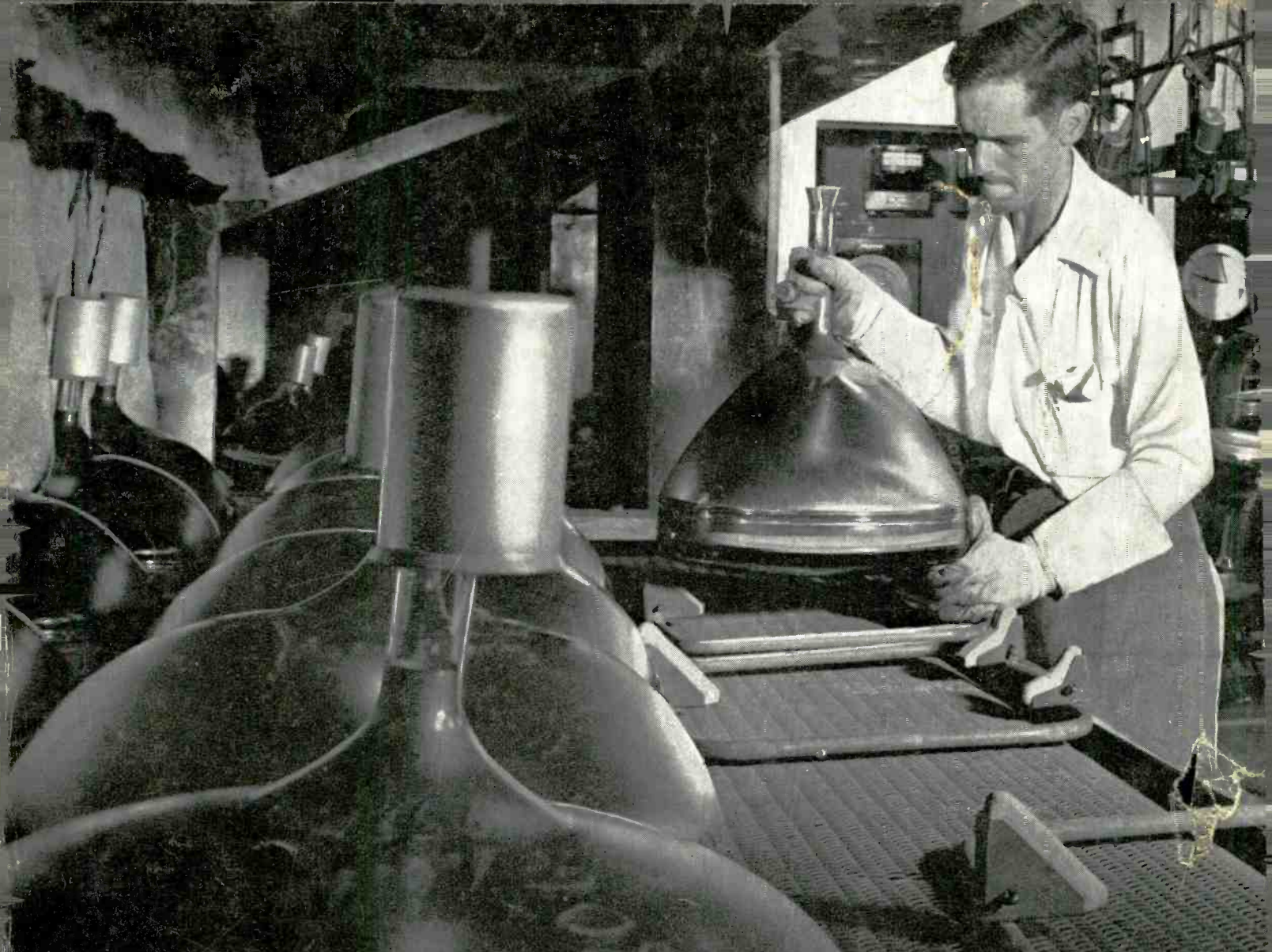

HOW RCA BAKES OUT CALLBACKS

Oven-drying Silverama® bulbs improves performance, prolongs life

You are looking from-inside-out of a Lehr oven—a high-temperature “picture tube kiln” designed to bake potential troubles out of Silverama picture tube bulbs.

This oven—in our Marion, Indiana picture-tube plant—bakes aluminized picture-tube bulbs for 2½ hours; peak temperature during bake out: 460°C. Objective? Bake out all moisture and decompose all organic material that might short-

en the life of the tube or otherwise affect its performance.

This long bake-out also produces favorable stresses in the glass itself to increase strength and long life. It is but one of many stringent manufacturing steps taken to assure the high quality standards of RCA Silverama. Result: substantial reductions in callbacks and in-warranty picture tube failures when you install RCA Silverama.

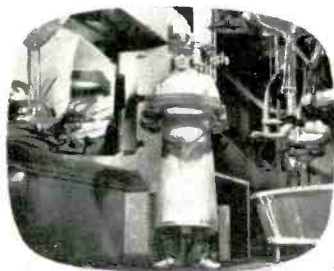

Envelope Inspection. After a series of acid baths the re-used envelope is thoroughly inspected to make sure it meets the standards of an original new envelope.

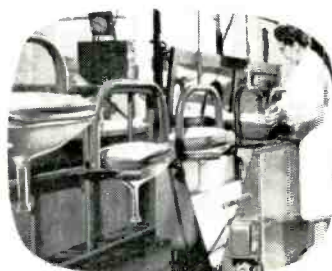

Screen Quality Inspection. After rescreening, each bulb undergoes rigorous inspection for screen quality. A strong reflected light behind the bulb reveals even the smallest flaws in the screen; even the smallest is cause for rejection of the bulb.

RCA ELECTRON TUBE DIVISION, HARRISON, N. J.



The Most Trusted Name in Television